

# Design Manual Revisions

The following general revisions have been made throughout the Roadway Design Manual:

Section	Summary of General Revision(s)
Cover, title page, footers	Updated revision date to May 2024
<a href="#">13.11</a>	*** New <b>Roadway Submittal Guidelines</b> have been incorporated into this Roadway Design Manual Update. These submittal guidelines supersede the October 2015 <i>Guidelines to be Used by Consultants for Producing Roadway Plans</i> . Changes were made to remove information from parts of Sections 12, 13, and 15 to avoid duplicated or conflicting guidance. ***

The following sections of the Roadway Design Manual have been revised to provide clarification and/or new guidance on current design practice:

Section	Summary of Revision(s)
<a href="#">Part I Overview</a>	Revised common design practice guidance
<a href="#">2.10</a> , <a href="#">2.10.1</a> , <a href="#">2.10.2</a> , <a href="#">2.10.3</a>	Revised On-site Detour and Median Crossover workflow Streamlined Work Zone Traffic Control guidance
<a href="#">3.5.2</a>	Revised Minimum Grade guidance
<a href="#">4.4.1.1</a> , <a href="#">9.4.1.3</a> , <a href="#">9.4.2.2</a>	Updated shoulder terminology
<a href="#">4.9.1</a>	Added Section 4.9.1 Median Slopes
<a href="#">5.3.2.4</a>	Removed median barrier language or clarity
<a href="#">5.3.8.5</a> <a href="#">5.3.8.6</a>	Revised language for natural and false cuts
<a href="#">5.3.8.10</a>	Changed shoulder rollover under bridges guidance
<a href="#">6.9</a>	Added terminal end section information
<a href="#">8.2.4</a>	Deleted redundant sentence
<a href="#">8.7.2</a> , <a href="#">8.7.2.1</a>	Added language for clarity
<a href="#">8.7.3.1</a>	Added coordination language
<a href="#">9.4.1.4</a>	Add Section 9.4.1.4 Flyover Ramps
<a href="#">9.4.1.6</a>	Added language defining the design speed for values in Table 9-2
<a href="#">9.4.1.8</a>	Changed edge of pavement to edge of travel lane to reflect design practice

Section	Summary of Revision(s)
<a href="#">9.5.4</a>	Added design considerations for left turns and channelization
<a href="#">12.3, 12.3.1, 12.3.2</a>	Removed electronic plan submittal guidance as it's covered in the added Roadway Submittal Guidelines (RDM Section 13.11)
<a href="#">12.3.2</a>	Moved NCDOT Final Plans and Special Provisions reference to RDM Section 12.4 Moved Plan File Renaming Tool reference to RDM Section 13.11.3.9
<a href="#">12.3.3</a>	Moved electronic signatures section to RDM Section 13.11.3.9
<a href="#">12.3.1 (old 12.4.1)</a>	Added Roadway Key Documents RDM section 12.3.1
<a href="#">13.2.10</a> <a href="#">13.2.10.2</a>	Revised municipal boundaries note guidance
<a href="#">13.8.1</a>	Added detour design speed to list of basic information on a plan sheet
<a href="#">13.9.3</a>	Revised language for list of common errors for clarity
<a href="#">13.10</a>	Moved typical Roadway Key Documents to RDM Section 12.3.1 Revised Roadway Supporting Documents and Correspondence lists to be in line with the PS&E checklist Added PS&E checklist reference
<a href="#">13.11</a>	Added RDM Section 13.11 Roadway Submittal Guidelines
<a href="#">13.11.3.10</a>	Added "Document not considered final unless all signatures completed" note guidance
<a href="#">14.2</a>	Added limited and partial control of access guidance in accordance with the March 2024 memo "Non-Motorized Facilities in Partial and Limited C/A". Added a reference to Utilities Accommodation Manual for encroachment guidelines
<a href="#">15.6, 15.6.1</a>	Removed AASHTOWare Project and PIQ Tool guidance as the information is covered in the added Roadway Submittal Guidelines (RDM Section 13.11) Added a reference to RDM Section 13.11.3.10
<a href="#">16.4.2</a>	Changed Lighting to Underpass lighting for clarity
<a href="#">17.8</a>	Updated Design Exception Request Form letters in the Example Forms section

The following tables in the Roadway Design Manual have been revised:

Table	Summary of Revision(s)
<a href="#">Acronyms and Abbreviations</a>	Revised table to update list of relevant acronyms and abbreviations
<a href="#">3-5</a>	Revised superelevation guidelines
<a href="#">4-6</a>	Revised * note for median width

<b>Table</b>	<b>Summary of Revision(s)</b>
<a href="#">4-7</a>	Added Table 4-7 Recommended Maximum Median Slopes. Table 4-8 was renumbered automatically
<a href="#">9-2</a>	Added the Desirable Radius column
<a href="#">13-1</a>	Added OSM-Series for On-site mitigation plans and removed NS-Series
<a href="#">13-3</a> , <a href="#">13-4</a>	Revised S4.75A information to match 2024 QMS manual
<a href="#">13-6</a> , <a href="#">13-7</a> , <a href="#">13-8</a> , <a href="#">13-9</a>	Added tables with the inclusion of the Roadway Submittal Guidelines

The following figures in the Roadway Design Manual have been revised:

<b>Figure</b>	<b>Summary of Revision(s)</b>
<a href="#">5-3</a>	Revised Note 2
<a href="#">5-13</a>	Removed original Figure 5-14 due to merging of information into Figure 5-13
<a href="#">5-13</a> thru <a href="#">5-18</a>	Revised figures to remove auxiliary lane, changed shoulder pier to bridge abutment, and revised notes
<a href="#">5-21</a>	Cleaned up drafting
<a href="#">5-24</a>	Revised column headings to match Standard Drawings 560.01 and 560.02
<a href="#">8-11</a>	Revised notes and column heading
<a href="#">8-12</a>	Revised figure for 23' median
<a href="#">8-13</a> thru <a href="#">8-15</a>	Revised notes for the figures
<a href="#">9-2</a>	Revised figure to reflect control point locations

# Roadway Design Manual

Implementation Date: November 1, 2021

Revised ~~November 2023~~ May 2024

## Acknowledgements:

The time and effort provided by the Roadway Design Manual Committee members, content developers and reviewers are greatly appreciated.



This page intentionally left blank.

# Contents

<b>Acronyms and Abbreviations .....</b>	<b>xvi</b>
<b>Part I General Design Information .....</b>	<b>1-1</b>
<b>Part I Overview .....</b>	<b>1-3</b>
<b>Chapter 1 Framework for Geometric Design.....</b>	<b>1-1</b>
1.1 Introduction .....	1-1
1.2 Overview of the Roadway Design Manual.....	1-1
1.3 Multimodal Considerations.....	1-1
1.4 Design Process to Address Specific Project Types .....	1-2
1.5 Purpose and Need.....	1-2
1.5.1 New Construction .....	1-3
1.5.2 Reconstruction Projects.....	1-4
1.5.3 Existing Roadway Construction .....	1-4
1.6 Project Cost Reduction Guidelines.....	1-4
1.6.1 Avoid Overdesign .....	1-5
1.6.2 Cross Section.....	1-5
1.6.3 Earthwork .....	1-5
1.6.4 Right of Way.....	1-6
1.6.5 Drainage.....	1-6
1.6.6 Pavement Design .....	1-6
1.6.7 General .....	1-6
<b>Chapter 2 General Design Criteria .....</b>	<b>2-1</b>
2.1 Design Policy Interpretation .....	2-1
2.2 Selection of Design Criteria.....	2-1
2.2.1 Functional Classifications .....	2-2
2.2.2 Context Classifications .....	2-4
2.2.3 Design Speed.....	2-5
2.3 Terrain Classifications.....	2-6
2.4 Highway Capacity .....	2-7
2.4.1 Traffic Characteristics.....	2-8
2.4.2 Definitions .....	2-8
2.4.3 Average Daily Traffic (Current and Future Year).....	2-9
2.4.4 General Guidelines for Roadway .....	2-9
2.5 Access Control and Access Management.....	2-10
2.6 Pedestrians, Bicyclists and Transit.....	2-10
2.6.1 Complete Streets.....	2-10
2.6.2 Design Guidance.....	2-11
2.7 Typical Section Selection .....	2-15
2.7.1 Selecting a Typical Section .....	2-15
2.7.2 Lane Widths (Shoulder Sections) .....	2-15
2.7.3 Lane Widths (Curb & Gutter Sections).....	2-16
2.7.4 Pavement Cross Slope.....	2-16
2.7.5 Pavement Composition .....	2-16
2.7.6 Existing Pavement.....	2-17
2.7.7 Pavement Edge Construction .....	2-17
2.8 Safety .....	2-18

2.9	Environment.....	2-18
2.10	Design of On-Site Detours and Median Crossovers .....	2-19
2.10.1	Interstate and Freeways .....	2-20
2.10.2	Expressways and Major Arterials .....	2-21
2.10.3	Minor Arterials, Collectors, and Local Roads .....	2-22
2.11	Off-Site Detours .....	2-22
<b>Chapter 3 Design Elements.....</b>		<b>3-1</b>
3.1	Introduction .....	3-1
3.2	Sight Distance.....	3-1
3.2.1	General Considerations.....	3-1
3.2.2	Stopping Sight Distance .....	3-1
3.2.3	Decision Sight Distance.....	3-2
3.2.4	Passing Sight Distance.....	3-2
3.3	Horizontal Alignment.....	3-3
3.3.1	General Considerations.....	3-3
3.3.2	Spiral Curves.....	3-3
3.3.3	Traveled Way Widths .....	3-4
3.3.4	Widths for Turning Roadways at Intersections.....	3-7
3.4	Superelevation.....	3-8
3.5	Vertical Alignment.....	3-8
3.5.1	Maximum Grades .....	3-9
3.5.2	Minimum Grades .....	3-9
3.5.3	Vertical Curves.....	3-9
3.5.4	Design Controls for Vertical Curves.....	3-9
3.5.5	Climbing Lanes.....	3-10
3.5.6	Emergency Escape Ramps .....	3-10
3.5.7	Pedestrian Considerations .....	3-10
<b>Chapter 4 Cross Section Elements.....</b>		<b>4-1</b>
4.1	General.....	4-1
4.2	Traveled Way.....	4-1
4.3	Lane Widths.....	4-1
4.4	Shoulders .....	4-2
4.4.1	Shoulder Widths .....	4-2
4.4.2	Shoulder Width on Loops .....	4-4
4.4.3	Shoulder Width on Ramps.....	4-4
4.4.4	NCDOT Paved Shoulder Guidance .....	4-4
4.4.5	Shoulder Slopes .....	4-6
4.4.6	Sideslopes.....	4-9
4.4.7	Rumble Strips.....	4-10
4.5	Traffic Management Plan and Work Zone Traffic Control.....	4-11
4.6	Roadside Design.....	4-12
4.6.1	Clear Zones.....	4-13
4.6.2	Vehicle Recovery Areas .....	4-15
4.6.3	Lateral Offset.....	4-17
4.7	Curbs.....	4-17
4.8	Glare Screens.....	4-18
4.9	Medians .....	4-20
4.9.1	Median Slopes.....	4-21
4.9.2	Median Crossovers .....	4-21

4.9.3	Spread Median .....	4-26
4.10	Service Roads .....	4-27
4.10.1	Service Road Study.....	4-27
4.11	Cul-de-Sacs .....	4-27
4.12	Roadside Control .....	4-27
4.12.1	Driveways.....	4-28
4.12.2	Mailboxes .....	4-30
4.12.3	Fencing .....	4-30
4.13	Tunnels.....	4-30
4.14	Pedestrian Facilities.....	4-31
4.14.1	Sidewalks and Berms .....	4-31
4.14.2	Grade Separated Pedestrian Crossings .....	4-33
4.14.3	Curb Ramps .....	4-34
4.14.4	Stairs.....	4-34
4.15	Bicycle Facilities.....	4-34
4.15.1	Shared Lanes.....	4-35
4.15.2	Bicycle Boulevards .....	4-35
4.15.3	Bicycle Lanes .....	4-35
4.15.4	Buffered Bicycle Lanes.....	4-36
4.15.5	Separated Bicycle Lanes.....	4-36
4.16	Transit Facilities .....	4-36
4.17	On-Street Parking .....	4-37
<b>Chapter 5</b>	<b>Structures.....</b>	<b>5-1</b>
5.1	Usage .....	5-1
5.1.1	Exceptions to Guidelines .....	5-1
5.1.2	Existing Bridges to Remain.....	5-1
5.2	Guidelines for Subregional Tier Bridge Projects .....	5-3
5.2.1	Usage.....	5-3
5.2.2	Geometric Design Criteria .....	5-3
5.2.3	Guardrail .....	5-6
5.2.4	Hydraulic Design .....	5-6
5.2.5	Geotechnical Design .....	5-6
5.2.6	Structural Design.....	5-6
5.3	Bridges .....	5-7
5.3.1	Bridge Information in the Design Recommendation Plan Set.....	5-7
5.3.2	Deck Widths for Bridges .....	5-9
5.3.3	Horizontal Clearances for Bridges .....	5-23
5.3.4	Vertical Clearances for Bridges .....	5-42
5.3.5	Geometric Design Considerations at Bridges .....	5-45
5.3.6	Guidelines for Cored Slab and Box Beam Bridge Spans .....	5-47
5.3.7	Bridge Constructability Guidelines .....	5-48
5.3.8	Grading and Roadside Design Under Bridges .....	5-49
5.3.9	Bridges Approaches .....	5-65
5.3.10	Attachments to Bridges .....	5-67
5.3.11	Barrier Rails and Sidewalks.....	5-68
5.4	Structures in Multimodal Facilities .....	5-68
5.5	Retaining Walls.....	5-69
5.5.1	Types of Retaining Walls.....	5-69
5.5.2	Identification, Layout, and Investigation of Retaining Walls .....	5-72
5.5.3	Geometric Design and Protection of Retaining Walls .....	5-73

5.5.4	Request for Retaining Wall Design .....	5-80
5.5.5	Temporary Shoring.....	5-81
5.6	Sound Barrier Walls .....	5-81
5.7	Drainage at Bridges .....	5-82
5.7.1	Bridge Deck Drainage .....	5-82
5.7.2	Bridge Approach Drainage .....	5-83
<b>Chapter 6</b>	<b>Roadside Barriers .....</b>	<b>6-1</b>
6.1	General Considerations .....	6-1
6.2	Longitudinal Barriers .....	6-1
6.2.1	Barrier Warrants .....	6-1
6.2.2	Length of Need.....	6-3
6.3	Guardrail Placement .....	6-4
6.3.1	Placement on Approach End of Rigid Obstacle Warrant.....	6-4
6.3.2	Placement on Trailing End of Rigid Obstacle.....	6-5
6.3.3	Placement on Approach and Trailing End of Fill Slope Warrants.....	6-6
6.3.4	Placement on Approach End of a Hazard Located on a Curve.....	6-9
6.3.5	Placement for Median Breaks.....	6-9
6.3.6	Placement at Intersections .....	6-9
6.3.7	Placement on -Y- Lines and Interchange Bridges.....	6-10
6.3.8	Placement Adjacent to Curb and Gutter .....	6-10
6.3.9	Placement Under Bridges.....	6-10
6.3.10	Placement on Proposed Structures/Culverts .....	6-11
6.3.11	Placement on Bridge Approaches .....	6-11
6.3.12	Placement on Existing Structures .....	6-11
6.3.13	Temporary Guardrail Placement.....	6-12
6.4	Concrete Barriers.....	6-12
6.4.1	Positively Anchored Temporary Precast Concrete Bridge Barrier – Type S .....	6-12
6.5	Cable Barriers.....	6-13
6.6	Safety vs. Cost Guidance.....	6-13
6.7	Guardrail and Guiderail Summaries .....	6-14
6.8	Median Barrier Selection.....	6-14
6.8.1	Guidelines for Typical Median Guardrail or Guiderail Installation.....	6-15
6.9	Guardrail End Units.....	6-19
<b>Chapter 7</b>	<b>Drainage .....</b>	<b>7-1</b>
7.1	Drainage Considerations for Strategic Transportation Corridors .....	7-1
7.2	PDN Process and Drainage Design .....	7-1
7.2.1	Alignment Defined PDN Stage 2 .....	7-1
7.2.2	Plan-in-Hand PDN Stage 3.....	7-2
7.2.3	Plans, Specifications and Estimate PDN Stage 4 .....	7-2
7.3	Vertical Clearance and Other Grade Considerations.....	7-2
7.3.1	Cut Ditch Sections.....	7-2
7.3.2	Curb and Gutter Sections .....	7-2
7.3.3	Vertical Clearance for Pipes .....	7-2
7.3.4	Vertical Clearance for Box Culverts .....	7-3
7.4	Skew Angle.....	7-4
7.5	Pipe End Treatment .....	7-5
7.5.1	Pipe End Treatment for Cross Pipes .....	7-5
7.5.2	Pipe End Treatment for Parallel Pipes.....	7-6

7.5.3	Endwalls.....	7-6
7.6	Drainage and Gutter Guidelines.....	7-10
7.6.1	Addressing Erosion on Existing Facilities .....	7-10
7.6.2	Proposed Construction .....	7-10
7.7	Hydroplaning.....	7-11
7.8	Paved Ditches.....	7-12
7.9	Rip Rap for Drainage Ditches .....	7-12
7.9.1	Class A Rip Rap.....	7-12
7.9.2	Class B, Class I and Class II Rip Rap.....	7-12
7.10	Rip Rap at Pipe Outlets.....	7-12
7.11	Geotextile Fabric for Drainage Ditches and Pipe Outlets.....	7-12
7.12	Special Ditches .....	7-12
7.13	Berm Ditches .....	7-13
<b>Chapter 8</b>	<b>At Grade Intersections .....</b>	<b>8-1</b>
8.1	General.....	8-1
8.2	Types of Intersections.....	8-1
8.2.1	Three-Leg Intersections.....	8-1
8.2.2	Four-Leg Intersections.....	8-2
8.2.3	Multi-Leg Intersections .....	8-2
8.2.4	Roundabouts.....	8-2
8.2.5	Reduced Conflict Intersections .....	8-3
8.3	Alignment and Profile.....	8-9
8.4	Intersection Sight Distance .....	8-12
8.5	Design Vehicles .....	8-13
8.6	Turning Roadways and Channelization.....	8-14
8.6.1	Turning Roadways .....	8-14
8.6.2	Channelization.....	8-16
8.6.3	Islands.....	8-17
8.6.4	Superelevation of Turning Roadways at Intersections .....	8-18
8.6.5	Stopping Sight Distance at Intersections for Turning Roadways .....	8-18
8.7	Auxiliary Lanes .....	8-18
8.7.1	General Design Considerations.....	8-18
8.7.2	Deceleration Lanes .....	8-21
8.7.3	Left Turn Maneuvers .....	8-24
8.8	Median Openings.....	8-30
8.9	Indirect Left Turns and U-Turns .....	8-30
8.10	Roundabout Design .....	8-30
8.10.1	Geometric Elements.....	8-31
8.10.2	Fundamental Design Principles .....	8-31
8.10.3	Roundabout Drainage .....	8-31
8.10.4	Designing for Large Trucks at Roundabouts.....	8-31
8.10.5	Roundabout Design Resources.....	8-32
8.11	Other Intersection Design Considerations .....	8-33
8.11.1	Intersection Design Elements with Frontage Roads .....	8-33
8.11.2	Bicyclists .....	8-33
8.11.3	Pedestrians .....	8-33
8.11.4	Driveways.....	8-34
8.12	Railroad – Highway Grade Crossings .....	8-34
8.12.1	Horizontal Alignment at Railroad Crossings.....	8-34
8.12.2	Vertical Alignment at Railroad Crossings.....	8-35

8.12.3	Crossing Design .....	8-35
8.12.4	Sight Distance at Railroad Crossings .....	8-35
<b>Chapter 9</b>	<b>Interchange Design .....</b>	<b>9-1</b>
9.1	Introduction .....	9-1
9.2	Interchange Configurations .....	9-2
9.2.1	Three-Leg Designs .....	9-2
9.2.2	Four-Leg Designs .....	9-2
9.3	General Design Considerations .....	9-5
9.3.1	Alignment, Profile, and Cross Section .....	9-5
9.3.2	Sight Distance .....	9-6
9.3.3	Interchange Spacing .....	9-6
9.3.4	Auxiliary Lanes .....	9-7
9.3.5	Weaving Sections.....	9-7
9.3.6	Collector-Distributor Roads .....	9-7
9.3.7	Control of Access at Interchanges .....	9-7
9.3.8	Pedestrians and Bicyclists at Interchanges.....	9-8
9.4	Ramps .....	9-8
9.4.1	General Ramp Design Considerations .....	9-8
9.4.2	Ramp Traveled Way Widths .....	9-18
9.4.3	Ramp Terminals .....	9-18
9.4.4	Single Lane Free Flow Terminals, Entrances .....	9-27
9.4.5	Single Lane Free Flow Terminals, Exits .....	9-28
9.5	Other Interchange Design Features .....	9-29
9.5.1	Managed Lanes and Transit Facilities .....	9-29
9.5.2	Ramp Metering (also known as On-Ramp Signals) .....	9-29
9.5.3	Pedestrian and Bicycle Accommodations .....	9-29
9.5.4	Median Designs in Interchange Areas .....	9-30
9.5.5	Grading at Interchanges .....	9-30
<b>Chapter 10</b>	<b>Additional NCDOT Design Resources.....</b>	<b>10-1</b>
10.1	Introduction .....	10-1
10.2	Subdivision Roads – Minimum Construction Standards .....	10-1
10.3	Resurfacing, Restoration, and Rehabilitation of Highways and Streets .....	10-1
10.4	Supplemental Street and Driveway Access Guidelines .....	10-1
10.4.1	General Considerations.....	10-1
10.4.2	Technical Design Guidelines .....	10-2
10.4.3	Figures .....	10-6
<b>Part II</b>	<b>Plan Preparation Procedures .....</b>	<b>10-i</b>
<b>Part II</b>	<b>Overview.....</b>	<b>10-iii</b>
<b>Chapter 11</b>	<b>Project Delivery.....</b>	<b>11-1</b>
11.1	Introduction .....	11-1
11.2	Project Delivery Network.....	11-1
11.3	Quality Management Program .....	11-1
<b>Chapter 12</b>	<b>General Plan Information .....</b>	<b>12-1</b>
12.1	Displaying Information and Data .....	12-1
12.1.1	Lettering on Plans .....	12-4
12.1.2	Scale on Plans .....	12-4
12.2	Standard Sheets for Plan Preparation.....	12-4

12.3	Connect NCDOT (SharePoint) .....	12-6
12.3.1	Roadway Key Documents .....	12-7
12.4	Combined and Clustered Projects.....	12-7
12.4.1	Combining State Highway Projects.....	12-7
12.4.2	Clustered State Highway Projects .....	12-9
12.5	Public Involvement Mapping Guidelines.....	12-10
12.5.1	Corridor Public Hearing Maps.....	12-10
12.5.2	Design Public Meeting/Hearing Maps.....	12-10
12.6	Location and Design Approval .....	12-11
12.7	Roadway Aesthetics Review Process .....	12-11
<b>Chapter 13</b>	<b>Plan Preparation .....</b>	<b>13-1</b>
13.1	Introduction .....	13-1
13.2	Title Sheet.....	13-1
13.2.1	Project Identification Numbers.....	13-2
13.2.2	Location and Type of Work.....	13-3
13.2.3	Vicinity Map.....	13-3
13.2.4	Project Layout .....	13-3
13.2.5	Scale .....	13-4
13.2.6	Design Data .....	13-4
13.2.7	Length of Project .....	13-5
13.2.8	Roadway and Hydraulics Engineer's Seal .....	13-6
13.2.9	Firm Logo and Contact Information .....	13-6
13.2.10	Title Sheet Notes.....	13-6
13.3	Index of Sheets, General Notes, and List of Roadway Standard Drawings .....	13-8
13.3.1	Index of Sheets .....	13-8
13.3.2	General Notes .....	13-9
13.3.3	List of Roadway Standard Drawings.....	13-10
13.4	Conventional Symbols .....	13-10
13.5	Typical Sections and Pavement Schedule .....	13-10
13.5.1	Typical Sections .....	13-10
13.5.2	Pavement Schedule .....	13-12
13.5.3	Typical Details and Notes.....	13-16
13.6	Detail Sheets .....	13-16
13.6.1	Roadway Detail Sheets (2B-Series) .....	13-17
13.6.2	Special Detail Sheets not covered by Roadway (2C-Series).....	13-20
13.6.3	Drainage Details (2D-Series).....	13-20
13.6.4	Geotechnical Details (2G-Series) .....	13-21
13.6.5	Geoenvironmental Details (2H-Series) .....	13-21
13.6.6	Noise Wall Envelopes (2N-Series).....	13-21
13.7	Summary Sheets .....	13-21
13.7.1	Miscellaneous Roadway Summaries (3B-Series) .....	13-22
13.7.2	Drainage Summaries (3D-Series).....	13-27
13.7.3	Geotechnical Summaries (3G-Series) .....	13-32
13.7.4	Parcel Index Sheet (3P-Series) .....	13-33
13.8	Plan and Profile Sheets.....	13-33
13.8.1	Plan Sheets.....	13-33
13.8.2	Profile Sheets.....	13-34
13.9	Cross Sections.....	13-34
13.9.1	Cross Section Note for Lump Sum Grading.....	13-35



13.9.2	Cross Section Note for Projects that do not Specify Lump Sum Grading .....	13-35
13.9.3	Backfill for Undercut Note .....	13-35
13.10	Roadway Supporting Documentation .....	13-36
13.10.1	Design Decision Documentation .....	13-38
13.11	Roadway Submittal Guidelines .....	13-38
13.11.1	General information for Submittal Guidelines .....	13-38
13.11.2	Project Delivery Network Submittal Guidelines .....	13-38
13.11.3	Electronic File Submittal Guidelines .....	13-46
<b>Chapter 14</b>	<b>Right of Way .....</b>	<b>14-1</b>
14.1	Introduction .....	14-1
14.2	Selecting the Appropriate Right of Way .....	14-2
14.2.1	Guide for Establishing Proposed Right of Way and Easements .....	14-3
14.3	Right of Way Monuments on Plans .....	14-5
14.3.1	Existing Right of Way .....	14-6
14.3.2	Proposed Right of Way .....	14-6
14.3.3	Control of Access .....	14-7
14.4	Access Points on Partial Control of Access .....	14-8
14.5	Easements .....	14-8
14.5.1	Permanent Easement .....	14-9
14.6	Guidelines for Control of Access Fencing .....	14-10
14.6.1	Types of Fences .....	14-11
14.6.2	Fencing of Rest Areas and Welcome Centers .....	14-12
14.6.3	Fencing of Truck Weigh Stations .....	14-12
14.6.4	Fencing in Proximity to Airports .....	14-13
14.6.5	Fence Locations at Rivers and Streams .....	14-13
14.6.6	Fence Locations at 54 Inches Pipes and Above .....	14-13
14.6.7	Fence Locations at Overpasses .....	14-13
14.7	Fencing outside of the Control of Access .....	14-13
14.8	Early Fencing (Pre-fencing) .....	14-13
14.9	Gates .....	14-13
14.10	Additional Acquisitions .....	14-14
<b>Chapter 15</b>	<b>Estimates and Computations .....</b>	<b>15-1</b>
15.1	Introduction .....	15-1
15.2	Estimate Submittals .....	15-1
15.2.1	Project Initiation (Stage 1) .....	15-1
15.2.2	Alignment Defined (Stage 2) .....	15-2
15.2.3	Plan-in-Hand (Stage 3) .....	15-2
15.2.4	Plans, Specifications, & Estimates (Stage 4) .....	15-3
15.3	Determination of Pay Items .....	15-3
15.3.1	Standard Specifications for Roads and Structures .....	15-3
15.3.2	Standard Provisions .....	15-4
15.3.3	Project Special Provisions .....	15-4
15.3.4	Master Pay Item List .....	15-4
15.3.5	Proprietary Products .....	15-5
15.4	Quantity Calculations .....	15-5
15.4.1	Earthwork .....	15-6
15.4.2	Geotechnical Recommendations for Design and Construction .....	15-17
15.4.3	Geotechnical Recommendations for Pavement and Subgrade .....	15-20

15.4.4	Lump Sum Grading .....	15-22
15.4.5	Guardrail .....	15-23
15.4.6	Cable Guiderail.....	15-29
15.4.7	Fencing .....	15-29
15.4.8	Drainage.....	15-31
15.4.9	Pavement.....	15-31
15.4.10	Structures.....	15-32
15.4.11	Roadside Environmental .....	15-32
15.5	Cost-Based Estimate .....	15-33
15.6	AASHTOWare Project and the Pay Items and Quantities Tool.....	15-33
<b>Chapter 16 Roadway Lighting and Electrical .....</b>		<b>16-1</b>
16.1	Introduction .....	16-1
16.1.1	Lighting Overview.....	16-1
16.1.2	References.....	16-1
16.2	Lighting Policy.....	16-1
16.2.1	Roadway Lighting Committee.....	16-1
16.3	Lighting Evaluations.....	16-1
16.3.1	Full Control of Access Freeways and Interchanges .....	16-2
16.3.2	Partial, Limited and No Control of Access Roadways and Intersections .....	16-2
16.4	Illumination Requirements.....	16-2
16.4.1	Continuous Freeway Lighting .....	16-3
16.4.2	Complete Interchange Lighting.....	16-3
16.4.3	Rest Areas .....	16-3
16.4.4	Weigh Stations .....	16-3
16.4.5	Vehicular Tunnels.....	16-3
16.4.6	Limited, Partial and No Control of Access Facilities .....	16-4
16.4.7	Roundabouts.....	16-4
16.4.8	Pedestrian Underpasses, Culverts and Tunnels .....	16-4
16.5	Design Criteria .....	16-4
16.5.1	Lighting Layout Guidelines .....	16-5
16.5.2	Voltage Drop Requirements .....	16-5
16.5.3	Equipment Locations .....	16-5
16.5.4	Photometric Designs .....	16-6
16.5.5	Limited, Partial and No Control of Access Facilities .....	16-7
16.6	Design-Build Guidelines.....	16-7
16.6.1	Scope of Work and Preliminary Lighting Plans .....	16-7
16.6.2	Final Lighting Plans .....	16-8
16.7	Power Supply.....	16-8
16.8	Bid Items and Estimates .....	16-8
16.8.1	Design-Bid-Build Projects.....	16-9
16.8.2	Design-Build Projects .....	16-9
16.9	Special Considerations .....	16-9
16.9.1	Coordination with the Federal Aviation Authority .....	16-9
16.9.2	Wildlife Sensitive Areas .....	16-10
16.10	Specifications.....	16-10
16.10.1	Standard Specifications.....	16-10
16.10.2	Standard Provisions .....	16-11
16.10.3	Project Special Provisions .....	16-11
16.10.4	Additional Resources.....	16-11

<b>Chapter 17 Design Exception Preparation Guidelines</b> .....	<b>17-1</b>
17.1 Design Exception Process .....	17-1
17.2 Design Policy .....	17-1
17.3 Design Flexibility .....	17-1
17.4 Need for a Design Exception .....	17-2
17.4.1 Design Exception Definition.....	17-2
17.4.2 Design Exception Approval Authority.....	17-3
17.4.3 Design Exception Submittal Timeframe.....	17-3
17.4.4 Revisions to Approved Design Exception.....	17-3
17.4.5 Retention of Design Exceptions.....	17-3
17.5 Controlling Criteria for Design .....	17-4
17.5.1 Design Speed.....	17-4
17.5.2 Lane Width.....	17-4
17.5.3 Shoulder Width.....	17-5
17.5.4 Horizontal Curve Radius.....	17-5
17.5.5 Superelevation Rate.....	17-5
17.5.6 Stopping Sight Distance .....	17-5
17.5.7 Maximum Grade.....	17-5
17.5.8 Cross Slope.....	17-5
17.5.9 Vertical Clearance .....	17-5
17.5.10 Design Loading Structural Capacity.....	17-5
17.6 Complete the Design Exception Process Checklist.....	17-6
17.7 Complete the Design Exception Request Form.....	17-10
17.7.1 Heading Section.....	17-10
17.7.2 Project Data Section.....	17-10
17.7.3 Basis for Exception.....	17-11
17.7.4 Design Exception Request Submittal.....	17-12
17.8 Example Forms.....	17-15
17.8.1 NCDOT Design Exception Request – Example 1 .....	17-15
17.8.2 NCDOT Design Exception Checklist – Example 1 .....	17-21
17.8.3 NCDOT Design Exception Request SRT – Example 2 .....	17-23
17.8.4 NCDOT Design Exception Checklist SRT – Example 2 .....	17-27
17.8.5 NCDOT Design Exception Request Design Speed – Example 3 .....	17-29
17.8.6 NCDOT Design Exception Checklist Design Speed – Example 3.....	17-32

## Tables-Part I

Table 2-1 Pedestrian Group Characteristics and Behaviors .....	2-12
Table 2-2 Required Number of Lanes for Detour.....	2-21
Table 3-1 Stopping Sight Distance on Grades .....	3-2
Table 3-2 Minimum Width of Traveled Way and Usable Shoulder for Rural Arterials .....	3-5
Table 3-3 Minimum Width of Traveled Way and Shoulders for Collector Roads.....	3-6
Table 3-4 Minimum Width of Traveled Way and Shoulders for Two-Lane and Local Roads in Rural Areas .....	3-7
Table 3-5 Superelevation Guidelines .....	3-8
Table 4-1 Normal Shoulder Widths for Locals and Collectors.....	4-3
Table 4-2 Normal Shoulder Widths for Arterials, Interstates, and Freeways.....	4-3
Table 4-3 Median Shoulder Widths .....	4-4
Table 4-4 NCDOT Paved Shoulder Guidance .....	4-5
Table 4-5 Suggested Clear-Zone Distances from Edge of Through Traveled Lane.....	4-14
Table 4-6 Median Widths for Highways other than Freeways.....	4-20
Table 4-7 Recommended Maximum Median Slopes .....	4-21
Table 4-8 Desirable and Minimum Sidewalk and Berm Widths .....	4-31
Table 5-1 Minimum Clear Roadway Width and Vertical Clearances for Existing Bridges to Remain in Place .....	5-2
Table 5-2 Clear Bridge Deck Widths for SRTG Projects.....	5-4
Table 5-3 Vertical Clearances for Highway Bridges .....	5-43
Table 5-4 Standard Design Cored Slab and Box Beams Parameters.....	5-48
Table 5-5 Typical Usage of Standard Bridge Approach Fill Details.....	5-67
Table 6-1 Barrier Guidelines for Non-Traversable Terrain and Roadside Obstacles .....	6-3
Table 6-2 Standard Median Concrete Barrier Types .....	6-14
Table 6-3 Typical Barrier Placement for Various Median Widths.....	6-15
Table 8-1 Design Widths and Modifications for Edge Conditions of the Traveled Way for Turning Roadways .....	8-16
Table 9-1 Guide Values for Ramp Design Speed as Related to Highway Design Speed .....	9-8
Table 9-2 Desirable Curvature for Ramps in the Vicinity of the Gore Area .....	9-10
Table 9-3 Vertical Sight Distance Control for Crest Curves at Interchanges, Single Unit Vehicle Criteria .....	9-19
Table 9-4 “c” Distance Required from End of Bridge to Ramp Terminal .....	9-20
Table 9-5 Recommended Minimum Ramp Terminal Spacing.....	9-27
Table 10-1 Reaction Time and Distances for Functional Area of Intersections .....	10-2

## Tables Part II

Table 12-1 Labeling Precision Preferences for Typical Sections .....	12-1
Table 12-2 Labeling Precision Preferences for Plans.....	12-2
Table 12-3 Labeling Precision Preferences for Profiles .....	12-2
Table 12-4 Labeling Precision Preferences for Cross Sections .....	12-3
Table 13-1 Final Plan Sheet Arrangement Index of Sheets .....	13-8
Table 13-2 Code Letters for Pavement Schedule.....	13-12
Table 13-3 Minimum and Maximum Pavement Thickness .....	13-15
Table 13-4 Properties of Asphalt Mix Types.....	13-16
Table 13-5 Permitted Construction Type .....	13-31
Table 13-6 Standard Roadway Design Alignment Naming Convention .....	13-49
Table 13-7 Sheet Breakdown for Submittal Types .....	13-51
Table 13-8 Plan Sheet Submittal Acronyms .....	13-51

Table 13-9 Final Plans File Name Breakdown.....	13-51
Table 15-1 Master Pay Items List Information .....	15-4
Table 15-2 Guardrail Anchor Deductions .....	15-26
Table 16-1 Counties with Listed Bat Species .....	16-10
Table 16-2 Additional Resources .....	16-11

## Figures-Part I

Figure 2-1 Bicyclist Design User Profiles.....	2-13
Figure 2-2 Fully Separated Bikeways.....	2-14
Figure 2-3 Pavement Edge Construction with Flexible Pavement .....	2-17
Figure 2-4 Pavement Edge Construction with Shoulder Drains .....	2-18
Figure 4-1 Normal and Total Shoulder Width for Locals and Collectors .....	4-3
Figure 4-2 Normal and Total Shoulder Width for Arterials, Interstates, and Freeways.....	4-4
Figure 4-3 Typical Shoulder Cross Slopes .....	4-7
Figure 4-4 Criteria for Roadway Typical Section and Slopes.....	4-9
Figure 4-5 Detail Guide for Vehicle Recovery Areas .....	4-16
Figure 4-6 Berm Width.....	4-18
Figure 4-7 Grading of Spread Median .....	4-26
Figure 4-8 Commercial and Residential Driveway Profile.....	4-29
Figure 5-1 Interstate System Bridge Deck Widths for Four or More Lanes Divided Shoulder Approach .....	5-10
Figure 5-2 Freeway System Bridge Deck Widths for Four or More Lanes Divided Shoulder Approach .....	5-11
Figure 5-3 Arterial System Bridge Deck Widths for Two-Lane Two-Way Traffic .....	5-12
Figure 5-4 Arterial System Bridge Deck Widths for Four or More Lanes Divided Shoulder Approach and Curb and Gutter Approach .....	5-13
Figure 5-5 Arterial System Bridge Deck Widths for Four or More Lanes Divided Shoulder Approach and Curb and Gutter Approach with Auxiliary Lanes .....	5-14
Figure 5-6 Arterial System Bridge Deck Widths for Four or More Lanes Undivided.....	5-15
Figure 5-7 Collector Roads and Streets Bridge Deck Widths for Two-Lane Two-Way Traffic .....	5-16
Figure 5-8 Local Roads and Streets Bridge Deck Widths.....	5-17
Figure 5-9 Local and Collector System Bridge Deck Widths for Four or More Lanes Divided .....	5-18
Figure 5-10 Local and Collector System Bridge Deck Widths for Four or More Lanes Divided with Auxiliary Lanes .....	5-19
Figure 5-11 Local and Collector System Bridge Deck Widths for Four or More Lanes Undivided Two-Way Traffic.....	5-20
Figure 5-12 One Way Ramp Bridge Deck Widths .....	5-21
Figure 5-13 Interstate or Freeway System Horizontal Clearances for Divided Traffic-.....	5-24
Figure 5-14 Arterial System Horizontal Clearances for Undivided Traffic .....	5-28
Figure 5-15 Arterial System Horizontal Clearances for Divided Traffic Shoulder Approach ...	5-31
Figure 5-16 Arterial System Horizontal Clearances for Divided Traffic Curb and Gutter Approach .....	5-34
Figure 5-17 Local and Collector System Horizontal Clearances for Design Year ADT .....	5-37
Figure 5-18 One Way Ramp Horizontal Clearances.....	5-40
Figure 5-19 Minimum offset between Permanent and Detour Bridges.....	5-49
Figure 5-20 Shoulder Detail Under Bridge with Bridge Pier and Concrete Barrier or with End Bent Slope and Guardrail .....	5-54
Figure 5-21 Shoulder Detail Under Bridge with 6-Inch Slope Protection or Abutment Wall....	5-59
Figure 5-22 Berm Detail Under Bridge .....	5-61
Figure 5-23 Standard Method of Shoulder Construction Under Bridges .....	5-64

Figure 5-24 Paved Shoulder Taper at Bridges .....	5-66
Figure 5-25 Typical Retaining Wall Section.....	5-72
Figure 5-26 Example Retaining Wall Envelope Drawing .....	5-76
Figure 5-27 Offsets for Steel Beam Guardrail at Retaining Walls .....	5-78
Figure 5-28 Concrete Barrier Rail with Moment Slab on Retaining Wall .....	5-79
Figure 6-1 Detail of Guardrail Placement on Approach End of Rigid Obstacle Warrant.....	6-5
Figure 6-2 Detail of Guardrail Placement on Trailing End of Rigid Obstacle Warrant .....	6-6
Figure 6-3 Detail of Guardrail Placement on Approach and Trailing End of Fill Slope Warrant	6-8
Figure 6-4 Detail of Guardrail Placement on Approach End of Hazard Located on Horizontal Curve .....	6-9
Figure 6-5 Special Grading in Superelevated Location.....	6-18
Figure 7-1 Minimum Pipe Cover Requirements.....	7-3
Figure 7-2 Minimum Box Culvert Cover Requirements.....	7-3
Figure 7-3 Skew Angle Designations .....	7-4
Figure 7-4 Clear Roadside Recovery Area for Access Roads .....	7-8
Figure 7-5 Example of Endwall Treatment .....	7-9
Figure 8-1 Typical Single Lane Roundabout .....	8-3
Figure 8-2 Reduced Conflict Intersection .....	8-5
Figure 8-3a Reduced Conflict Intersection – Inset “A” Raised Median Section .....	8-6
Figure 8-3b Reduced Conflict Intersection – Inset “A” Shoulder Section .....	8-7
Figure 8-4 Reduced Conflict Intersection – Inset “B” .....	8-8
Figure 8-5 Desirable Intersection Skews.....	8-9
Figure 8-6 Profile Rollover at Intersections.....	8-11
Figure 8-7 Intersection Sight Distance .....	8-12
Figure 8-8 WB-62 and WB-62FL Truck Dimensions.....	8-13
Figure 8-9 Right Turn Lane Warrants.....	8-20
Figure 8-10 Turn Lanes.....	8-21
Figure 8-11 Recommended Treatment for Turn Lanes.....	8-23
Figure 8-12 Guidelines for Offsetting Opposing Left Turn Lanes on Divided Roadways with a 23’ Median .....	8-26
Figure 8-13 Guidelines for Offsetting Opposing Left Turn Lanes on Divided Roadways with a 30’ Median .....	8-27
Figure 8-14 Guidelines for Offsetting Opposing Left Turn Lanes on Divided Roadways with a 36’ Median .....	8-28
Figure 8-15 Guidelines for Offsetting Opposing Left Turn Lanes on Divided Roadways with a 46’ Median .....	8-29
Figure 8-16 Roundabout Typical Section .....	8-31
Figure 9-1 Interchange Quadrant Letter Designation .....	9-6
Figure 9-2 Ramp Gore Grade Control Points .....	9-14
Figure 9-3 Maximum Grade Control Points in Gore Area .....	9-17
Figure 9-4 Vertical Sight Distance Control for Crest Curves at Interchanges, Single Unit Vehicle Criteria .....	9-19
Figure 9-5 Design Requirements for Crossroad Sight Distance at Interchanges, Single Unit Vehicle Criteria.....	9-20
Figure 9-6 -Y- Line Transition at Ramp Terminal for Three-Lane -Y- Line Section .....	9-22
Figure 9-7 Ramp Terminal Design .....	9-23
Figure 9-8 Plan for Loop Ramp Terminal Combination.....	9-24
Figure 9-9 Section View for Loop Ramp Terminal Combination .....	9-25
Figure 9-10 Acceptable Ramp Terminal Skews.....	9-26
Figure 10-1 Functional Area of an Intersection.....	10-3
Figure 10-2 Intersection Turn Radii.....	10-4

Figure 10-3 Three Lanes at Major Drives ..... 10-5  
Figure 10-4 Example Driveway Scenario for Corner Business ..... 10-7  
Figure 10-5 Angled Driveways on One-Way Streets ..... 10-8  
Figure 10-6 Driveway with Controlled or Restricted Entry ..... 10-9



## Figures Part II

Figure 13-1 Crown Point and Grade Point on a Typical Section.....	13-11
Figure 13-2 False Cut in Draw Between Cut Slopes .....	13-19
Figure 13-3 False Cut to be Used on Waste Projects Where Fill Height Exceeds 30" .....	13-19
Figure 13-4 Alternate Base Course Material Earthwork sample .....	13-24
Figure 13-5 Pavement Alternate Base Course Material typical.....	13-25
Figure 13-6 Example for Computing Quantity of Masonry Drainage Structure .....	13-30
Figure 14-1 Existing Right of Way Line and Monuments .....	14-6
Figure 14-2 Proposed Right of Way Line and Monuments .....	14-7
Figure 14-3 Control of Access.....	14-7
Figure 14-4 Control of Access with C/A Monument.....	14-7
Figure 14-5 Temporary and Permanent Easement Lines .....	14-9
Figure 14-6 Permanent Easement Monuments.....	14-10
Figure 14-7 Guide for Fence Locations at -Y- Line over Freeway .....	14-11
Figure 14-8 Guide for Fence Locations at Freeway over -Y- Line .....	14-11
Figure 15-1 Shrinkage Factors.....	15-12
Figure 15-2 Blank Earthwork Balance Sheet.....	15-13
Figure 15-3 Borrow Project Example.....	15-14
Figure 15-4 Waste Project Example.....	15-15
Figure 15-5 Sample Bid Item Schedule.....	15-23
Figure 15-6 Guardrail Summary Examples .....	15-27



## Acronyms and Abbreviations

Term	Description
AADT	annual average daily traffic
AASHTO	American Association of State Highway and Transportation Officials
ABC	aggregate base course
ADA	Americans with Disabilities Act
ADT	average daily traffic
ADTT	average daily truck traffic
ANSI	American National Standards Institute
ATLAS	Advancing Transportation Through Linkages, Automation, and Screening
AUE	aerial utility easements
<u>AWP</u>	<u>AASHTOWare project</u>
BOS	bus on shoulder
CA	control of access
CADD	computer-aided design and drafting
CAMA	Coastal Area Management Act
CDR	collector distributor
CONST	construction
<u>CFI</u>	<u>continuous flow intersection</u>
<u>CMF</u>	<u>crash modification factor</u>
CR	curb cuts and ramp
<u>CRF</u>	<u>crash reduction factor</u>
CS	curve to spiral
CSX	CSX transportation supplier
D	peak hour directional split
DDHV	directional design hour volume
DDI	diverging diamond interchanges
DHV	design hourly volume
DMS	<u>degrees, minutes, seconds</u> <del>dynamic message sign</del>
<u>DNR</u>	<u>design noise report</u>
DOT	Department of Transportation
DRPS	design recommendation plan set
DUAL	trucks with at least one dual tired axle
DUE	drainage/utility easement
EAU	environmental analysis unit
EN	entrance
EX	exit
FA	Federal Highway Administration Project Number
FAA	Federal Aviation Authority
FAHP	Federal-Aid Highway Program
FAST	freeway and street-based transit
FB	frontage boundary line

Term	Description
FDOT	Florida Department of Transportation
FDR	freeway distributor
FEMA	Federal Emergency Management Agency
FHWA	Federal Highway Administration
FRE	free range eagle interchange
FT	feet
FWY	freeway
GB	AASHTO Green Book ( <i>A Policy on Geometric Design of Highways and Streets</i> (2018), 7th Edition)
GDOT	Georgia Department of Transportation
GIS	geographic information system
GREU	guardrail end unit
GSRS	grade severity rating system
H:V	Horizontal to vertical
HCM	Highway Capacity Manual (Transportation Research Board)
HP	h-piles
HTCG	high tension cable guiderail
<a href="#">IAR</a>	<a href="#">interstate access report</a>
ICD	inscribe circle diameter
IEEE	Institute of Electrical and Electronics Engineers
IES	Illuminating Engineering Society
IN	inches
IPD	Integrated Project Delivery
ITS	Intelligent Transportation Systems
K	rate of vertical curvature
KW	kilowatt
L	rate of vertical curvature
L <sub>A</sub>	lateral extent of the area of concern
LADA	location and design approval
L <sub>C</sub>	clear zone
LED	light-emitting diode
LET	Advertising projects to be bid on by qualified contractors to construct the project
LF	linear foot
LiDAR	light detection and ranging or laser imaging, detection, and ranging
LON	length of need
L <sub>R</sub>	runout length
L <sub>S</sub>	location and design approval
LS	total length of spiral
LT	long tangent
LTCCG	low tension cable guiderail
MASH	manual for assessing safety hardware

Term	Description
<u>MOT</u>	<u>maintenance of traffic</u>
MPH	miles per hour
MSE	mechanically stabilized earth
MUT	median U-turn
MUTCD	FHWA Manual on Uniform Traffic Control Devices
NACTO	National Association of City Transportation Officials
NC	North Carolina
NCAC	North Carolina Administrative Code
NCDOT	North Carolina Department of Transportation
NCFMP	North Carolina Floodplain Mapping Program
NCHRP	National Cooperative Highway Research Program
NCID	North Carolina ID (ncid.NC.Gov)
NCRR	North Carolina Railroad
NEC	National Electrical Code
NEPA	National Environmental Policy Act
NESC	National Electrical Safety Code
NFPA	National Fire Protection Association
NHS	National Highway System
NRTR	Natural Resource Technical Report
OGAFC	open graded asphalt friction course
PC	point of curvature
PCC	point of compound curve
PDE	permanent drainage easement
PDF	adobe format
PDN	project delivery network
PE	preliminary engineering
PHV	peak hour volume
PI	priority index
PIQ	pay item quantities
PM	pendant mount
PROWAG	<del>(Proposed)</del> Public Right of Way Accessibility Guidelines
PS&E	plans, specifications, and estimates
PSP	project special provisions
PT	point of tangency
PUE	permanent utility easement
PVI	point of vertical intersection
QA	quality assurance
QC	quality control
QMS	quality management system
R	radius
RDG	AASHTO Roadside Design Guide
RDM	Roadway Design Manual

Term	Description
RDY	roadway design
RF	reforestation plans
RFP	request for proposals
RO	runoff
<u>ROD</u>	<u>Record of Decision</u>
ROW	right of way
RP	recommended practice
RSAP	Roadside Safety <u>Analysis</u> <del>Assistance</del> Program
RT	right
RW	right of way
SAPW	stand-alone project worksheet
SBW	sound barrier wall
SC	spiral to curve
SCB	soil cement base
SE	superelevation
SEPA	State Environmental Policy Act
SOIIA	Selecting Optimum Intersection or Interchange Alternatives
SP	special provision
SPDI	single point diamond interchange
SPOT	Strategic Prioritization Office
SPII	single point urban interchange
SR	secondary roads
SRTG	Subregional Tier Guidelines
SSD	stopping sight distance
ST	spiral to tangent
STC	strategic transportation corridors
STIP	State Transportation Improvement Program
SU	Single unit truck
SY	square yard
T	tangent distance
TDE	temporary drainage easement
TDP	total design process
TEPPL	traffic engineering policies, practices and legal authority
TER	truck escape ramp
TIP	transportation improvement program
TL	test level
TMP	transportation management plan
TRB	Transportation Research Board
TS	tangent to spiral
TTST	truck, tractor and semi-trailer
TUE	temporary utility easement
US	United States

<b>Term</b>	<b>Description</b>
<u>USFWS</u>	<u>US fish and wildfire service</u>
UTIL	utility
VC	vertical curve (length)
VMO	value management office
WBS	work breakdown structure
WM	wall mount
WZTC	work zone traffic control



**North Carolina Department of Transportation  
Roadway Design Unit**

**Roadway Design Manual  
Part I General Design Information**

This page intentionally left blank.

# Part I Overview

Part I of this Roadway Design Manual (RDM) is primarily directed to the design specific elements and information required to prepare a detailed roadway design. The outline and chapter content has been updated to closely follow the current version of the AASHTO Policy on Street and Highway Design while also providing NCDOT preferences.

This manual is also intended to provide the designer with flexibility in the design process while still maintaining reasonable conformity to common NCDOT design practices. The guidance in this manual is provided in narrative form, with charts, tables, and figures. Because all the design concepts presented cannot be covered exhaustively, references to additional literature will be provided for additional guidance. References to other North Carolina Department of Transportation (NCDOT or the Department) policies or other publications are made for any design criteria not included in this manual in narrative or chart format. ~~No references will be made to design practices believed to be common knowledge by well informed and experienced roadway designers.~~ Some commonly known design practices may not be addressed directly in this document. Designers should follow up with NCDOT Roadway Design Unit for clarification on the guidance. Designers should follow up with NCDOT Roadway Design Unit for clarification on the guidance. Due to the evolving nature of the Department's design and plan preparation processes, this document is considered a living document that will be continually edited and updated. If you notice incorrect or outdated information, or broken web links, please contact [NCDOT-RDM@ncdot.gov](mailto:NCDOT-RDM@ncdot.gov).



This page intentionally left blank.

# Chapter 1 Framework for Geometric Design

## 1.1 Introduction

The adoption of American Association of State Highway and Transportation Officials (AASHTO) *A Policy on Geometric Design of Highways and Streets* (2018), 7th Edition, commonly referred to as the Green Book (GB), will supersede all of the previous AASHTO policies and guides dealing with the geometric design of new construction and reconstruction projects. *A Policy on Design Standards - Interstate System* (2016) by AASHTO is also approved. These publications serve as the guiding documents for the development of the NCDOT Roadway Design Manual (RDM). The RDM serves to provide direction where NCDOT has a specific preference, requirement, or has determined additional guidance is warranted.

It is the responsibility of the NCDOT Project Manager and the roadway design engineer(s) to assure that all plans, specifications, and estimates (PS&Es) for federal aid and state funded projects conform to the design criteria in the current version of the GB and the RDM to the greatest extent possible. Exceptions to design criteria can be considered but must follow a design exception process as described in RDM Part II Chapter 17.

In addition to these guidelines, it is inherent in the process that the roadway designer use their best engineering judgement when designing a project. Each project contains unique elements specific to that project and designers are encouraged to avoid a one size fits all approach. Documentation of design decisions is expected. The design decision documentation should be maintained by the Roadway Engineer of Record throughout the duration of the project development on ProjectWise. See section 13.10.1 for more information. The designer is also encouraged to collaborate with other professionals throughout the process to provide the best possible design.

## 1.2 Overview of the Roadway Design Manual

The RDM establishes NCDOT roadway design criteria and supplements the current editions of AASHTO and other publications, by reference.

The information in this RDM has been written to follow the GB to the greatest extent possible. Sections in this RDM include NCDOT specific guidance with direct references to the GB and other documents, as appropriate.

This document includes an updated focus on Complete Streets and multimodal transportation design. The current focus is for the designer to incorporate a balanced approach to the needs of automobiles, bicyclists, pedestrians, transit, and trucks for each project.

## 1.3 Multimodal Considerations

Multimodal considerations are an essential element in the design of every road and street project. Design road and street facilities to accommodate current and anticipated users.

Transportation modes for road and street users generally fit into five categories:

1. Automobiles
2. Bicyclists
3. Pedestrians
4. Transit

## 5. Trucks

Refer to GB Chapter 1 Section 1.6 for a detailed discussion of each of the transportation mode categories listed above. Consider each mode in the design of every road and street project. The goal should be a context-based design that serves multiple transportation modes, as appropriate. Not every facility will be designed for every mode, but the decision should be arrived at after thorough consideration of the needs of each mode, local and regional transportation agency master plans, and community needs. Consider the following key factors when determining the appropriate facilities to provide for each road or street:

- Functional classification and context of the road or street
- Expected demand for each transportation mode (both current and anticipated)
- Area wide or corridor plans established by the community
- Assessment of demand for and needs of motor vehicle, pedestrian and bicyclist user types

The stated purpose and need for the street or road project will provide perspective on how best to support access and safety for all roadway users. Obtaining community and stakeholder input can help achieve an appropriate understanding. Look more broadly than a single project and consider the entire transportation network, keeping in mind the need for connectivity and for serving all users appropriately.

Refer to GB Chapter 1 Section 1.6 for information regarding considerations of all transportation modes.

Refer to [NCHRP Report 1036 - Roadway Cross Section Reallocation: A Guide](#) as an additional resource to understand tradeoffs associated with the cross section elements and how they impact each mode of transportation.

## 1.4 Design Process to Address Specific Project Types

The GB has developed a revised design process that varies by purpose and need as discussed in GB Chapter 1 Section 1.7. AASHTO has included this section for the first time in the 7th edition of the GB, and it is being implemented on a preliminary basis. This section will be refined for full implementation in upcoming editions of the GB.

The revised design process considers three types of projects:

1. New construction – roads in new corridors
2. Reconstruction – projects in existing corridors that change the basic roadway type
3. Construction on existing roads – projects in existing corridors that maintain the basic roadway type

Definitions of these terms have changed from previous versions of the GB and are presented in the following sections. Some projects may involve a mix of new construction, reconstruction, and construction on existing roads that may use different design approaches from those found in the GB and the sections below.

## 1.5 Purpose and Need

In partnership with stakeholders, if appropriate, the project team should develop an explicit purpose and need statement that indicates why each road or street improvement project is being undertaken and what each project intends to accomplish. This statement may be in the

form of the purpose and need statement used in National Environmental Policy Act (NEPA) analyses, a formal statement of objectives for the project, or a combination of the two approaches.

The purpose and need statement should achieve the following:

- Identify priorities for what will and will not be undertaken in the project and clearly identify any limitations.
- Address the project context and consider how each transportation mode should be handled.
- Indicate what aspects of performance will be improved and, in some cases, set targets for how much improvement is desired.
- Enable the designer to focus on addressing needs of a project without needlessly exceeding them, which allows more resources to be spent addressing needs elsewhere.

The scope of projects, based on their purpose and need, may range from minor projects on existing roads to new construction projects. Minor projects on existing roads addressing only one issue should focus on addressing the performance issue(s) that prompted the project, as well as other known performance issues identified in the project's purpose and need statement. Known performance issues may include congestion, safety, poor surface conditions or existing pavement failure.

For construction of roads on new alignments and those that change the basic road type, use the design criteria in the RDM Part I Chapters 2 through 10 while seeking the appropriate balance between transportation modes and other factors identified in the purpose and need statement.

Performance issues identified by the purpose and need statement.

- May address any of the factors listed in the GB Chapter 1 Section 1.1 but need not address them all.
- Are often identified from existing agency databases or field data.
- May be documented with models that can also be used to quantify the effectiveness of design improvements.
- Should not be based solely on noncompliance with geometric design criteria alone. If there are nonconforming geometric aspects of a road, but the road is performing satisfactorily, there may not be a need to address these geometric aspects with the project.
- May be measured quantitatively or qualitatively.

Refer to GB Chapter 1 Section 1.2 for additional information regarding project purpose and need.

### 1.5.1 New Construction

New construction projects consist of new roads on new alignments or corridors. These new construction projects are typically able to meet the design criteria set forth in RDM Part I Chapters 2 through 10.

To assist the designer in finding an appropriate balance among all transportation modes, utilize performance measures during the design process for new construction projects. These

performance measures will identify situations in which departing from specific design criteria may have specific benefits with minimal impacts to the overall performance of the completed project.

Refer to GB Chapter 1 Section 1.7.1 for detailed information.

## 1.5.2 Reconstruction Projects

Reconstruction projects include those that use an existing roadway alignment or corridor (or make only minor changes to an existing alignment), but involve a change in the basic road type including widening to add through lanes, adding a median where none currently exists, or extending changes beyond the existing roadway width (including shoulders). These types of projects can be challenging due to the constraints encountered on existing alignment corridors. Applying all the design criteria in the RDM Part I Chapters 2 through 10 is desirable but may not always be practical. Design decisions should be made based on priorities established by the purpose and need of the project and utilization of a performance-based approach.

Refer to GB Chapter 1 Section 1.7.2 for more information about this type of project.

## 1.5.3 Existing Roadway Construction

Construction projects on existing roadways keep the existing alignment and do not change the basic road type. Such projects typically consist of resurfacing, restoration, and rehabilitation (R-R-R), plus other improvements for which there is a specific identified need. However, the definition of projects on existing roads is more expansive than R-R-R work. It includes projects where current or anticipated traffic operational congestion does not meet targeted LOS based on the Transportation Research Board's (TRB) *Highway Capacity Manual 6th Edition: A Guide for Multimodal Mobility Analysis* (HCM) or where current or anticipated crash patterns can be addressed by the AASHTO *Highway Safety Manual* or other tools that can address the concern. The existing geometric design of the facility may be retained where it is deemed to be performing well by validated analytical tools.

The GB encourages greater flexibility in design for all projects, but particularly projects on existing roads. In the case of existing roadway construction, the design is oriented toward addressing identified performance issues, roadway context, and community and multimodal needs, rather than improving geometric design features simply because they do not meet current criteria applicable to new construction. Flexibility in design allows limited agency resources to be applied more effectively to identified problems on multiple roadway projects.

Currently, NCDOT utilizes the [NCDOT Guide for Resurfacing, Restoration, and Rehabilitation \(R-R-R\) of Highways and Streets](#) to establish design criteria for R-R-R projects. NCDOT is in the process of updating the guide to reflect NCHRP Report 876 which employs a cost-effectiveness approach to decision making for corridor improvements.

Refer to RDM Part I Chapter 10 Section 10.3 for more information about R-R-R guidance and GB Chapter 1 Section 1.7.3 for additional information about existing roadway construction.

## 1.6 Project Cost Reduction Guidelines

NCDOT's primary objective for highway design is to create safe, functional, aesthetically appealing facilities adequate for the design traffic demands at minimum life cycle costs. The following guidelines suggest possible design changes to help reduce project costs. Evaluate the suitability of each suggested change within the context of the primary objective of highway design. Coordinate decisions with the project team including Division and other internal and external stakeholders throughout the project life.

### 1.6.1 Avoid Overdesign

Consider using minimum design criteria, where doing so will not significantly compromise safety or function while still meeting the purpose and need of the project.

### 1.6.2 Cross Section

- Median width – Use the minimum width compatible with the type of facility, the needs of projected traffic, positive drainage requirements, and median crossover design.
- Lane width – Refer to GB Chapter 5 Section 5.2 Table 5-5; Chapter 6 Section 6.2 Table 6-5; and Chapter 7 Section 7.2 Table 7-3 for desirable lane widths for local roads, collector roads, and arterial roads, respectively.
  - Refer to RDM Part I Chapter 4 Section 4.3 for additional information. Less than desirable lane widths may remain for construction on existing roadways where alignment and safety records are satisfactory.
- Shoulder width – Refer to RDM Part I Chapter 4 Section 4.4 for minimum shoulder widths. A design exception is required for shoulder widths that do not meet the controlling criteria.
- Roadway ditch – Refer to RDM Part I Chapter 4 Section 4.8 for standard methods of designing roadway ditches. Flatter or steeper slopes may be warranted by project specific- soil conditions, accident history, or requirements for balancing earthwork.
- Ramp widths – The standard ramp pavement width is 16 feet; however, 12-foot ramp pavement width may be used if the full usable width of the right shoulder is to be paved. Refer to RDM Part I Chapter 9 Section 9.4.
- -Y- lines – Select -Y- line pavement width and intersection radii appropriate for -Y- line traffic volumes and characteristics and compatible with the existing -Y- line cross section.
- Additional multimodal elements – Include separated transportation facilities, such as sidewalks, bus stops, and shared use paths, as these elements are required by the [NCDOT Complete Streets Policy](#). Refer to RDM Part I Chapter 4 Sections 4.14 through 4.17.

### 1.6.3 Earthwork

- Earthwork is one of the highest-cost items on projects; therefore, make every effort to reduce and balance earthwork.
- Use the steepest slopes practical while considering soil conditions, safety requirements, constructability, and maintenance.
- To help reduce earthwork, give careful attention to the selection of horizontal and vertical alignments. Attempt to balance cut-and-fill sections and avoid areas with poor soil conditions. Review project alignments carefully with the NCDOT Project Manager.
- Use waste to flatten slopes and build false cuts to improve safety, eliminate guardrail, and eliminate the need for waste pits. (Where possible, use unsuitable material to flatten slopes.)
- Use cost-effective analysis to determine if it is more economical to flatten slopes or use guardrail. (Consider right of way cost and cost of providing waste areas.)

- Preliminary grades usually are based on LiDAR information downloaded from North Carolina's SPATIAL Data Download website <https://sdd.nc.gov>. When beginning Alignment Defined (Stage 2) plans, as defined in the [NCDOT Project Delivery Network \(PDN\)](#), review and refine the preliminary grades using final surveys so they will be accurate and cost effective.

#### 1.6.4 Right of Way

- Where feasible, use temporary easements rather than purchasing property. This reduces right of way costs and the unnecessary taking of property. Refer to RDM Part II Chapter 14.
- Consider using an "L" or "Tee" type turnaround instead of a circular cul-de-sac to save pavement cost and reduce right of way on roads being dead-ended.
- Consider reducing commercial channelization to that required for sight distance and maintenance of roadway.

#### 1.6.5 Drainage

- Review drainage and have the hydraulics designer recheck whenever it appears changes could be made to reduce cost.
- In interchange areas, look closely at drainage to see if grading adjustments could simplify drainage and reduce drainage items.

#### 1.6.6 Pavement Design

Review the proposed pavement designs to determine if the design works for curb and gutter applications and if there are opportunities to minimize the total number of typical sections by combining similar designs.

#### 1.6.7 General

- Carefully review high-cost items such as bridges, culverts, barriers, walls, and special designs to reduce or eliminate where possible.
- Coordinate with the Utilities Unit to minimize impacts or avoid existing utilities where possible.
- Recheck the need for detour structures. If it is possible to close the road, coordinate with the hydraulics and structures engineers to determine if a precast box culvert can be used to allow closing a road for the minimum amount of time possible. Consider whether a portable detour structure can be used.
- Consult with the Value Management Office (VMO) and consider submitting a project for a Value Engineering Study if the construction cost exceeds \$20,000,000 and the design has not progressed past the right of way stage.



# Chapter 2 General Design Criteria

## 2.1 Design Policy Interpretation

The criteria related to design speed, lane and shoulder widths, bridge width, design loading structural capacity, horizontal and vertical alignment, grades, stopping sight distance, cross slopes, superelevation, and horizontal and vertical clearances contained or referenced in RDM Part I Chapter 3 Design Elements; Chapter 4 Cross Section Elements; and Chapter 5 Structures are controlling criteria and require formal design exceptions when not met. In the absence of material covering controlling criteria in those RDM chapters, set design criteria based on GB Chapters 3 and 4.

## 2.2 Selection of Design Criteria

Selection of the correct design criteria for a project is one of the most important responsibilities of the roadway designer. There is an unlimited variety of factors that can affect the design of a specific project, making it impossible to address every possibility here. However, design criteria are most strongly affected by functional classification, design speed, traffic volumes, character, composition of traffic, and type of right of way. Since these classifications are the major points of design that must be established, a brief explanation of each is provided in the following sections.

Typically, when full control of access is purchased, design standards are higher than when there is partial or no control. Control factors such as unusual land features, safety, and economics are highly reflected in the design criteria.

Refer to RDM Part I Chapter 4 Sections 4.14, 4.15, 4.16, and consider multimodal design when selecting design criteria.

The NCDOT Project Manager provides the scoping report for the roadway designer to establish most design criteria, but the designer may have adequate justification to revise some of this information as in-depth design studies are undertaken. Recognize that the design criteria provided by the NCDOT Project Manager outlines appropriate criteria for use in designing most roadway projects. It is the responsibility of the roadway designer to determine when deviations from the design criteria are necessary.

If the scoping report is not available, establish the design speed and minimum horizontal curvature through the following process:

- Define the facility type and functional classification
- Determine the appropriate posted speed based on the type of roadway classification and input from the Division or stakeholders
- The design speed ( $V_d$ ) is set 5 mph above the posted speed selected
- Designers should not use curb and gutter on facilities with a design speed over 50 mph. At design speeds greater than 50-mph, avoiding travel-lane spread on curb and gutter facilities is not practical due to the excessive number of inlets required and even a shallow depth of water on the pavement can cause hydroplaning.
- Use the Superelevation Guidelines Table, RDM Part I Chapter 3 Section 3.4 to establish the correct rate of maximum superelevation (SE) for the roadway classification



- The minimum horizontal radius ( $R_{min}$ ) will be determined using the SE tables for the selected maximum SE and  $V_d$ . Refer to GB Chapter 3 Section 3.3.5 Tables 3-8 through Table 3-12.

When the functional classification, design speed, traffic volumes, and terrain classification are chosen, the design criteria for the particular project can be established. Critical design elements not meeting AASHTO standards may require an approved design exception. These critical design elements are design speed, lane width, shoulder width, horizontal curve radius, superelevation rate, stopping sight distance, maximum grade, cross slope, vertical clearance, and design loading structural capacity.

Refer to RDM Part II Chapter 17 for additional guidance on design exceptions. NCDOT will continue to update RDM Part II Chapter 17 as the NCDOT Design Exception Policy is finalized.

The NCDOT Project Manager and Roadway Design Unit should coordinate with the Federal Highway Administration (FHWA) North Carolina Division for projects on the National Highway System. On all other projects, design exceptions will be approved by the NCDOT Technical Services Unit or the Division Engineer. Document any other significant design elements not meeting AASHTO standards in the project file. The [NCDOT Interstate Controlling Criteria Tool](#) has been developed to aid the designer in identifying the interstate controlling criteria values and potential design exceptions on interstate facilities.

NCDOT has developed a tool designed to improve business processes and provide a framework of data. Advancing Transportation through Linkages, Automation, and Screening (ATLAS) provides geographic information system (GIS) based data on a regional level improving business practices and supporting informed project delivery. As resources are made available to ATLAS, designers will have the ability to search and query information for use in establishing design criteria on projects.

## 2.2.1 Functional Classifications

Functional classifications of a roadway refer to the role a roadway serves in the transportation network. This includes formal classification of freeways, arterials, collectors, and local roads and streets. In addition to these classifications, NCDOT also uses the facilities of expressways, boulevards, and thoroughfares.

Refer to GB Chapter 1 Section 1.4 for detailed discussion and information about functional classifications for roadways and motor vehicles, including discussion of the interrelated hierarchy of motor vehicle movement and the relationship between providing mobility for through-traffic movements and providing access to trip origins and destinations.

Refer to [NCDOT Facility Type and Control of Access Definitions](#) for more information on NCDOT functional classifications.

Roadways at each level in the hierarchy of motor vehicle movement are classified separately for rural functional systems and urban functional systems due to the fundamentally different characteristics of urban and rural areas. In either setting, the functional systems contain hierarchical categories listed in increased to decreased levels of emphasis on the free flow of through traffic as follows:

- Freeway systems
- Principal or major arterial systems
- Minor arterial systems

- Collector systems
- Local systems

Minor arterials can utilize collector criteria if the existing conditions of the corridor have collector characteristics and if applying that criteria is in alignment with the project's needs and objectives. Determine the tradeoffs of selecting collector criteria over arterial criteria by examining the crash history, traffic data, and project footprint. If the collector criteria is selected, record the decision in the Design Decisions document.

Refer to NCDOT's Functional Classification Map on [GO!NC](#) when determining the functional classification of an NCDOT road.

### 2.2.1.1 Rural Areas

Per Section 101 of Title 23 U.S. Code, rural areas are defined as all areas of a state not included in an urban area. Despite the traditional classification of roadways as urban or rural based on their setting outside or within an urban boundary, it is important for the roadway designer to use the determination of the area type classification for design. This determination must be made based upon the prevailing conditions of the site and decided early in the roadway planning process in consultation with community and project reviewers.

Refer to GB Chapter 1 Section 1.4.3.3 for a detailed definition of rural areas.

#### Rural Principal Arterial System

The rural principal arterial system is a network of routes with the greatest level of emphasis on free flow of through traffic in a rural setting. The general arterial classification can include rural freeways and expressways which are a separate functional class and should be designed accordingly.

Refer to GB Chapter 1 Section 1.4.3.3.1 for more detail on the rural principal arterial system.

#### Rural Minor Arterial System

The rural minor arterial system is a network of routes that have relatively high travel speeds and minimal interference points.

Refer to GB Chapter 1 Section 1.4.3.3.2 for more detail on the rural minor arterial system.

#### Rural Collector System

The rural collector system is a group of routes that generally serve short distance trips and may stay within a county. These systems have moderate speeds and frequent access points. Major collector roads and minor collector roads are included in this classification.

Refer to GB Chapter 1 Section 1.4.3.3.3 for more detail on the rural collector system.

#### Rural Local System

The rural local road system primarily provides access to land adjacent to the roadway and serves travel over short distances.

Refer to GB Chapter 1 Section 1.4.3.3.4 for more detail on the rural local road system.

### 2.2.1.2 Urban Areas

Per Section 101 of Title 23 U.S. Code, urban areas are defined as those places within boundaries set by state and local officials which have a population of 5,000 or more. Subdivisions of urban areas include small urban areas (with populations ranging from 5,000 to 50,000) and urbanized areas (with populations of 50,000 or more).

Refer to GB Chapter 1 Section 1.4.3.4 for a detailed definition of urban areas.

#### Urban Principal Arterial System

The urban principal arterial system serves major centers of activity and has the highest traffic volume corridors and longest trip lengths. The majority of fully and partially controlled access facilities are usually part of this functional class.

Refer to GB Chapter 1 Section 1.4.3.4.1 for more detail on the urban principal arterial system.

#### Urban Minor Arterial System

The urban minor arterial system places more emphasis on land access, accommodation of multimodal travel, and connectivity. These street systems offer lower traffic mobility than a principal system and include all arterials that are not classified as principal.

Refer to GB Chapter 1 Section 1.4.3.4.2 for more detail on the urban minor arterial system.

#### Urban Collector System

The urban collector system provides both land access service and traffic circulation within neighborhoods, commercial, and industrial areas. These systems distribute trips within neighborhoods which arterials do not.

Refer to GB Chapter 1 Section 1.4.3.4.3 for more detail on the urban collector system.

#### Urban Local System

The urban local system allows direct access to abutting lands and has the lowest level of mobility, usually seeing frequent bicycle, pedestrian, and transit movements.

Refer to GB Chapter 1 Section 1.4.3.4.4 for more detail on the urban local road system.

## 2.2.2 Context Classifications

Context classifications are defined based on development density, land use, and building setbacks in addition to population size. These classifications help designers better serve community needs by finding an appropriate balance between different modes of transportation. Pedestrian, bicycle, and transit user activity responds to land use context and roadway conditions such as traffic volumes and speed. Consequently, the pedestrian, bicycle, and transit facilities selected for a project will depend heavily on context.

Refer to GB Chapter 1 Section 1.5 for more detail on context classifications.

### 2.2.2.1 Context Classes for Roads and Streets in Rural Areas

Design roads in rural areas for either the rural or rural town context.

Refer to GB Chapter 1 Section 1.5.1 for detailed definitions of rural roads and streets context classification.

## Rural Context

Rural context roads are not within a developed community and may include undeveloped land, farms, and recreation areas. In rural or undeveloped areas, pedestrians and bicyclists are less common but may be seen traveling to or from employment centers, housing clusters, recreation areas, food/beverage markets, and social service centers. Multimodal design features will be more localized.

## Rural Town Context

Rural town roads are within developed communities. The communities are generally low-density areas and may have on-street parking and sidewalks in locations.

### 2.2.2.2 Context Classes for Roads and Streets in Urban Areas

Roads and streets in urban areas may be designed for the suburban, urban, or urban core context.

Refer to GB Chapter 1 Section 1.5.2 for detailed definitions of urban roads and streets context classification.

## Suburban Context

The suburban context applies to roads and streets in the outlying portions of urban areas. These areas generally have low to medium development density, mixed land use, and drivers with higher speed expectations than in other urban contexts. In suburban or city-edge environments, pedestrians and bicyclists often travel to or near transit, multifamily housing, education campuses, and commercial centers. Multimodal design elements will support pedestrian and bicycle connectivity across a larger area.

## Urban Context

The urban context applies to high-density development and mixed land uses. On-street parking and sidewalks are more prevalent. In urban areas or town centers, pedestrians and bicyclists are generally expected, and multimodal facilities are a priority element of the roadway design.

## Urban Core Context

The urban core context has the highest density development. High-rise structures and sidewalks are present almost continuously and off-street parking (i.e., parking garages) is prevalent because of time restricted on-street parking.

## 2.2.3 Design Speed

Travelers consider speed as one of the most important factors in selecting alternative routes or transportation modes. Travelers weigh time, convenience, and money saved when deciding between public transit, driving, walking, or bicycling to their destinations. According to the GB, exclusive of the driver and vehicle capabilities, the speed of the vehicle on a road depends on the physical characteristics of the roadway, amount of roadside interference, weather, presence of other vehicles, and speed limitations (established either by law or traffic control devices).

Design speed is used to determine the selection of the design criteria for a project. Give consideration to roadside development, vertical and horizontal alignment, terrain, functional classification, context classification, traffic volumes, and other contributing factors that are not specifically mentioned but may be a factor on a project-by-project basis. When design speeds

are established, make every effort to use the highest design speed practicable to attain the desired degree of safety, mobility, and efficiency. Maintain the design speed ( $V_d$ ) of a facility at a minimum of 5 mph above the anticipated posted speed or the speed determined by a speed investigation study to be the “Reasonable Design Speed” for a particular project. The roadway designer is responsible for showing the selected design speed on the roadway title sheet with the other design data.

The design speed in the planning report for low impact bridge replacement projects pertains to the horizontal curvature recommended in the report. The actual design speed attainable will be determined by the roadway designer after reviewing grades, possible right of way damages, posted speed limit, etc.

Refer to GB Chapter 5 Section 5.2.1.1 Table 5-1 for minimum design speeds for local roads in rural areas. Design speed on local roads in urban areas is not a major factor because the typical street grid and closely spaced intersections usually limit vehicular speeds.

Refer to GB Chapter 6 Section 6.2.1.1 Table 6-1 for minimum design speeds for collectors in rural areas. The design speed for suburban collector streets should generally range from 35 to 50 mph, the design speed for urban collector streets should range from 30 to 40 mph, and the design speed for urban core collectors should range from 25 to 35 mph, depending on available right of way, terrain, adjacent development, likely pedestrian presence, and other site controls.

Refer to GB Chapter 7 Section 7.2.2.1 for minimum design speeds for arterial roads in rural areas. Design speeds for arterials in rural areas will vary based on the rural context or rural town context.

Refer to GB Chapter 7 Section 7.3.2.1 for minimum design speeds for arterial roads in urban areas. Design speeds for arterials in urban areas will vary based on the suburban context, urban context, or urban core context.

Refer to GB Chapter 8 Section 8.2.1 for minimum design speeds for freeways. Design speeds for freeways will vary based on the rural context, suburban context, urban context, or urban context.

## 2.3 Terrain Classifications

Three terrain classifications are used in North Carolina for roadway design: level, rolling, and mountainous. These classifications influence the design criteria and will be reflected in the design charts. Any reference to a slope means the rise and fall on the grade measured both parallel and perpendicular to the centerline.

Refer to GB Chapter 3 Section 3.4.1 for detailed definitions of terrain classifications.

### Level Terrain

Highway sight distances in level terrain are typically long and the roadway can be designed and constructed without significant difficulties or major expense. The roadway sight distances are typically governed by both horizontal and vertical restrictions.

### Rolling Terrain

Natural slopes regularly rise above and fall below the highway grade line in rolling terrain. The horizontal and vertical design may be limited by intermittent steep slopes in this terrain.

## Mountainous Terrain

In mountainous terrain, the natural ground is subject to rapid changes in elevation. Typically, construction requires benching and side hill excavation to achieve the desirable horizontal and vertical design.

Select only one terrain classification for each project. Base the classification on the most restrictive terrain present along the mainline alignment within the project limits. Do not rely on geographical location alone as the major factor in assigning a terrain classification. For example, a project located west of Asheville typically is thought of as rolling or mountainous terrain. A segment of the road may have land characteristics of roads in both level and rolling terrain and therefore should be classified as the more restrictive rolling terrain.

## 2.4 Highway Capacity

The roadway design engineer is responsible for establishing project design controls, such as roadway width, side slopes, alignment, drainage considerations and intersecting roads. Applicable design controls and influencing factors are needed to determine the desired capacity and level of service. Coordinate with the NCDOT Congestion Management Unit to acquire traffic information detailing the traffic volumes, number of lanes and required turning movements.

The Congestion Management Unit uses the [NCDOT Congestion Management Guidelines](#) to determine standard guidance and values for consistent traffic analysis to determine the number and configuration of lanes required and the resulting levels of service provided.

The HCM provides methodologies and procedures for evaluating multimodal performance on highways and streets in terms of operational measures and quality of service indicators.

Capacity, as defined in the HCM, is the maximum sustainable flow rate, which persons or vehicles can reasonably be expected to traverse a point or a uniform segment of a lane or a roadway during a given time period under prevailing roadway, environmental, traffic, and control conditions. Capacity is not the maximum flow rate, but rather a flow rate that can be achieved repeatedly for peak periods of sufficient demand.

The following factors greatly influence capacity and level of service:

- Roadway gradients and roadside developments
- Number, spacing, and types of crossings and intersections
- Traffic volumes and composition
- Signalization progression and interconnectivity

In general, as roadway gradients increase, capacity is reduced due to the influence on the vehicle. Speeds and sight distances may reduce flow rates and a vehicle's ability to pass other slow-moving vehicles. Use appropriate roadway grades depending on the project location. In the absence of local data, approximate typical average grades using values in the *NCDOT Congestion Management Capacity Analysis Guidelines*.

Crossings and intersections impact capacity by controlling vehicle interactions and the facility's geometric conditions. Intersections controlled by all-way stops, two-way stops, roundabouts and yields impact flow and capacity differently due to varying periodic delays. Refer to HCM Volume 3 for controlled intersection analysis.

Signal timing is interactive with geometric design. Changes to geometrics, such as adding a turn lane, must consider changes to the signal timing simultaneously. Use Department-approved



software, including the Highway Capacity Software, to simulate the operation of independent or interconnected signals. Output from these programs can be used for the analysis and evaluation of proposed designs.

The HCM contains several methods for evaluating the quality of service available to pedestrians and bicyclists traveling on different facilities in urban street settings. Refer to the [FHWA Traffic Analysis and Intersection Considerations to Inform Bikeway Selection](#) (2021) for more information and more sufficient guidance on using traffic analysis to analyze alternatives and describe impacts to all roadway users. This resource provides tips and considerations for projecting future year volumes, estimating growth rates, selecting an analysis period, and understanding impact of peak traffic periods on analysis.

### 2.4.1 Traffic Characteristics

Traffic characteristics that influence capacity and service level include vehicle type, lane or directional distribution, and driver population.

- Heavy vehicles adversely affect traffic due to their slower speeds, larger roadway head space, operating capability, and inability to keep pace with passenger cars during times of acceleration. Each vehicle type has unique operational characteristics, and the percentage of each vehicle type within a traffic stream affects the capacity of a facility.
- Traffic volumes typically do not distribute evenly between lanes due to driver's pre-positioning for downstream movements. Uneven lane distribution results in suboptimal flow rates.
- Drivers behave differently in unfamiliar conditions and should be considered during analysis.

### 2.4.2 Definitions

- Average Daily Traffic (ADT) – The most basic measure of the traffic demand for a highway is the ADT volume. The ADT is defined as the total volume during a given time period (in whole days), greater than 1 day and less than 1 year, divided by the number of days in that time period. The current ADT volume for a highway can be readily determined when continuous traffic counts are available. When only periodic counts are taken, the ADT volume can be estimated by adjusting the periodic counts according to such factors as the season, month, or day of week.
- Design Year ADT – the general unit of measure for projected ADT to some future design year. Usually, the design year is 20 years from the date of beginning construction but may range from the current year to 20 years depending on the level of operational improvement occurring as part of the project.
- Annual Average Daily Traffic (AADT) – the total volume of traffic demand for a highway for a year divided by 365 days. AADT is a simple, but useful, measurement of how busy the road is.
- Design Hourly Volume (DHV) – the DHV is sometimes used to justify the need for a traffic signal. The DHV is defined as the 30th highest hourly volume in the design year, whereas the peak hour volume (PHV) is defined as the highest hourly volume during an average day.
- Directional Design Hour Volume (DDHV) – DDHV is the traffic volume for the design hour in the predominant direction of travel, expressed as a percentage of the DHV. For

example, if during the design hour, 60 percent of the vehicles traveled eastbound and 40 percent traveled westbound, then the DDHV for the eastbound direction would be the DHV x 0.60.

Refer to HCM Volume 1 Chapter 9 for a complete list of definitions relating the capacity and traffic. Refer also to GB Chapter 2 Sections 2.3 and 2.4.

### 2.4.3 Average Daily Traffic (Current and Future Year)

Traffic volumes are a major factor in selecting design criteria. All design criteria are based on a DHV or AADT. However, on most major highways, the design is based on a DHV. The DHV is based on the 30th highest hourly volume. The design year is listed in the planning report and is usually either 10 or 20 years beyond the beginning of construction.

Update the design year traffic to 20 years for any design year traffic that is 17 years or less from the beginning of construction. For example, a project has a 20-year design period and is scheduled to be let in 2020. The design year traffic listed in the planning document is 2037. Update the traffic volumes to the year 2040. Complete these traffic updates as necessary at the beginning of the preliminary design, right of way plans, and final plans. Ensure this information matches the information shown on the Roadway Design Title Sheet; refer to RDM Part II Chapter 13 Section 13.2.6

NCDOT Traffic Survey Group collects traffic data statewide to analyze and support planning, design, construction, maintenance, operation, and research activities required to manage North Carolina's transportation system. Traffic volume maps and reports are published annually, once NCDOT has collected data for the entire state and analyzed and processed the entire set.

Refer to [NCDOT Traffic Volume Maps](#) for AADT maps and reports.

Consult the State Traffic Forecast Engineer with the Traffic Forecasting Unit and request recent roadway forecast data when determining the appropriate base and future year ADT forecasts.

Refer to [NCDOT Project Level Traffic Forecasting](#) for forms to request project level traffic forecast data.

### 2.4.4 General Guidelines for Roadway

The HCM defines two primary facility types: uninterrupted and interrupted flow facilities. Basic parameters such as volume, flow rate, and speed are parameters common to both uninterrupted and interrupted flow facilities, but density applies primarily to uninterrupted flow. Other parameters, such as saturation flow and gap, are specific to interrupted flow.

Uninterrupted flow facilities have no fixed causes of delay or interruption external to the traffic stream. Non-tolled freeways represent the purest form of uninterrupted flow because there are no fixed interruptions to traffic flow, and access is limited to ramp locations.

Interrupted flow facilities can be more challenging to analyze due to the impact of control variables, such as traffic signals and stop signs, on the overall flow of traffic. Traffic flow patterns on interrupted flow facilities are the result of vehicle interactions, facility geometry, and the frequency of access points to the facility.

Refer to RDM Part I Chapter 9 for additional capacity guidelines for interchanges and freeways, and Chapter 8 for additional capacity analysis guidelines for intersections.

Refer to HCM Volume 1 Chapter 4 for additional information on facility flow types.



## 2.5 Access Control and Access Management

Access management is the coordinated planning, regulation, and design of access between roadways, highways, and major arterials. The utilization of proper control over access is one of the most effective and economical means for maintaining the safety and utility of streets and highways. Street and driveway access connections are major contributors to traffic congestion and poor roadway facility operations. The benefits of access management include efficient and safe movement of traffic and reduced conflicts on the roadway system.

The NCDOT Policy on Street and Driveway Access to North Carolina Highways establishes uniform criteria regulating the location, design, and operation of access streets and driveways, and balances the needs and rights of property owners and roadway users.

All work performed on the state highway system shall adhere to policies set forth in Chapter 7 of the [NCDOT Policy on Street and Driveway Access to North Carolina Highways](#), and the design criteria in RDM Part I Chapter 10 Section 10.5.

## 2.6 Pedestrians, Bicyclists and Transit

### 2.6.1 Complete Streets

The [NCDOT Complete Streets Policy](#) requires designers to consider and incorporate multimodal facilities in the design and improvement of all appropriate transportation projects. This policy sets forth the protocol for developing transportation networks that encourage non-vehicular travel without compromising the safety, efficiency, or function of the facility.

The [NCDOT Complete Streets Implementation Guide](#) outlines design decisions to ensure that all users are considered in the design process and the project will not create barriers or hazards to the movements of those users. Facility design guidance based upon project area context and cross sections will be used in each stage of project planning, prioritization, and development.

Refer to GB Chapter 1 Sections 1.4 and 1.5 for definitions of the functional classification system (freeways, arterials, collectors, and local roads and streets) and context classification system (rural, rural town, suburban, urban, and urban core).

Refer to GB Chapters 5 through 8 for presentation of geometric design for local roads and streets, collector roads and streets, arterial roads and streets, and freeways, respectively.

Coordinate with the NCDOT Project Manager and NCDOT's Integrated Mobility Division on all programmed highway projects and bridge replacement projects. The Integrated Mobility Division will participate in scoping meetings and provide a written summary memo identifying facility recommendations and design guidance as appropriate.

Refer to the [NCDOT Complete Streets](#) website for additional guidance and resources.

Additional resources include the [Complete Streets Flowchart](#) and the [NCDOT Complete Streets Project Evaluation Methodology](#) which can aid the roadway designer in the evaluation of projects for Complete Streets improvements during the Project Initiation and Alignment Defined stages of the PDN. Refer to the Tools/Templates on the [Project Management](#) website for the latest version of the PDN.

## 2.6.2 Design Guidance

The RDM serves as the authoritative reference for Complete Streets design. Use cross section elements from RDM Part I Chapter 4 in each stage of project planning, prioritization, and development.

Use GB Chapter 1 in coordination with the RDM as a reference for street design.

Use the [National Association of City Transportation Officials \(NACTO\)](#) guides as supplemental references for urban and urban core street design in coordination with the RDM and AASHTO guides.

FHWA provides supplemental guidance on selecting appropriate bicycle and pedestrian facilities. The [NCDOT Bicycle and Pedestrian Design Guidance](#) provides information on countermeasures, bikeways, raised medians and other facilities.

The [NCDOT Complete Streets Implementation Guide](#) contains supplemental references to other documents useful to the roadway designer when selecting the appropriate bicycle and pedestrian facilities.

### 2.6.2.1 Pedestrian Facilities

Refer to [NCDOT Complete Streets Implementation Guide](#) for planning, designing, building, maintaining and operating pedestrian facilities

Pedestrians have a wide variety of physical abilities, ages, experiences, mobility assistance needs, and trip purposes. Some pedestrians require mobility assistance, have vision or hearing impairments or disabilities, or walk at slower speeds due to age or health condition. Children, novice bicyclists, visitors, and people with cognitive disabilities may be less able to quickly respond to crash risks or navigate complex roadways and intersections. The following table, from the 2008 [FHWA Pedestrian Safety Guide for Transit Agencies](#), summarizes pedestrian people-groups and common difficulties navigating intersections or crossing roadways, based on physical and cultural experience and abilities.

Table 2-1 Pedestrian Group Characteristics and Behaviors

Pedestrian Group	Characteristic and Behaviors
Child Pedestrians	<ul style="list-style-type: none"> <li>• May have difficulty choosing where and deciding when it is safe to cross the street.</li> <li>• May have difficulty seeing (and being seen by) drivers of all types of vehicles, including buses because of less peripheral vision and shorter stature than adults.</li> <li>• May have difficulty judging the speed of approaching vehicles.</li> <li>• May need more time to cross a street than adults.</li> </ul>
Older Pedestrians	<ul style="list-style-type: none"> <li>• May have reduced motor skills that limit their ability to walk at certain speeds or turn their heads.</li> <li>• May need more time to cross a street than younger adults.</li> <li>• May have difficulty with orientation and understanding traffic signs, so they may need more information about how to access transit and get around safely.</li> <li>• May have difficulty judging the speed of approaching vehicles.</li> </ul>
Recent Immigrants	<ul style="list-style-type: none"> <li>• May have limited understanding of English, traffic laws, or typical roadway behaviors.</li> <li>• May not understand the traffic signals that indicate when to walk.</li> <li>• May not have the experience to know how to interact safely with drivers.</li> </ul>
People with Disabilities (e.g., people using wheelchairs, crutches, canes, or people with visual or cognitive impairments)	<ul style="list-style-type: none"> <li>• May be more affected by surface irregularities in the pavement and changes in slope or grade.</li> <li>• May need more time to cross a street than people without disabilities.</li> <li>• May benefit from pedestrian signal information provided in multiple formats (audible, tactile, and visual).</li> <li>• May have trouble seeing (and being seen) by drivers of all types of vehicles due to seated position (for people using wheelchairs).</li> <li>• Pedestrians who are blind or who have low vision may have trouble detecting yielding vehicles or communicating visually with drivers in crossing at unsignalized crosswalks.</li> </ul>

Source: 2008 FHWA Pedestrian Safety Guide for Transit Agencies

Pedestrian separation is enhanced by wider buffers between the curb and pathways and with wider pathways, especially where bicycles are sharing the space.

Refer to the AASHTO *Guide for the Planning, Design, and Operation of Pedestrian Facilities* 2nd Edition and RDM Part I Chapter 4 Section 4.14 for more information on determining an appropriate width for a shared use path.

Refer to RDM Part I Chapter 4 Section 4.14 for more information about appropriate berm, buffer and sidewalk width and providing accessible routes for people with disabilities along roadways and at crossings.

### 2.6.2.2 Pedestrians – Bridges

Due to the large infrastructure investment, give special consideration to bridges when pedestrian travel is anticipated.

Refer to RDM Part I Chapter 5 Sections 5.3 and 5.4 for information regarding pedestrian accommodations on roadway bridges.

### 2.6.2.3 Bicycle Facilities

NCDOT endorses bicycle transportation as an integral part of the comprehensive transportation system. When appropriate, integrate bicycle facilities into the design of state funded transportation projects.

There are three categories of adult bicyclist design user profiles based on measures of comfort, bicyclist safety, and experience. Identify the type or design user profile of the bicyclist most likely to benefit from or be impacted by the roadway. Characteristics such as a person's comfort level, skill and experience, age, disabilities, and trip purpose influence whether they are more confident as a bicyclist or pedestrian. However, people may fit multiple profiles depending on who they are travelling with, the time of day, and physical context.

Figure 2-1 Bicyclist Design User Profiles

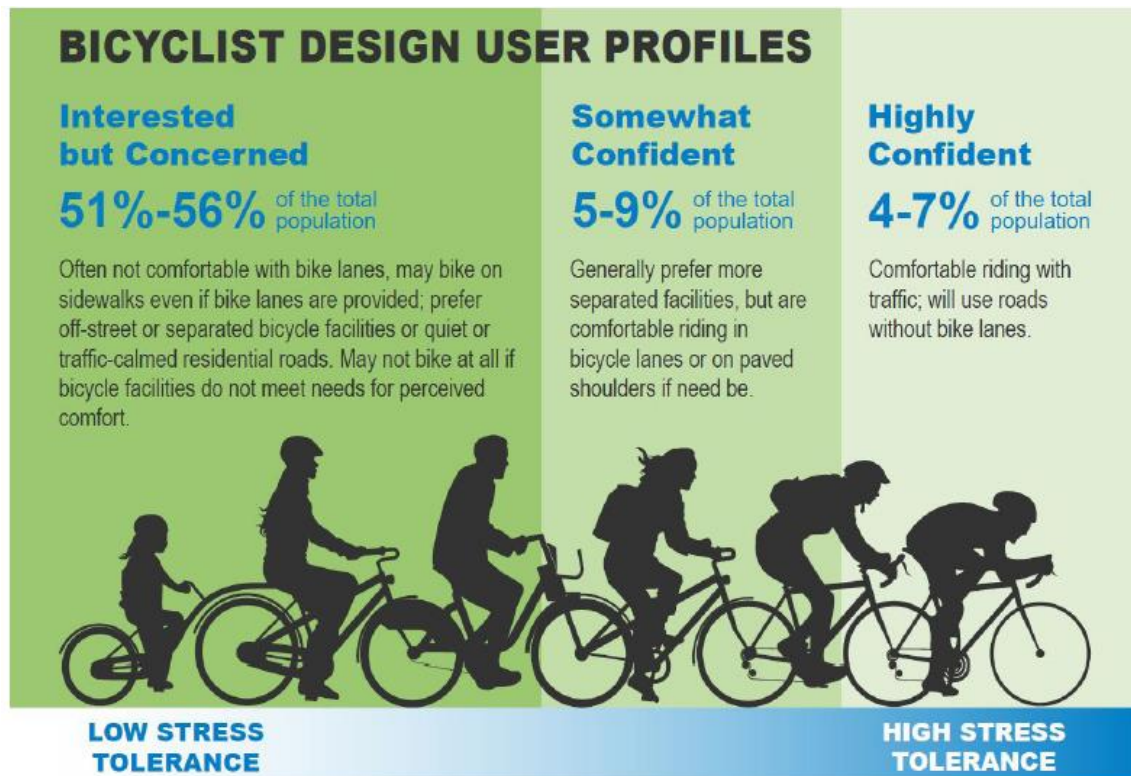

Note: The percentages above reflect only adults who have stated an interest in bicycling.

Source: FHWA Bikeway Selection Guide

Bicyclist separation is increased by both horizontal and vertical features, such as a wider marked buffer space or by vertical features such as a curb or delineator posts. As described by the figures in the [FHWA Bikeway Selection Guide](#), fully separated bikeways are preferred for urban roadways with volumes in excess of 6,000 vehicles per day and speeds over 30 miles per hour.

Figure 2-2 Fully Separated Bikeways

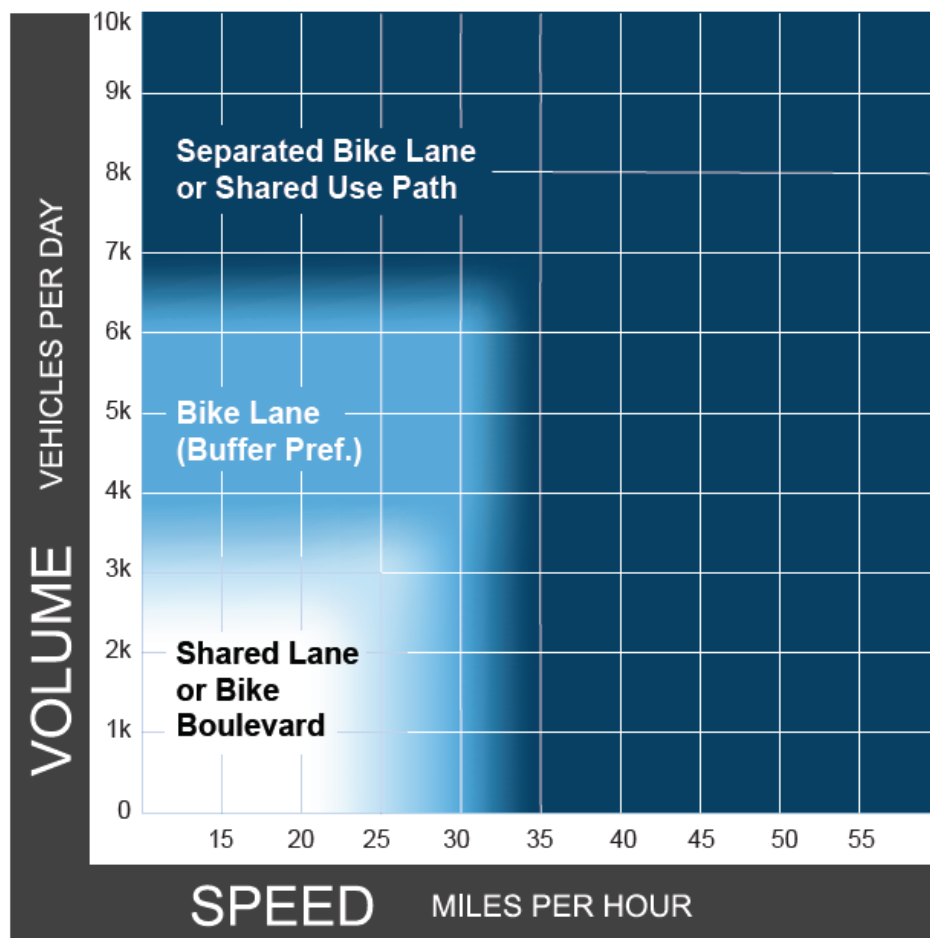

## Notes:

1. Chart assumes operating speeds are similar to posted speeds. If they differ, use operating speed rather than posted speed.
2. Advisory bike lanes may be an option where traffic volume is <3,000 ADT.

Source: FHWA Bikeway Selection Guide

Design and construct bicycle facilities in accordance with the AASHTO *Design Guidelines for Bicycle Facilities*.

### 2.6.2.4 Transit Facilities

Transit in North Carolina plays a vital role in connecting people with opportunities and encompasses a variety of modes and methods to meet the differing needs of diverse locations and communities. In more rural settings, transit could include paratransit, on-demand micro transit, or other services that do not typically require dedicated transit facilities. In urban contexts, transit modes can include fixed-route bus and higher capacity transit such as Bus Rapid Transit. Transit priority facilities such as traffic signal priority or dedicated transit lanes become more useful as transit service becomes frequent (15-minute headways) or as multiple bus routes use a roadway (trunkline).

Selection of transit facilities for a roadway will be heavily dependent on coordination with the local transit agency and localized context. Consider transit priority infrastructure (including the number of transit vehicles using the corridor), congestion, ridership, and safety in order to prioritize the movement of people instead of vehicles.

Refer to the TRB Transit Cooperative Research Program *Report 183: A Guidebook on Transit-Supportive Roadway Strategies*, Chapter 4 for guidance on selecting the appropriate transit advantage facility.

Refer to the [Statewide Freeway and Street-based Transit \(FAST\) Network Implementation Playbook](#), for guidance on a suite of transit infrastructure improvements customized to North Carolina that, when integrated as part of the roadway network in a systemic manner, will enhance overall transit speed and reliability.

Refer to RDM Part I Chapter 4 Section 4.16 for detailed design guidance on transit facilities.

## 2.7 Typical Section Selection

### 2.7.1 Selecting a Typical Section

Select the typical section based on sound engineering principles with primary emphasis being placed on the type of facility, traffic volumes, terrain, availability of right of way, grading, guardrail construction, and economics. Consult the 2019 [Highway Typical Sections for Use in SPOT Online](#) document that accompanies the [NCDOT Complete Streets](#) for typical section selection guidance. The SPOT Online typical sections can be used during conceptual design as part of the express design process. Use engineering judgement to develop and refine the projects typical section.

Consider several design combinations on projects of major importance and where a significant savings can be realized. After the design combination is chosen, conduct an analysis to select a safe and economical highway typical section. This analysis may determine it is necessary to revise the typical section in one or more of the following ways:

1. Reduce right of way takings
2. Improve grading operations
3. Utilize waste material to flatten slopes which will provide greater roadside clearances and may sometimes eliminate the need for guardrail
4. Reduce wetland taking in environmentally sensitive areas

Refer to RDM Part I Chapter 4 for additional guidance on typical section elements and criteria.

Refer to RDM Part II Chapter 17 for additional guidance on design exceptions related to the typical section.

### 2.7.2 Lane Widths (Shoulder Sections)

For capacity purposes and when feasible, design lane widths at 12 feet to provide the highest level of service. However, on some urban projects, the lane widths may have to be reduced to 11 feet. Lane widths less than 12 feet in width will be reviewed and approved by the Project Team.

Refer to RDM Part I Chapter 3 Section 3.3.3 for minimum pavement widths based on design speeds and traffic volumes.

Refer to GB Chapter 4 Section 4.3 for additional information.



### 2.7.3 Lane Widths (Curb & Gutter Sections)

Lane widths in a curb and gutter section can vary based on the functional classification and context of the facility. The recommended travel lane width is 12 feet, and the minimum width is 11 feet. Obtain approval from the roadway team lead or Division Manager for travel lane widths that deviate from those stated above.

### 2.7.4 Pavement Cross Slope

The normal crown slope is typically 2 percent for all pavement compositions. Show a grade/crown point on the typical section so the engineer will know where this slope is to begin.

- Normal two-lane roadways – grade point is on the centerline with conventional roof top slopes.
- Where two lanes of a future four-lane section are being constructed – a roof top slope shall also be used.
- Divided highway sections with a raised median – grade point is located at the centerline.
- Divided sections, such as those with a depressed median with two or three lanes in each direction – grade point is commonly on the median edge of the travel lane.

In a normal crown section, all lanes will be sloped in the same direction from the pavement edge adjacent to the median to the outside edge of pavement. In the future, when lanes are constructed in the median, slope the additional lane or lanes to the median. On a divided section when two lanes are being constructed in each direction initially and provisions are being made to add a maximum of two lanes in each direction in the median, slope the initial lanes being constructed away from the edge of median. Slope future inside lanes into the median.

A 2.5 percent cross slope can be considered for roadways east of I-95 and other roadways with flat grade; however, should not be used on two- or four-lane roadways with each lane crowned at the centerline of pavement.

When three or more lanes are sloped in the same direction on multilane highways, design each successive pair of lanes outward with an increased slope. Design the two lanes adjacent to the crown at the normal minimum slope, and for each successive pair of lanes outward, increase the rate by about 0.5 to 1 percent. In areas of intense rainfall, a steeper cross slope may be needed to facilitate roadway drainage. Coordinate with the NCDOT Hydraulics Unit on the cross slopes needed for proper drainage.

Compute grades in locations where future lanes will be constructed in the median to ensure that the future construction can be accommodated. In superelevated sections, and especially where structures are located, it may be necessary to set separate grades. In these locations, make sure that the relative grades of the inside edges of the future lanes will allow future ditches or median barriers to be constructed.

Refer to RDM Part I Chapter 7 Section 7.7 for additional guidance for pavement surface slopes to minimize or avoid hydroplaning.

### 2.7.5 Pavement Composition

Design proposed pavement in accordance with the pavement design prepared by the State Pavement Design Engineer. Consider total depth of surface and intermediate courses with curb and gutter to be equal the depth of gutter at the edge of pavement (typically 7 inches).

Refer to the most current [NCDOT Asphalt QMS Manual](#) for asphalt mix types, pavement layer depth guidelines and application rates to be used on all new and rehabilitated projects.

### 2.7.6 Existing Pavement

Include resurfacing recommendations in the pavement design. On widening projects, it may be necessary to establish a new grade line.

### 2.7.7 Pavement Edge Construction

Unless otherwise instructed by the State Pavement Design Engineer, treat pavement edge construction as shown in Figure 2-3. It is not necessary to tie down edge of pavement transitions with computed alignment on most projects.

The recommended treatment under curb and gutter is minimum 4 inches of B25.0 or minimum 6 inches of aggregate base course. Design the final treatment in accordance with the final pavement design and/or coordinated with the Division.

Figure 2-3 Pavement Edge Construction with Flexible Pavement

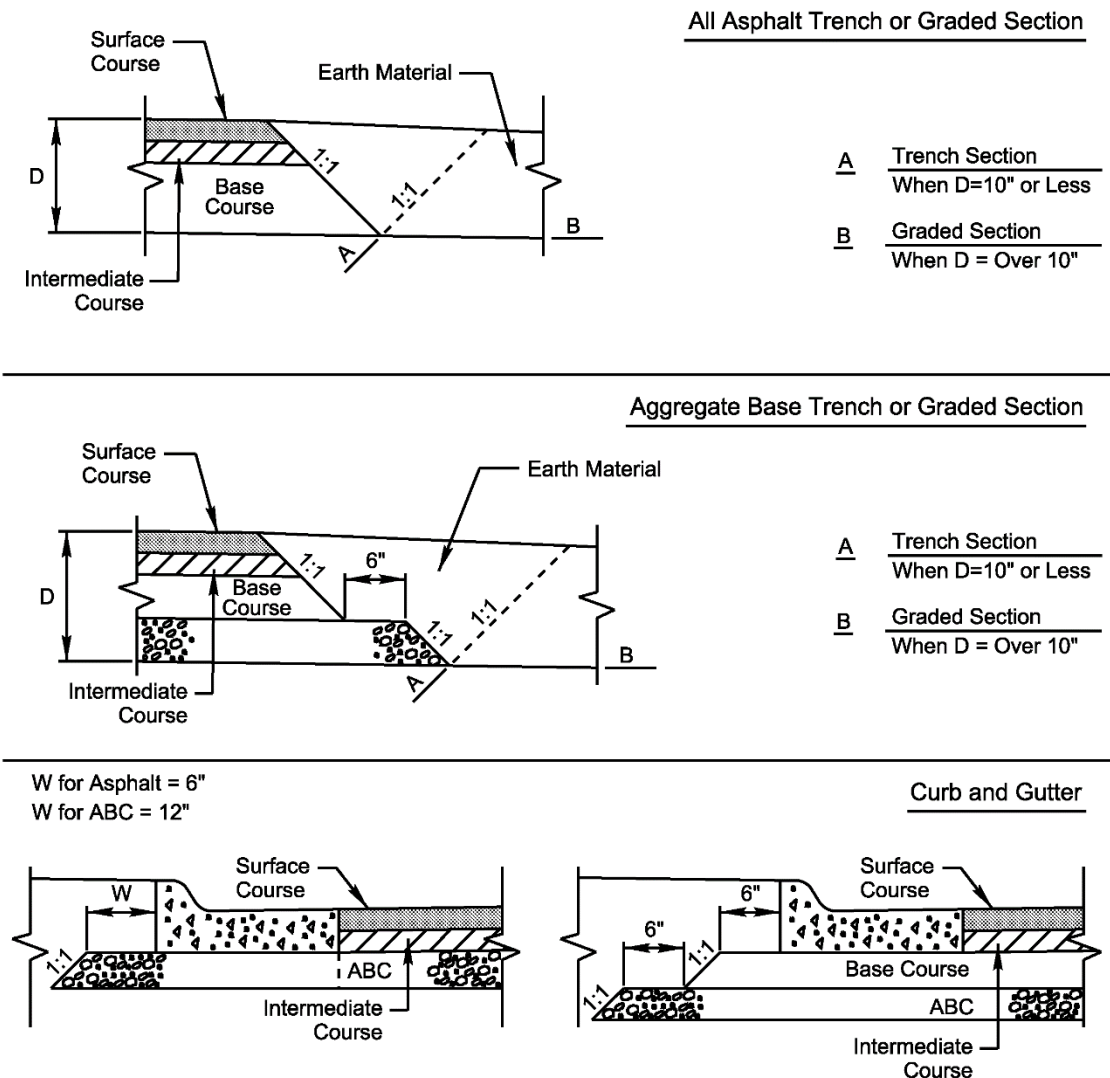
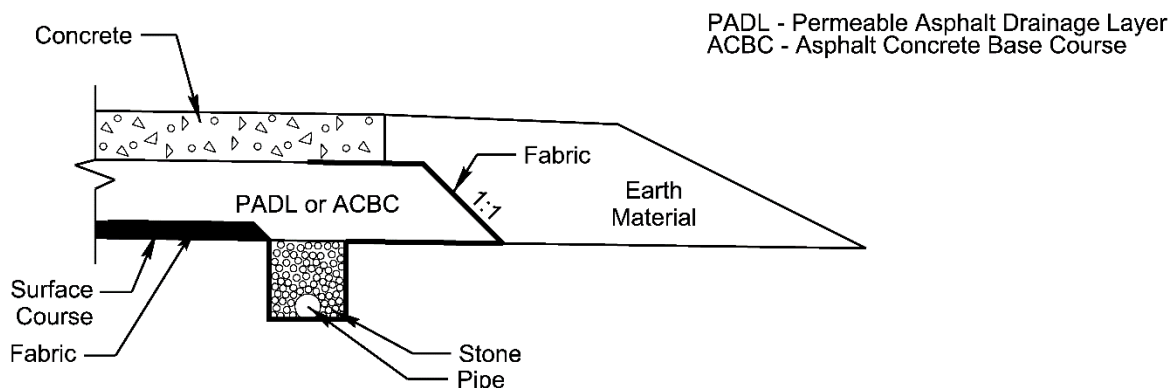



Figure 2-4 Pavement Edge Construction with Shoulder Drains



Note: The detail above serves as an example of what a roadway designer may receive from the Pavement Design Unit upon being notified that shoulder drains should be included in the plans.

## 2.8 Safety

Give primary consideration to safety characteristics during design. The establishment of sufficient right of way and adequate horizontal and vertical alignment is essential from a safety standpoint and allows for future upgrades and expansion without additional highway funds.

Refer to the AASHTO *Highway Safety Manual* 1st Edition for additional safety considerations during design.

## 2.9 Environment

Construction and operation of streets and highways frequently produces an adverse effect upon the environment. Early consideration and resolution of environmental issues can avoid costly delays and modifications that may compromise the quality and efficiency of operation. Topics often encountered include the following:

- Air quality
- Coastal zone resources
- Agriculture
- Floodplains
- Hazardous waste and brownfields
- Noise
- Roadside vegetation
- Safe Drinking Water Act
- Water quality
- Watersheds management
- Wetlands
- Wild and scenic rivers and wilderness areas
- Wildlife and threatened and endangered species

- Wildlife, habitat, and ecosystems

The NCDOT Environmental Policy Unit helps staff ensure compliance with the National Environmental Policy Act and other environmental policies and regulations. If federal funds are used, federal contracting, right of way, and National Environmental Policy Act processes must be followed.

The Environmental Operations Section manages environmental compliance, National Pollutant Discharge Elimination System management, and hazardous waste engineering. This section closely corroborates with the six sections of Roadside Environmental and other units within the Division of Highways on areas of environmental concern.

Include an environmental evaluation of impacts in the initial roadway design process. The drainage specialist will perform the drainage analysis and design, flood data information, stormwater pollution prevention plan and all information required to obtain the necessary environmental permits.

Work with the Environmental Analysis Unit and Division environmental staff to avoid and minimize impacts to Section 4(f) properties. Section 4(f) properties include the following:

- Significant publicly owned public parks
- Recreation areas
- Wildlife or waterfowl refuges
- Publicly or privately owned historic site listed or eligible for listing on the National Register of Historic Places

Refer to the AASHTO *Practitioner's Handbook* for additional information on environmental and Section 4(f) compliance.

## 2.10 Design of On-Site Detours and Median Crossovers

~~Traffic volumes and accident history on a roadway significantly impact the design of long-term temporary alignments. Long-term stationary work is defined as work that occupies a location for more than 3 days. Provide an on-site temporary alignment design, including on-site detours and median crossovers as part of the roadway plans. Evaluate the required detour or cross over and design using either alignments and profiles, or NCDOT Standards. If additional right of way is needed for any temporary alignment, a roadway detail sheet and right of way plan sheet may be required. Include typical sections for temporary alignments and/or temporary widening on the roadway typical section sheets. Include required cross-reference notes on both the roadway plans and traffic management plans. Show the design on a separate sheet as a roadway detail if needed to minimize plan sheet clutter.~~ Often temporary detours and median crossovers are identified during scoping of the project through coordination with the Work Zone Traffic Control Engineer and Division. The roadway designer will include the design criteria for temporary detours and median cross overs with the main line and Y lines criteria for approval. For additional locations where temporary on-site detours or crossovers are identified during the design phase, the Work Zone Traffic Control Engineer will inform the roadway designer that a proposed horizontal and vertical alignment is required. Approval of design criteria for the additional temporary condition is needed before proceeding with the design.

Consider the following when designing on-site detours and median crossovers:

- Include on-site detours and median crossovers as part of the roadway plans

- Additional right of way or easements may be necessary to acquire for a temporary on-site detour
- Coordinate with the Hydraulics Unit to ensure temporary drainage needs have been addressed
- Show the detour alignments on the proposed design plan sheets. The proposed alignment should be shown on the detour plan sheets
- Include typical sections for temporary alignments on the roadway typical section sheets
- Include cross-reference notes as appropriate on both the roadway plans and traffic management plans
- Include cross sections and earthwork quantities for on-site detours and median crossovers
- A roadway detail sheet may be required for a temporary on-site detour

The roadway designer should obtain the duration expectation and traffic for the detour temporary pavement design request letter.

~~Base detour alignment designs on the project detour design criteria form and coordinate with the Division and Work Zone Traffic Control. The minimum acceptable design standards for each classification are as follows. Refer to the Work Zone Traffic Control Design Manual for any deviations.~~

Determine the appropriate shoulder width based on the context of the project, while meeting or exceeding the minimum criteria shown below. Refer to the Work Zone Traffic Control Design Manual for any deviations.

Use a minimum total shoulder width of 6 feet with a 4-foot full depth paved shoulders. Where temporary guardrail is used, place the face of guardrail at the outside edge of the full depth paved shoulder to provide a 4-foot offset from the edge of the travel lane. For situations using concrete barrier, place the concrete barrier on pavement at the outside edge of the paved shoulder to allow for a 2 foot minimum offset from the travel lane to the barrier. In absence of adjacent temporary barrier, design shoulders widths based on the Work Zone Traffic Control Design Manual Chapter 3.

Ensure the surface of the proposed roadway is reviewed by the hydraulics engineer for areas that do not drain well. Hydroplaning during periods of rain can be created by long, level sections of pavement and by concrete barrier placed along the edge of the roadway. Use grade and superelevation changes or special drainage features to correct any potential hydroplaning problems.

### 2.10.1 Interstate and Freeways

~~Design the speed (V) of horizontal and vertical curves for temporary alignments on interstates and freeways at the same or greater than the posted speed limit prior to the implementation of a reduced work zone speed limit. Design temporary alignments to avoid the need for a reduction in the posted speed limit or number of lanes of traffic. It is desirable for the design speed (V) of horizontal and vertical curves for temporary alignments on interstates and freeways to be at the same or greater than the posted speed limit. The roadway designer should coordinate with Work Zone Traffic Control and the Division to determine the appropriate design speed (V) of an on-site detour and/or median crossover. Any speed reduction needs to be approved by the Regional Traffic Engineer, State Traffic Engineer and the posted work zone speed limit~~

ordinances signed accordingly. Coordinate any speed limit reduction as soon as the need is identified. Design temporary alignments to avoid the need to reduce the number of traffic lanes.

#### Exceptions:

- ~~For short term median crossovers used for operations lasting one work period or less, the design speed (V) of horizontal and vertical curves may be 20 mph below the existing posted speed limit prior to the implementation of a reduced work zone speed limit. Limit the distance between the median crossovers to 1/2-mile.~~
- ~~For short duration lane closures (work that occupies a location for up to 1 hour), the design speed does not have to be maintained for cross-over designs. When traffic control phasing allows short duration lane closures during daylight hours, design detours to maintain the existing number of lanes during peak hours.~~
- ~~Certain interstate and freeway routes may have low traffic volumes. The Regional Work Zone Traffic Control Engineer will determine on a case-by-case basis if long duration lane closures that occupy a location for more than one work period are permitted.~~

~~Ensure the surface of the proposed roadway is reviewed by the hydraulics engineer for areas that do not drain well. Hydroplaning during periods of rain can be created by long, level sections of pavement and by concrete barrier placed along the edge of the roadway. Use grade and superelevation changes or special drainage features to correct any potential hydroplaning problems.~~

~~Design the minimum shoulder width at 6 feet wide with 4-foot paved shoulders. Maintain the clear zone and recovery area in accordance with the latest AASHTO Roadside Design Guide (RDG) or protect the area with an approved roadside barrier system. In areas where guardrail or concrete barrier is placed close to the travel lanes, take special care to avoid creating an unpaved drop-off area between the edge of paved shoulder and the face of the concrete barrier or guardrail. Place the face of the concrete barrier or guardrail flush with the edge of the paved shoulder to eliminate this problem. Use a minimum offset of 2 feet from the edge of travel lane to the temporary guardrail or concrete barrier.~~

## 2.10.2 Expressways and Major Arterials

The design speed (V) of horizontal and vertical curves for temporary alignments on expressways and major arterials with partial or no control of access may be lowered to ten miles per hour below the posted speed limit. Base the number of lanes required for the detour of an expressway or major arterial in operation during peak hours on the current average daily traffic.

**Table 2-2 Required Number of Lanes for Detour**

Unrestrictive Traffic (ADT)	During Peak Hours
0 to 30,000	Two lanes (one in each direction)
30,001 to 50,000	Four lanes (two in each direction)
50,001 to 80,000	Six lanes (three in each direction)
80,000 +	Eight lanes (four in each direction)

### 2.10.3 Minor Arterials, Collectors, and Local Roads

During construction activity, it is permissible to control traffic in a one-lane two-way pattern controlled by a flagging operation. Do not schedule or permit this operation to occur during peak hours of that facility.

A temporary traffic signal may be utilized in lieu of a flagger during one-lane, two-way operation in special conditions approved by the [Regional WZTC Engineer](#). Two-way peak hour traffic volume should not exceed 670 vehicles.

For an on-site detour to be used without a temporary traffic signal or flagger, design as a two-lane, two-way, with a minimum design speed of 40 mph.

Maintain design speed of the detour at not more than 10 mph below the posted speed of the existing roadway.

~~Design shoulder widths to meet the AASHTO guidance for the designated roadway classification. Maintain the clear zone and recovery area in accordance with the latest AASHTO Roadside Design Guide or protected with an approved roadside barrier system. In areas where guardrail or concrete barrier is placed close to the travel lanes, take special care to avoid creating an unpaved drop-off area between the edge of paved shoulder and the face of the concrete barrier or guardrail. It is preferred that the face of the concrete barrier or guardrail be placed flush with the edge of the paved shoulder to eliminate this problem. Maintain a minimum offset of 2 feet from the edge of travel lane to the guardrail or concrete barrier.~~

When a one-lane, two-way bridge structure is being replaced, a similar one-lane unsignalized temporary detour structure may be utilized. In this situation, design the sight distance to allow the entire bridge travelway to be seen from either approach. Two-way ADT must be 1,000 VPD or less and the detour structure should be adjacent to the existing structure, such that the detour approach alignments are operating with essentially the same traffic pattern as existing.

## 2.11 Off-Site Detours

Where acceptable alternative routes exist in reasonable proximity to the project, use alternate routes to re-route as much traffic as possible. Before making a final determination, visually inspect all potential detour routes to evaluate the condition of the existing pavement and bridges.

If the adequacy of the existing pavement is questionable, or if it is determined that additional surfacing is required to enable the selected detour route to carry the additional traffic, consult the Pavement Design Engineer. It will also be necessary to consult with the Federal Highway Administration on projects with federal funding, and to coordinate with Project Management. Where municipal streets are required for an off-site detour, coordination and approval from the municipality is required.

This page intentionally left blank.

# Chapter 3 Design Elements

## 3.1 Introduction

The alignment of a roadway consists of multiple design elements that together should provide a facility that achieves a safe and efficient design. These elements of design include sight distance, horizontal alignment, vertical alignment, and superelevation.

## 3.2 Sight Distance

### 3.2.1 General Considerations

Sight distance is the length of roadway over which an object of a specific height is continuously visible to a driver. Use design criteria including roadway classification, design speed, horizontal alignment and vertical alignment to provide adequate sight distance for the proposed facility. Provide sufficient sight distance to ensure a vehicle can operate in a safe and efficient manner. Three types of sight distance are discussed below: stopping sight distance, decision sight distance, and passing sight distance. For each of the three sight distance calculations, the height of the driver's eye is considered to be 3.5 feet above the road surface. The height of an object is 2 feet above the roadway for stopping and decision sight distances, and 3.5 feet for passing sight distance. Select the appropriate sight distance methodology for the project under design.

Refer to GB Chapter 3 Section 3.2.1 for more detail on sight distance general considerations.

### 3.2.2 Stopping Sight Distance

Stopping sight distance is the distance a driver needs to be able to see to prevent collision with an object in the roadway. The total distance required is the sum of brake reaction distance (the distance a vehicle travels from the time the driver sees an object requiring a stop, to the time brakes are applied) and braking distance (the distance required for the vehicle to stop when the brakes are applied) for level roadways. Adjust the stopping sight distance calculation as needed when the roadway grade is greater or less than 0 percent. Table 3-1 below provides the stopping sight distances for level roadways as well roadways with grades.

Table 3-1 Stopping Sight Distance on Grades

Design Speed (mph)	Stopping Sight Distance (ft)						
	Level	Downgrades			Upgrades		
	0%	3%	6%	9%	3%	6%	9%
15	80	80	82	85	75	74	73
20	115	116	120	126	109	107	104
25	155	158	165	173	147	143	140
30	200	205	215	227	200	184	179
35	250	257	271	287	237	229	222
40	305	315	333	354	289	278	269
45	360	378	400	427	344	331	320
50	425	446	474	507	405	388	375
55	495	520	553	593	469	450	433
60	570	598	638	686	538	515	495
65	645	682	728	785	612	584	561
70	730	771	825	891	690	658	631
75	820	866	927	1003	772	736	704
80	910	965	1035	1121	859	817	782
85	1010	1070	1149	1246	949	902	862

Source: GB Chapter 3 Section 3.2.2 Tables 3-1 and 3-2 (information combined into one table).

Refer to GB Chapter 3 Section 3.2.2 and GB Tables 3-1 and 3-2 for more detail on stopping sight distance.

### 3.2.3 Decision Sight Distance

Decision sight distance is the distance needed by a driver to detect an unexpected object on a roadway, recognize the object, and react to the object by determining the appropriate speed and path to avoid the object. Decision sight distance is greater than stopping sight distance because it provides a margin of error to allow a driver time to complete complex maneuvers at the same or reduced speed.

Refer to GB Chapter 3 Section 3.2.3 and GB Table 3-3 for more detail on decision sight distance.

### 3.2.4 Passing Sight Distance

Passing sight distance is the length of roadway required for a driver to safely make a passing maneuver without colliding with a vehicle in the opposite lane. It also allows a driver to abort the passing maneuver. The three main components of passing sight distance are: distance traveled during perception-reaction time and acceleration into opposing lane, distance required to pass in opposing lane, and distance necessary to clear the slower vehicle.



### 3.2.4.1 Passing Sight Distance for Two-Lane Roadways

Minimum passing sight distance is based on the warrants for no-passing zones presented in the [FHWA Manual on Uniform Traffic Control Devices](#) (FHWA MUTCD). The passing sight distance provided on a two-lane roadway should be greater than the stopping sight distance. Base the passing sight distance on a single passenger vehicle passing a single passenger vehicle.

Refer to GB Chapter 3 Section 3.2.4 and GB Table 3-4 for more detail on passing sight distance for two-lane roadways.

### 3.2.4.2 Passing Sight Distance for Multilane Highways

Passing maneuvers on multilane roadways and streets with two or more lanes in each direction of travel are expected to occur within the limits of the travel way for each direction of travel. Therefore, passing sight distance is not a factor to be considered on multilane highways.

Refer to GB Chapter 3 Section 3.2.5 for more detail on sight distance for multilane highways.

## 3.3 Horizontal Alignment

The horizontal alignment is the route of the road, geometrically considered a series of tangents, horizontal curves, and spiral transitions. Factors that often influence the location of a horizontal alignment are speed, superelevation, and travel way widths. Horizontal curves provide transitions between two tangent sections. Superelevation helps the driver to negotiate through the horizontal curve and is influenced by design speed of the roadway and the radius of the horizontal curve.

### 3.3.1 General Considerations

The horizontal alignment of a roadway and its associated design criteria should be consistent with the type of facility, surrounding topography, and other design features. Consider environmental variables (wetlands, historical properties, Section 4(f) properties), right of way, utilities, existing and proposed adjacent development, and drainage patterns when developing the horizontal alignment for a roadway. In areas where environmental or right of way impacts are a constraint, minimum design criteria can be considered.

Refer to GB Chapter 3 Section 3.3.2 for more detail on horizontal alignment general considerations.

### 3.3.2 Spiral Curves

Spiral curves are used to provide a smooth transition between tangent sections and horizontal curves. Spirals provide a natural path for drivers entering and exiting curves while minimizing encroachment into adjacent lanes.

Spiral curves are required on interstates, freeways, expressways, and major arterials. Where terrain and topography restrict their use, the roadway designer will have the option to eliminate spirals on collector roads, local roads and streets, and on minor arterials with a posted speed of 45 mph (50 mph design speed) or less. Do not use spiral curves on roadway facilities that have curb and gutter. Due to constructability issues with deck pours, avoid spirals on bridges. In all cases, a spiral should not begin or end on the bridge. In special cases where spirals cannot be avoided on bridges, design increment spacing to be equally spaced as a multiple of the bridge span and set transitions at substructure elements. Coordinate spiral placement on bridges with NCDOT Structures Management Unit.

Design spiral curves long enough so superelevation runoff can be completed over the spiral. Tangent runoff is applied prior to the spiral curve and full superelevation is attained at the end of the spiral curve or the beginning of the circular curve.

Refer to GB Chapter 3 Equations 3-26 and 3-27 to calculate the minimum length of spiral curve and GB Chapter 3 Table 3-19 for desirable lengths for spiral curves.

Refer to GB Chapter 3 Section 3.3.8.4.4 and 3.3.8.4.5 for additional guidance on the maximum and desirable length of spiral. Consideration is needed to limit the length of spirals since excessive spiral lengths can contribute to hydroplaning. Refer to GB Chapter 3 Equation 3-29 for guidance on calculating a conservative maximum length of spiral.

On high-speed facilities where the horizontal curve requires a superelevation of 3 percent or less, the spiral curve may be eliminated to avoid long superelevation transitions. Coordinate with NCDOT Roadway Design Unit and the hydraulic designer to determine if the spiral curve should be eliminated.

Refer to GB Chapter 3 Section 3.3.8 for more detail on spiral curves.

### 3.3.2.1 Compound Spirals

Use compound spirals between two curves if the radius of one curve is twice the radius of the second curve. Use compound spirals also on all interstates, freeways, expressways, arterials, and on ramps in interchange areas as the preferred method to change superelevation rates.

### 3.3.3 Traveled Way Widths

Minimum traveled way and shoulder widths are based on the classification of the roadway, the design speed, and the specified design volume (vehicles/day). Discuss any reductions to the traveled way or shoulder widths with the Roadway Design Unit team lead. For reconstruction projects, the existing travel lane and usable shoulder widths should not be reduced below existing conditions. The following tables provide minimum width of traveled way and shoulders for rural arterials, collectors, and local roads.

Table 3-2 Minimum Width of Traveled Way and Usable Shoulder for Rural Arterials

Design Speed (mph)	Minimum Width of Traveled Way (ft) <sup>a</sup> for Specified Design Volume (veh/day)		
	under 400 <sup>c</sup>	400 to 2000	over 2000
40	20	22	24
45	20	22	24
50	22	22	24
55	22	24	24
60	22	24	24
65	22	24	24
70	22	24	24
75	22	24	24
All speeds	Width of Usable Shoulder (ft) <sup>b</sup>		
	4	6	8

<sup>a</sup> On roadways to be reconstructed, an existing 22-foot traveled way may be retained where the alignment is satisfactory and there is no crash pattern suggesting the need for widening.

<sup>b</sup> Preferably, usable shoulders on arterials in rural areas should be paved; however, where volumes are low or a narrow section is needed to reduce construction effects, the paved shoulder width may be a minimum of 2 feet provided bicycle use is not intended to be accommodated on the shoulder.

<sup>c</sup> Where frequent use by trucks is anticipated, additional traveled way width should be considered.

Source: GB Chapter 7 Section 7.2.3 Table 7-3

Table 3-3 Minimum Width of Traveled Way and Shoulders for Collector Roads

Design Speed (mph)	Minimum Width of Traveled Way (ft) for Specified Design Volume (veh/day)		
	under 400	400 to 2000	over 2000
20	20 <sup>a</sup>	20	22
25	20 <sup>a</sup>	20	22
30	20 <sup>a</sup>	20	22
35	20 <sup>a</sup>	22	22
40	20 <sup>a</sup>	22	22
45	20	22	22
50	20	22	22
55	22	22	22 <sup>b</sup>
60	22	22	22 <sup>b</sup>
65	22	22	22 <sup>b</sup>
All speeds	Width of Shoulder on Each Side of Road (ft)		
	2	4	6

<sup>a</sup> An 18-foot minimum width may be used for roadways with design volumes under 250 veh/day.

<sup>b</sup> Consider using lane width of 24 feet where substantial truck volumes are present or agricultural equipment frequently use the road.

Note: See GB text for discussion of roadside barrier and off-tracking considerations.

Source: GB Chapter 6 Section 6.2.2 Table 6-5

Table 3-4 Minimum Width of Traveled Way and Shoulders for Two-Lane and Local Roads in Rural Areas

Design Speed (mph)	Minimum Width of Traveled Way (ft) for Specified Design Volume (veh/day)		
	under 400	400 to 2000	over 2000
15	18	20 <sup>a</sup>	22
20	18	20 <sup>a</sup>	22
25	18	20 <sup>a</sup>	22
30	18	20 <sup>a</sup>	22
35	18	20 <sup>a</sup>	22
40	18	20 <sup>a</sup>	22
45	20	22	22
50	20	22	22
55	22	22	22 <sup>b</sup>
60	22	22	22 <sup>b</sup>
65	22	22	22 <sup>b</sup>
All speeds	Width of Graded Shoulder on Each Side of the Road (ft)		
	2	3	6

<sup>a</sup> For roads in mountainous terrain with design volume of 400 to 600 veh/day, an 18-foot traveled way width may be used.

<sup>b</sup> Consider using traveled way width of 24 feet where substantial truck volumes are present or agricultural equipment frequently uses the road.

Source: GB Chapter 5 Section 5.2.2 Table 5-5

Widening the traveled way on certain horizontal curves is needed for two reasons:

1. The rear wheels of the vehicle track inside the front wheels negotiating the curve.
2. The driver cannot steer the vehicle in the center of the lane.

Refer to GB Chapter 3 Section 3.3.10 Tables 3-24a and 3-25 for more detail on traveled way widening on horizontal curves.

### 3.3.4 Widths for Turning Roadways at Intersections

Design width of pavement for turning roadways is based on traffic conditions and edge treatment. Factors for traffic conditions are the radius of the inner edge of pavement and the operation of the roadway. The operation of the roadway is divided into three cases:

- Case I – one-lane, one-way operation, no provision for passing a stalled vehicle
- Case II – one-lane, one-way operation, with provision for passing a stalled vehicle
- Case III – two-lane operation, either one-way or two-way

The use of an edge treatment such as vertical curb may require additional pavement width depending on if the curb is placed on one or both sides and how the road operates (Case I, II, or III). Lane widths may also be reduced if stabilized shoulder is provided.

Refer to GB Chapter 3 Section 3.3.11 Tables 3-27 through 3-30 for more detail on widths for turning roadways.

## 3.4 Superelevation

Superelevation is the rotation of the pavement cross slope on the approach and through a horizontal curve. Superelevation assists the driver by counteracting the effect of centrifugal force and reducing the possibility of a vehicle overturning. The maximum superelevation used on a roadway is based on multiple variables such as roadway classification, terrain, climate, highway setting (rural or urban), and design speed.

The maximum superelevation rate most commonly used is 8 percent. Rates as high as 10 percent may be used to facilitate drainage, but rates of 6 percent or less are recommended in areas with snow and ice. Use a maximum superelevation rate of 4 percent with a curb and gutter typical section in urban areas where travel speeds are lower due to traffic congestion or adjacent land usage. Minimize or omit superelevation at intersection locations where travel speeds are low. On structures, do not use superelevation more than 6 percent and keep all superelevation transitions outside the limits of the structure.

**Table 3-5 Superelevation Guidelines**

Classification	Location & Condition	Superelevation <sup>1, 4, 5</sup> <u>Table to be Used</u>
Interstates & Freeways	<ul style="list-style-type: none"> <li>Statewide</li> </ul>	.08 or .10 <sup>2</sup>
Ramps & Loops	<ul style="list-style-type: none"> <li>Statewide</li> </ul>	.08
<del>Flyovers (Directional ramps with bridges)</del>	<ul style="list-style-type: none"> <li><del>Statewide</del></li> </ul>	<del>.06</del>
<u>Rural</u> Arterials & <del>Rural</del> Collectors	<ul style="list-style-type: none"> <li>Statewide</li> <li><del>Limited Access</del></li> </ul>	.08
<u>Urban</u> Arterials & <del>Urban</del> Collectors with <u>greater than 60-50 mph design speed or greater</u>	<ul style="list-style-type: none"> <li>Statewide</li> <li><del>Partial or no control of access</del></li> </ul>	.06
Urban Collectors with 50 mph or less design speed	<ul style="list-style-type: none"> <li>Statewide</li> <li>Curb &amp; Gutter or shoulders with driveways</li> </ul>	.04
<del>Bridge replacement projects, Local Roads, &amp; Secondary Roads</del>	<ul style="list-style-type: none"> <li>Statewide</li> </ul>	.04 or .06 <sup>3</sup>
<u>Bridges</u>	<ul style="list-style-type: none"> <li><del>Statewide</del></li> </ul>	<del>.06</del> <sup>4</sup>

Notes:

- Refer to GB Chapter 3 Section 3.3.5 for particular design superelevation tables the designer should use.
- Do not use in locations susceptible to icy conditions.
- Choose superelevation table that fits characteristics of area.
- For cored slab and box beam bridges, do not exceed a .04 superelevation.
- For alignments with bridges, design the curve radius so that superelevation on the bridge does not exceed .06.

Refer to GB Chapter 3 Section 3.3 for design superelevation tables and more detail on superelevation.

## 3.5 Vertical Alignment

The vertical alignment of a roadway is made up of a series of straight grades and vertical curves. Vertical curves provide a smooth transition from one straight grade to another. The terrain of the roadway is an important element of the vertical alignment and is classified as level,

rolling, or mountainous. Maximum grades of a vertical alignment are dependent upon the roadway classification, terrain, and design speed.

### 3.5.1 Maximum Grades

The maximum grade of a roadway is based on the classification of the roadway, the terrain, and the design speed. Avoid use of maximum grades whenever possible when developing a vertical alignment. Limit the use of grades steeper than the maximum to cases where the grade is for a short length (less than 500 feet) or for low-volume roadways in rural areas.

Refer to GB Chapter 3 Section 3.4 for more detail on maximum grades.

Refer to the following tables in the GB for maximum grades for specific roadway classifications:

- Local roads – GB Chapter 5 Table 5-2
- Collectors (rural) – GB Chapter 6 Table 6-2
- Collectors (urban) – GB Chapter 6 Table 6-7
- Arterials (rural) – GB Chapter 7 Table 7-2
- Arterials (urban) – GB Chapter 7 Table 7-4a
- Freeways – GB Chapter 8 Table 8-1

### 3.5.2 Minimum Grades

Use a minimum grade of 0.5 percent which will typically provide adequate pavement surface drainage. ~~Use flatter grades of 0.3 percent if pavement is adequately sloped and supported by a firm subgrade.~~ In cases where the minimum 0.5<sup>3</sup> percent grade cannot be met, coordinate with a hydraulic designer to determine viable options to provide positive drainage. Document this coordination and final decision and include the documentation as part of the appropriate design submittal package.

Refer to GB Chapter 3 Section 3.4.2.2 for more detail on minimum grades.

### 3.5.3 Vertical Curves

Vertical curves provide a gradual change between tangent grades and may be either a crest or sag curve. Design vertical curves to allow the driver to see the roadway ahead and to provide adequate drainage. Design crest vertical curves based on stopping sight distance and sag vertical curves for headlight sight distance. The rate of vertical curvature,  $K$ , is the length of curve per percent algebraic difference in the intersecting grades.

Refer to GB Chapter 3 Tables 3-35 and 3-37 for  $K$  values for crest and sag curves.

Refer to GB Chapter 3 Section 3.4.6 for more detail on vertical alignments.

### 3.5.4 Design Controls for Vertical Curves

Refer to GB Chapter 3 Section 3.4 for more detail on design controls of vertical curves.

Refer to GB Chapter 3 Section 3.4.6.2 Table 3-35 for more detail on design controls for crest vertical curves based on stopping sight distance.

Refer to GB Chapter 3 Section 3.4.6.3 Table 3-37 for more detail on design controls for sag vertical curves.

### 3.5.5 Climbing Lanes

A climbing lane is the response to the increasing amount of traffic delays and the number of serious crashes occurring on uphill grades due to heavy loaded and slow-moving vehicles that could impede following vehicles. Consider the need for climbing lanes during the original construction planning stage and on safety improvement projects. Two-lane roads create the greatest need for climbing lanes based on limited passing opportunities but can be considered on multilane facilities. The decision to provide a climbing lane will be based on discussions with the project team.

Refer to GB Chapter 3 Section 3.4.3 for more detail on climbing lanes.

Use report *FHWA-IP-88-015 Grade Severity Rating System (GSRS)* to determine the maximum safe descent speeds for trucks according to weight and to determine the need for an auxiliary lane.

Discuss proposed climbing lane locations with the Roadway Design Unit, NCDOT Project Manager and the Division Engineer. Justification studies and cost estimates are required when climbing lanes are proposed.

### 3.5.6 Emergency Escape Ramps

Use emergency escape ramps (EER) on long mountainous grades in rural areas. Consider their use also in urban areas on steep, short grades where high truck volumes are mixed with dense traffic and development. Urban areas have a higher probability of fatalities or property damage than the rural areas especially if a stop condition or turn occurs at the end-of-grade.

It is recommended a brake-check area be provided at the top of the grade for truckers to inspect their equipment, check their brakes, read any information available about the upcoming grade and prepare for the downgrade.

Justification for an EER involves several considerations that have not been formalized into specific warrants or processes. The principal factor for an EER need is determined by runaway accident experience. Site conditions such as grade length, percent of grade, horizontal alignment, and end-of-grade conditions should all be considered. The decision to provide an EER will be based on discussions with the project team.

Average daily traffic and percentage of trucks count about the same as site conditions. Although available right of way and topography are factors in site selection, they are not factors in determining the need for a ramp.

The GSRS was developed to determine the maximum safe speed for vehicles of different weights. It can also be used to establish the need and location for truck escape ramps by calculating the brake temperatures at 0.5-mile intervals on a grade.

A very informative TRB Research Report regarding truck escape ramps is available in the Roadway Design Unit library: [NCHRP Synthesis 178 Truck Escape Ramps A Synthesis of Highway Practice](#)

Refer to GB Chapter 3 Section 3.4.5 for more detail on emergency escape ramps

### 3.5.7 Pedestrian Considerations

Design crosswalks for accessibility for pedestrians with disabilities. At crosswalk locations, the roadway grade will become the pavement cross slope along the crosswalk. Similarly, the superelevation of the roadway will become the grade of the crosswalk. Take both of these into account when establishing grades and superelevation through an intersection.



Refer to GB Chapter 3 Section 3.4.2.2.3 and [NCDOT Complete Streets](#) for more detail on pedestrian considerations

Refer to [2010 ADA Standards for Accessible Design](#) for more information on design for pedestrians with disabilities.

Refer to RDM Part I Chapter 4 Section 4.14.3 for more detail on curb ramps.

Refer to RDM Part I Chapter 8 Section 8.11.3 for more detail on intersection design considerations.

This page intentionally left blank.

# Chapter 4 Cross Section Elements

## 4.1 General

The main elements that make up the cross section of a highway or street are the roadway and the border area. The roadway is for vehicular use and consists of the traveled way, shoulders (paved and unpaved), on-street parking, and bike lanes. The border area is the area between the roadway and the right of way line and consists of fill slopes, ditches, sidewalks, shared-use paths, and berms. Border areas can also accommodate utilities landscaping features, and stormwater control measures.

Refer to GB Chapter 4 Section 4.1 for additional guidance.

## 4.2 Traveled Way

Traveled way is defined as the portion of the road that allows movement for through traffic. It does not include shoulders, curb, turn lanes, bike and pedestrian facilities, or parking lanes.

Elements that affect the design of the traveled way are surface type, cross slope, skid resistance, and hydroplaning.

Refer to RDM Part I Chapter 3 Section 3.3.3 for information on traveled way widths.

Refer to RDM Part I Chapter 7 Section 7.7 for more information on hydroplaning.

Refer to GB Chapter 4 Section 4.2 for more detail on traveled way general considerations.

Refer to GB Chapter 4 Section 4.2.3 for more detail on skid resistance.

## 4.3 Lane Widths

Lane width influences operational characteristics, level of service, driver comfort, and likelihood of crashes of a roadway.

- On local roads, use lane widths of 10 to 11 feet in residential areas and 12 feet in industrial areas. When right of way is limited, 9-foot lanes in residential areas and 11-foot lanes in industrial areas can be considered.
- For collectors, lane widths can range from 10 feet to 12 feet. In industrial areas, use 12-foot lanes unless right of way restrictions exist; in these cases, 11-foot lanes can be used. Turn lanes at intersections can vary from 10 to 12 feet depending on truck volumes.
- Lane widths for arterials range from 10 to 12 feet. On high speed, free flowing urban arterials, 12-foot lanes are preferred. When truck and bus traffic is low and speed is less than 35 mph, 10-foot lane widths may be used. Lane widths for divided arterials in a rural area should be 12 feet due to high speed and traffic volumes. On reconstructed arterials, 11-foot lanes are acceptable if the alignment is acceptable and has no crash history that would indicated widening is necessary.
- Provide 12-foot lanes on freeways and other high speed, high volume roadways.

A project may require lanes of unequal widths to be used. Locate the wider lane on the outside (right) to provide more space for larger vehicles that typically use the outside lane as well as provide space to share with bicycles. Locate the wider lane adjacent to the curb and gutter where curb and gutter is used.

Curb and gutter is typically used in urban settings as well as on four-lane median divided facilities to improve traffic operations and increase safety. At times, curb and gutter can be used for a multilane undivided facility or in areas to direct stormwater.

A five-lane curb and gutter section is not a preferred typical section to be used. If conditions suggest a five-lane curb and gutter section should be used, the preferred section is 64 feet face to face. Use the recommended minimum lane width of 15 feet providing a 34-foot face to face typical width for a two-lane two-way application.

Refer to RDM Part I Chapter 2 Sections 2.7.2 and 2.7.3 for additional guidance on lane widths.

Refer to RDM Part I Chapter 3 Section 3.3.3 for information on traveled way widths.

Refer to RDM Part I Chapter 9 Section 9.4.2.1 for additional guidance on ramp lane widths.

Refer to GB Chapter 4 Section 4.3 for more detail on lane width general considerations.

Refer to GB Chapters 5 through 8 for guidance on lane widths for specific roadway types.

## 4.4 Shoulders

The shoulder is a portion of the roadway adjacent to the traveled way that accommodates stopped vehicles, emergency use/vehicles, lateral support of pavement courses, and in some cases, bicyclists. Shoulders provide a vehicle recovery area that allows a driver to correct should their vehicle move outside the travel lane. The usable shoulder width refers to the width the driver can actually use when parking or making an emergency stop.

Pave shoulders the full width or partial width depending on the roadway classification, traffic volumes, and native soil types as recommended in the Pavement Design.

Consider bicyclists when designing paved shoulders on a roadway; the addition or improvement of these shoulders drastically improves the bicyclists' experience. Refer to AASHTO *Guide for the Development of Bicycle Facilities* (2012) 4th Edition Chapter 4 Section 5 for in depth guidance.

The graded shoulder is the width from the edge of travel way to the hinge point (shoulder slope intersects the fill/ditch front slope). When guardrail is required on a project, additional shoulder width is needed for guardrail installation and clearance. At times, this added shoulder width may be continued throughout the project for uniformity. The decision to provide this wider shoulder width is based on discussions with the project team. As a cost-reduction measure, normal shoulder widths are specified where guardrail is not required and then transitioned to wider shoulders where guardrail is required. Use engineering judgement with this method by considering the length of the project and the amount of guardrail required.

Refer to GB Chapter 4 Section 4.4 for additional guidance on shoulders.

### 4.4.1 Shoulder Widths

#### 4.4.1.1 Outside Shoulder Widths

##### Locals and Collectors

In the design of locals and collectors, use normal shoulder widths as shown in Table 4-1.

**Table 4-1 Normal Shoulder Widths for Locals and Collectors**

ADT	Design Year		
	Under 400	400–2000	Over 2000
Locals	2 feet*	3 feet*	6 feet
Collectors	2 feet*	4 feet	6 feet

Notes:

- \*When guardrail is warranted, the minimum offset from the edge of the travel way to the face of the guardrail is 4 feet.
- Any deviations from the values shown in this table should be discussed and approved by the project team.

When guardrail is warranted, the total shoulder width is increased by 3 feet, as shown in Figure 4-1

**Figure 4-1 Normal and Total Shoulder Width for Locals and Collectors**

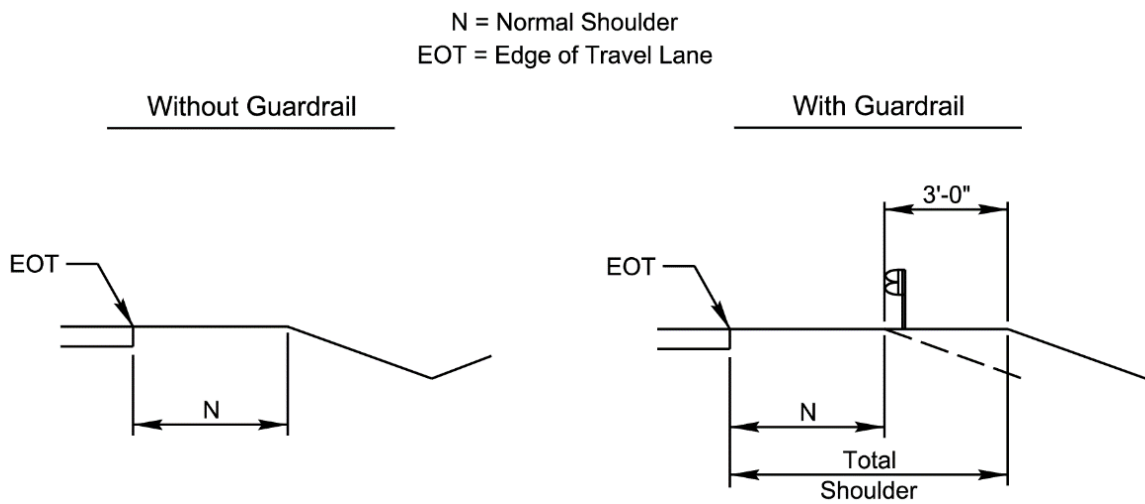

### Arterials, Interstates, and Freeways

In the design of arterials, interstates, and freeways, use minimum normal shoulder widths, as shown in Table 4-2.

**Table 4-2 Normal Shoulder Widths for Arterials, Interstates, and Freeways**

ADT	Design Year		
	Under 400	400–2000	Over 2000
Arterials	4 feet	6 feet	8 feet*

Notes:

- \*10-foot normal shoulder on freeways, expressways, and interstates; 12-foot normal shoulder on freeways and interstates when truck directional design hourly volumes (DDHV) exceed 250.
- Any deviations from the values shown in this table should be discussed and approved by the project team.

It is desirable to provide a graded shoulder that will allow vertical elements like roadside barriers and walls to be offset a minimum of 2 feet from the outer edge of the usable-normal shoulder. When guardrail is warranted, increase the total shoulder width by 5 feet as shown in Figure 4-2.

Figure 4-2 Normal and Total Shoulder Width for Arterials, Interstates, and Freeways

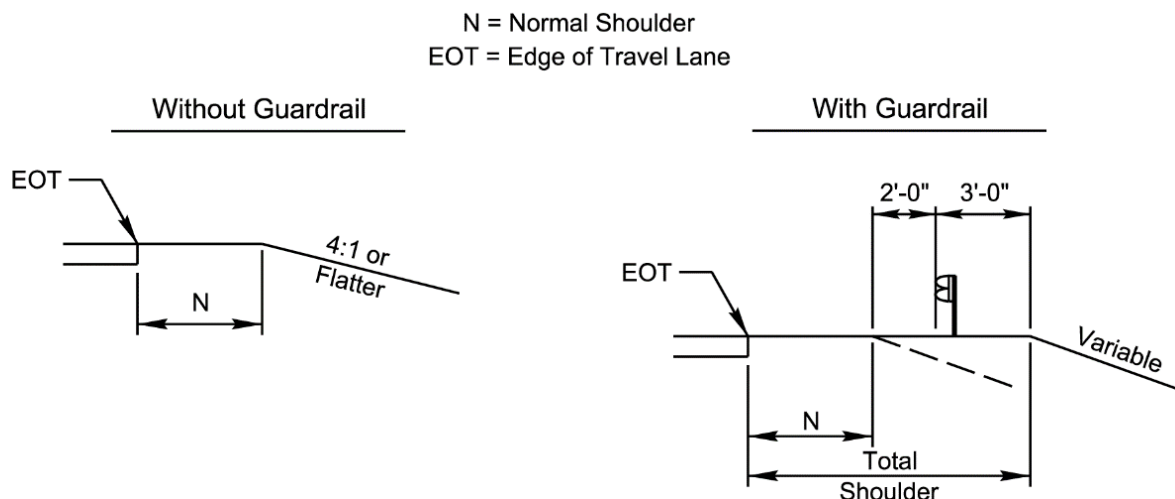

#### 4.4.1.2 Median Shoulder Widths

On facilities with medians, use median shoulder widths as shown in Table 4-3.

Table 4-3 Median Shoulder Widths

Median Width (feet)	Median Shoulder Width (feet)
75	12
60	10
46/51	6
30-36	6

#### 4.4.2 Shoulder Width on Loops

Inside shoulder – Use 2-foot 6-inch curb and gutter with 10-foot berm (right side of traffic)

Outside shoulder – Use 12-foot desirable, 10-foot minimum (left side of traffic)

#### 4.4.3 Shoulder Width on Ramps

Inside/median shoulder – Use 12-foot desirable, 10-foot minimum (left side of traffic)

Outside shoulder – Use 14-foot desirable, 12-foot minimum (right side of traffic)

#### 4.4.4 NCDOT Paved Shoulder Guidance

The NCDOT paved shoulder guidance (see Table 4-4) incorporates the findings of an in-depth study of construction, maintenance, safety, operational, and economic issues related directly to the usage of paved shoulders. The economics of providing a safe overall highway system were also considered in determining an appropriate level of expenditure for this design feature. This guidance is a standardized method developed specifically for the purpose of consistently providing acceptable paved shoulder designs for each roadway classification.

For design inclusive of bus priority treatments, refer to TRB Transit Cooperative Research Program *Report 151: A Guide for Implementing Bus on Shoulder (BOS) Systems*.

The Materials and Tests Unit – Pavement Design and Analysis Group determines the pavement design for the paved shoulder on a project-by-project basis. Usage of paved shoulder widths in excess of the requirements of this guidance must be approved by the project team.

**Table 4-4 NCDOT Paved Shoulder Guidance**

Classification	Inside/Median	Outside
Interstate and Freeways 6 or more lanes	10'	10'
Interstate and Freeways 4 lanes	4'	10'
Freeways 4 lanes ADT < 15,000	4'	4'
Median Divided Arterials and Collectors 6 or more lanes	4'	10'
Median Divided Arterials and Collectors 4 lanes ADT ≥ 40,000	4'	10'
Median Divided Arterials and Collectors 4 lanes ADT < 40,000	2'	4'
Multilane Undivided 4 or more lanes ADT ≥ 40,000	N/A	10'
Multilane Undivided 4 or more lanes ADT < 40,000	N/A	4'
Two Lane - Two Way ADT ≥ 8,000	N/A	4'
Two Lane - Two Way ADT ≥ 4,000	N/A	2'
Two Lane - Two Way ADT < 4,000	N/A	N/A
Ramps	4'	4'
Flyovers	4'	10'
Loops	N/A	4'

Notes:

1. Consider a 12-foot-wide paved outside shoulder for freeways and interstates having truck traffic which exceeds 250 directional design hour volume (DDHV). Consider a 12-foot-wide paved median shoulder for these facilities which have six or more lanes and truck traffic exceeding 250 DDHV.
2. Design 12-foot full depth paved shoulders for freeways and interstates that warrant 12-foot paved shoulders due to heavy truck traffic and design year average daily traffic (ADT) > 40,000. The pavement design for median and outside paved shoulders will be as directed by the Materials and Tests Unit – Pavement Design and Analysis Group.
3. Use rumble strips, pavement texturing or other approved methods for delineating mainline pavement surfaces from shoulder pavement surfaces on rural interstate and freeway shoulder surfaces.
4. Consider 10-foot paved inside shoulders for speeds ≥ 55 mph.
5. Consider additional width for outside paved shoulders on individual ramps if a history of excessive shoulder usage is apparent or expected based upon experience at similar facilities in the region. Discuss the need for additional paved shoulder width on ramps at the Field Inspection. The project team will approve any requests for additional paved shoulder widths on ramps. The

pavement design for the paved shoulders will be as directed by the Materials and Tests Unit – Pavement Design and Analysis Group.

6. For auxiliary lanes, pave the full usable shoulder width if the auxiliary lane connects interchanges or is longer than 2,500 feet. The pavement design for the paved shoulders on auxiliary lanes will be as directed by the Materials and Tests Unit – Pavement Design and Analysis Group.
7. Partial depth paved shoulders can be considered as a cost reduction measure if approved by the Materials and Tests Unit – Pavement Design and Analysis Group
8. At locations where the bridge offsets on directional ramps (flyovers) have been switched to accommodate horizontal sight distance, adjustments should also be made to the corresponding paved shoulders.

When utilizing a paved shoulder, a minimum 2-foot turf shoulder is required beyond the paved shoulder limit and may affect total shoulder width. In areas where guardrail is warranted, the additional 3-foot to 5-foot shoulder widths noted above include the 2-foot minimum turf shoulder.

Refer to RDM Part I Chapter 2 Section 2.7 Figure 2-3 and Figure 2-4 for guidance on pavement edge construction with paved shoulders.

#### 4.4.5 Shoulder Slopes

Shoulders can be paved or turf. For turf shoulders, the maximum cross slope is 8 percent. For 2-foot to 4-foot paved shoulders, the shoulder cross slope will be the same as the traveled way cross slope. For paved shoulders greater than 4 feet, the cross slope will be 4 percent. The maximum rollover (algebraic difference) between the travel lane and shoulder is 6 percent.

Refer to [NCDOT Roadway Standard Drawings](#), Std. Nos. 560.01 and 560.02 for shoulder slopes.

Refer to Figure 4-3 below for illustration of typical shoulder cross slopes.



Figure 4-3 Typical Shoulder Cross Slopes

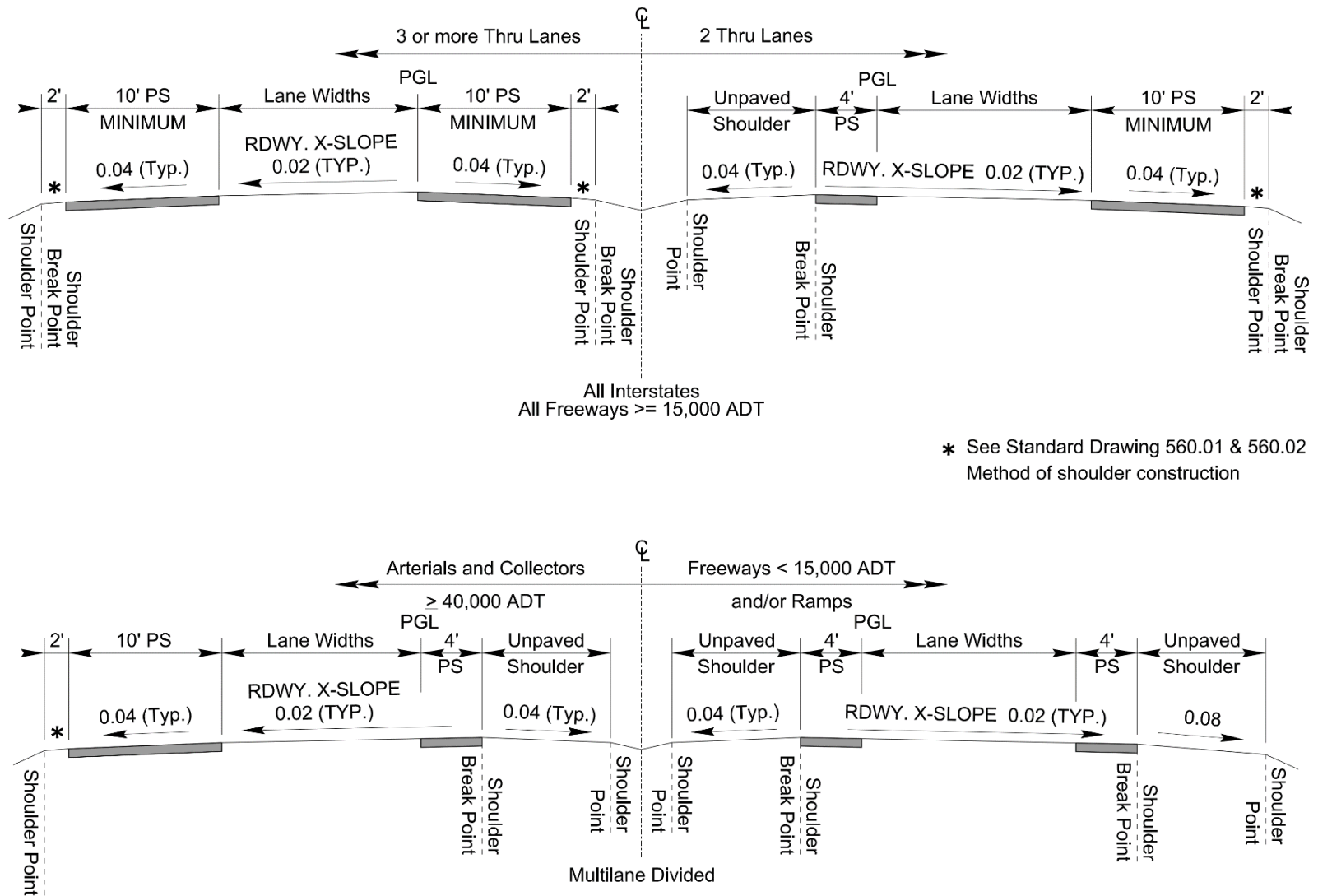
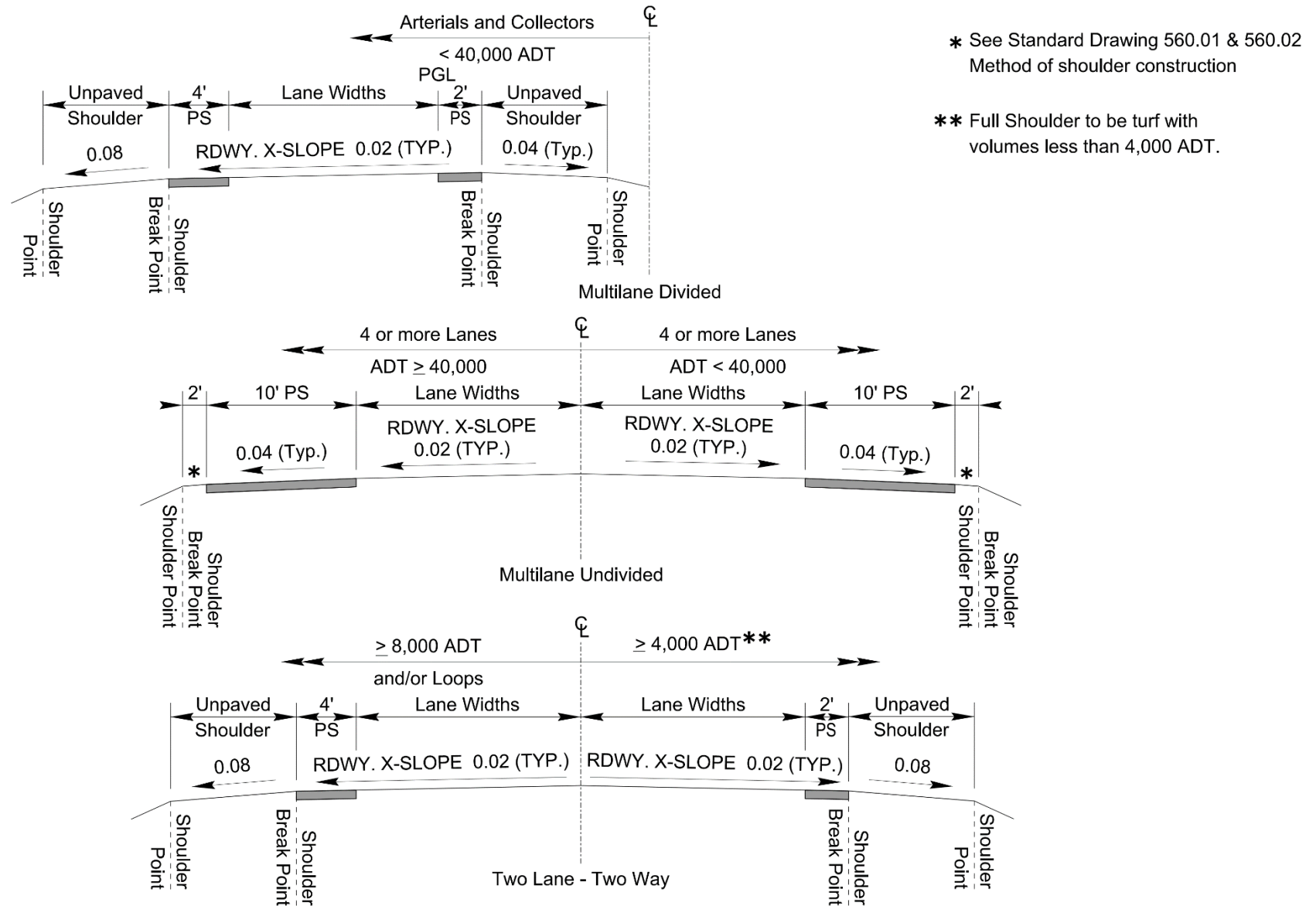

Figure 4-3 Typical Shoulder Cross Slopes (cont.)



### 4.4.6 Sideslopes

The front slope (foreslope) is the slope from the far edge of shoulder to the ditch point. Design front ditch slopes in accordance with Figure 4-4.

The back slope is the slope from the ditch bottom to existing ground and is also known as cut slope. The back slope may be a fixed slope or a hinge point slope. When fixed back slopes are used, design in accordance with the figure below. On minor or local roads, use one set of fixed slopes in cuts and fills for the length of the project.

Coordinate with the hydraulics engineer to determine the appropriate ditch side slopes based on capacity calculated in the hydraulic/hydrologic analysis.

**Figure 4-4 Criteria for Roadway Typical Section and Slopes**

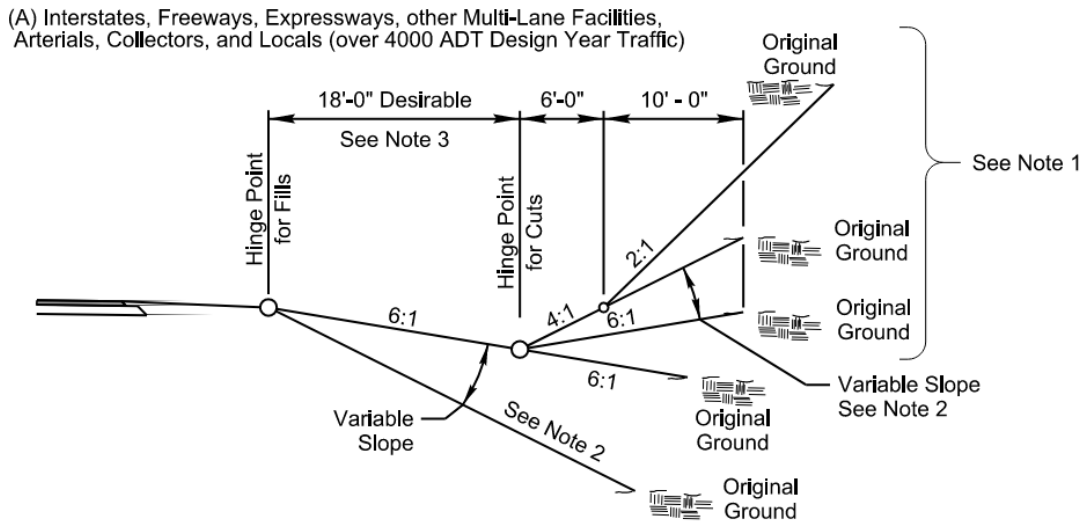

(B) Collectors and Locals (4000 ADT or less Design Year Traffic)

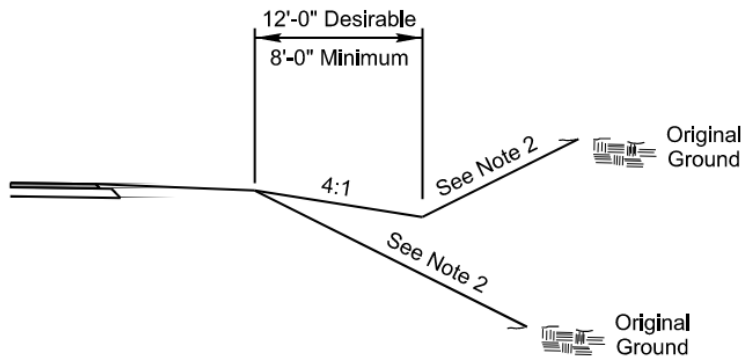

**Notes:**

1. Utilize a 6:1 backslope if you can tie into original ground within 16 feet of Hinge Point for Cuts. If limits of 6:1 backslope exceed 16 feet, transition to 4:1 backslope to stay within 16 feet of Hinge Point for Cuts. Otherwise, utilize a 2:1 backslope once beyond 6 feet of Hinge Point for Cuts.
2. The steepest practical slopes as determined by the Geotechnical Unit should be utilized. Unless otherwise noted, slopes for projects east of I-95 or in Division 4 should not be steeper than 3:1. Interstate side slopes should not be steeper than 2:1 except in rock excavation. Freeways and expressways should not be steeper than 1 1/2:1 to 2:1
3. 15'-0" minimum for Interstate, freeways, expressways, and other multi-lane facilities. 12'-0" minimum for arterials, collectors, and locals over 4,000 ADT.
4. A guardrail study will be required for fill slopes steeper than 3:1. Refer to RDM Part I Chapter 6.
5. Two-foot minimum ditch depth is required to cover driveway pipe.

The primary advantage of hinge point slopes is to provide a variable slope that relates to the height of cut or fill. Also, with the utilization of variable slopes, the proposed improvements may be blended into the existing topography and provide a more pleasing appearance. Use hinge point slopes on all freeways, expressways, and interstates in all terrains except where special ditches are required, soil conditions dictate otherwise, or rock is encountered. Hinge point slopes are also used on arterials, collectors, and locals (more than 4,000 average daily traffic (ADT) design year).

Hinge points for interstates, freeways, and expressways provide a transition area at the beginning and end of cuts and fills. Utilize steeper fixed slopes, as determined by the soils and foundation section, through the remainder of the cut or fill.

Refer to GB Chapter 4 Section 4.8.4 for more detail on sideslopes.

#### 4.4.7 Rumble Strips

Rumble strips are sensory warning treatments constructed along paved shoulders to alert the motorists before they leave the roadway and strike a roadside barrier or hazard. They alert drivers of drifting off the road by creating an audible and vibratory warning that their vehicle is leaving the designated travel lane and that a steering correction is required.

It is the responsibility of the project design team, the Division, the State Roadway Design Engineer, the State Traffic Engineer, and the Chief Engineer of Operations to ensure that the following guidelines are followed and applied consistently within their respective area of operation.

In general, use rumble strips on both the median and outside shoulder at locations on interstates, freeways, and expressways. It is not necessary to use the same type of rumble strips on the median and outside shoulders. Investigate the placement of rumble strips on existing roadways to verify the shoulder width and pavement structure are sufficient.

It will be the standard practice of NCDOT to consider rumble strips/stripes at locations on partially, limited, or non-controlled facilities that have a documented pattern of treatable lane departure events based on an engineering study and investigation.

Refer to the [NCDOT Rumble Strip Standard Practice document for non-full-controlled facilities](#).

Refer to AASHTO *Guide for the Development of Bicycle Facilities* (2012) 4th Edition Chapter 4 Section 4.5.2 for more detailed information on designing for rumble strips on roadways with bicycle facilities. Milled rumble strips are not recommended on structures.

##### 4.4.7.1 Rumble Strip Placement

###### Asphalt Paved Shoulders

Locate rumble strips in accordance with [NCDOT Roadway Standard Drawings](#), Std. Nos. 665.01 and 665.02.

###### Concrete Paved Shoulders:

Locate rumble strips in accordance with [NCDOT Roadway Standard Drawings](#), Std. Nos. 720.01 and 720.02.

###### Other Roadway Facilities

Consider use of rumble strips where documented histories of lane departure type crashes exist.

For rural median divided facilities with partial control of access (where designated driveway and street access points are allowed), consider use of rumble strips on a case-by-case basis.

The roadway designer is responsible for design and placement of rumble strips on other roadway facilities:

- The width of shoulder rumble strips may vary depending on the width of the paved shoulder provided.
- The width and placement of centerline rumble strips may vary depending on lane width and pavement marking type and use.

#### 4.4.7.2 Surface Treatment

For projects that are set up for future widening, existing rumble strips can be filled with epoxy fillers until the next scheduled pavement overlay. Existing rumble strips can also be milled before applying a new pavement surface. In cases where milled rumble strips are not practical, install raised rumble strips which include side-by-side raised pavement markers, rumble bars, or plastic inserts within thermoplastic pavement markings.

Other surface treatments may be used with the approval of the State Roadway Design Engineer and the State Traffic Engineer. The roadway designer, Transportation Mobility and Safety Unit, and the appropriate Division office will agree upon the type and extent of shoulder surface treatments, when applicable. These guidelines are not intended to restrict or prohibit the use of any alternative surface treatment when special engineering circumstances are required. When selecting the type of treatment, consider the potential use of the shoulder by traffic during future construction and maintenance operations.

These guidelines or the rumble strip standard drawings do not account for all possible applications. Therefore, it may be necessary for the roadway designer to develop special application plans or details for the application of milled-in/stamped-in or alternative longitudinal rumble strip treatments. Submit all such plans and details for review by the Transportation Mobility and Safety Unit prior to use on a project.

Refer to GB Chapter 4 Section 4.5 and FHWA site [General Information - Safety | Federal Highway Administration](#) for more detail on rumble strips.

Refer to [NCDOT Roadway Standard Drawings](#), Std. No. 665.01 for placement of rumble strips in asphalt paved shoulders.

Refer to [NCDOT Roadway Standard Drawings](#), Std. No. 720.01 for placement of rumble strips in concrete paved shoulders.

## 4.5 Traffic Management Plan and Work Zone Traffic Control

In the design of a project, the maintenance of traffic is an essential element in determining a method for maintaining a safe flow of traffic through a construction zone, determining the need for on-site detours, or directing traffic to alternate routes.

NCDOT TIP projects range in complexity and the maintenance of traffic plan encompassing motorists, pedestrians, and cyclists will be unique to each project. Coordinate with the Transportation Mobility and Safety Unit early in the design process. The team will evaluate the project characteristics to determine project/work zone level of significance:

- Category and project type

- Existing volumes and traffic lanes
- Total truck traffic (dual & tractor trailer semi-truck combined)
- US or NC route
- Project length
- Duration

The development for the project maintenance of traffic plan begins during PDN Project Initiation (Stage 1) and is further developed during the PDN Alignment Defined (Stage 2). The roadway designer should work closely with the Work Zone Traffic Control Project Engineer to develop the conceptual temporary traffic control plans to demonstrate how traffic (motorists, pedestrians, and cyclists) is to be safely maintained during construction based on the project characteristics list above.

Additionally, the roadway designer will coordinate with the hydraulic designer to determine the need for temporary drainage, construction phasing of hydraulic design elements and avoid critical safety issues including hydraulic spread.

The coordinated efforts noted above will result in establishing the proposed design criteria for on-site detours, temporary alignments or median crossovers. This design criteria will include, but is not limited to:

- Design speed/posted speed
- Number of lanes required
- Lane width
- Total shoulder and paved shoulder widths
- Bicycle and/or pedestrian accommodations
- Maximum rate of superelevation
- Detailed ditch information

Refer to [NCDOT Work Zone Traffic Control Design Manual](#) and [NCDOT Maintenance/Utility Traffic Control Guidelines](#) for more detail.

Refer to the 2018 [NCDOT Temporary Pedestrian Accommodations Guide](#) for more detail on accommodations for pedestrians and bicyclists.

## 4.6 Roadside Design

It is documented that a significant number of highway fatalities involved vehicles that left the roadway and collided with fixed obstacles. Trees, utility poles, and traffic barriers are the most common fixed objects struck that resulted in fatalities. There are many reasons a vehicle may leave the roadway including fatigue, distraction, speed, and weather conditions. Therefore, it is important to provide safeguards in roadside design to reduce or eliminate hazards that could cause serious injury or death should a vehicle leave the roadway. Consider the following options to reduce roadside obstacles during design:

- Remove obstacle
- Redesign obstacle to be safely traversed
- Relocate obstacle

- Reduce impact severity with a breakaway device
- Shield obstacle with barrier that will redirect vehicle or use crash cushion
- Delineate obstacle if other options are not appropriate

Refer to GB Chapter 4 Section 4.6 and RDG Chapter 1 Section 1.2 for more information on roadside design.

Refer to RDM Part I Chapter 6 for additional information regarding the use roadside barriers to shield obstacles.

There are two main considerations for design elements outside of the through traveled way: clear zone and lateral (horizontal) offset.

### 4.6.1 Clear Zones

The unobstructed traversable area provided beyond the edge of the traveled way is termed the clear zone. This area is used for the recovery of errant vehicles and includes shoulders, bike lanes, and auxiliary lanes. The desired minimum width is dependent upon traffic volumes, speeds, and roadside geometry. Use a reduced clear zone width in urban areas when right of way constraints may prohibit a full-width clear zone.

Refer to GB Chapter 4 Section 4.6.1 and RDG Sections 3.1, 3.3, and Figure 3-2 for more information on clear zones.

Table 3-1 (U.S. Customary Units) from RDG Section 3.1 is reprinted below as Table 4-5.

Table 4-5 Suggested Clear-Zone Distances from Edge of Through Traveled Lane

Design Speed (mph)	Design ADT	Foreslopes			Backslopes		
		1V:6H or flatter	1V:5H to 1V:4H	1V:3H	1V:3H	1V:5H to 1V:4H	1V:6H or flatter
≤ 40	Under 750 <sup>c</sup>	7 - 10	7 - 10	See Note b	7 - 10	7 - 10	7 - 10
	750 - 1500	10 - 12	12 - 14		10 - 12	10 - 12	10 - 12
	1500 - 6000	12 - 14	14 - 16		12 - 14	12 - 14	12 - 14
	Over 6000	14 - 16	16 - 18		14 - 16	14 - 16	14 - 16
45 - 50	Under 750 <sup>c</sup>	10 - 12	12 - 14	See Note b	8 - 10	8 - 10	10 - 12
	750 - 1500	14 - 16	16 - 20		10 - 12	12 - 14	14 - 16
	1500 - 6000	16 - 18	20 - 26		12 - 14	14 - 16	16 - 18
	Over 6000	20 - 22	24 - 28		14 - 16	18 - 20	20 - 22
55	Under 750 <sup>c</sup>	12 - 14	14 - 18	See Note b	8 - 10	10 - 12	10 - 12
	750 - 1500	16 - 18	20 - 24		10 - 12	14 - 16	16 - 18
	1500 - 6000	20 - 22	24 - 30		14 - 16	16 - 18	20 - 22
	Over 6000	22 - 24	26 - 32 <sup>a</sup>		16 - 18	20 - 22	22 - 24
60	Under 750 <sup>c</sup>	16 - 18	20 - 24	See Note b	10 - 12	12 - 14	14 - 16
	750 - 1500	20 - 24	26 - 32 <sup>a</sup>		12 - 14	16 - 18	20 - 22
	1500 - 6000	26 - 30	32 - 40 <sup>a</sup>		14 - 18	18 - 22	24 - 26
	Over 6000	30 - 32 <sup>a</sup>	36 - 44 <sup>a</sup>		20 - 22	24 - 26	26 - 28
65 - 70 <sup>d</sup>	Under 750 <sup>c</sup>	18 - 20	20 - 26	See Note b	10 - 12	14 - 16	14 - 16
	750 - 1500	24 - 26	28 - 36 <sup>a</sup>		12 - 16	18 - 20	20 - 22
	1500 - 6000	28 - 32 <sup>a</sup>	34 - 42 <sup>a</sup>		16 - 20	22 - 24	26 - 28
	Over 6000	30 - 34 <sup>a</sup>	38 - 46 <sup>a</sup>		22 - 24	26 - 30	28 - 30

## Notes:

- When a site-specific investigation indicates a high probability of continuing crashes or when such occurrences are indicated by crash history, the designer may provide clear-zone distances greater than the clear zone shown in Table 4-5. Clear zones may be limited to 30 feet for practicality and to provide a consistent roadway template if previous experience with similar projects or designs indicates satisfactory performance.
- Because recovery is less likely on the unshielded, traversable 1V:3H fill slopes, fixed objects should not be present in the vicinity of the toe of these slopes. Recovery of high-speed vehicles that encroach beyond the edge of the shoulder may be expected to occur beyond the toe of slope. Determination of the width of the recovery area at the toe of slope should consider right of way availability, environmental concerns, economic factors, safety needs, and crash histories. Also, the distance between the edge of the through traveled lane and the beginning of the 1V:3H slope should influence the recovery area provided at the toe of slope. While the application may be limited by several factors, the foreslope parameters that may enter into determining a maximum desirable recovery area are illustrated in Figure 4-5. A 10-foot recovery area at the toe of slope should be provided for all traversable, non-recoverable fill slopes.
- For roadways with low volumes, it may not be practical to apply even the minimum values found in Table 4-5. Refer to RDG Chapter 12 for additional considerations for low-volume roadways and RDG Chapter 10 for additional guidance for urban applications.
- When design speeds are greater than the values provided, the designer may provide clear-zone distances greater than those shown in Table 4-5.

Source: RDG Chapter 3 Section 3.1 Table 3-1



Place above ground objects as close to the right of way line as possible and outside the clear zone as defined by the RDG.

Refer to [NCDOT Utility Accommodations Manual](#) Section 3.3 for more information on the placement of utility poles and other above ground objects within the right of way.

In curb and gutter sections, place utility poles and above ground objects outside the clear zone where the posted speed is 45 mph or less. In urban areas and other locations where constraints exist, consideration may be given to allowing the placement of breakaway structures within the clear zone. Ultimately, pole locations and pole type will be determined on a project-by-project basis.

## 4.6.2 Vehicle Recovery Areas

Vehicle recovery area is defined as a traversable clear zone adjacent to the highway travel lanes within which all fixed hazards have either been removed, reconstructed to acceptable safety criteria, or shielded. The width of a recovery area varies with design speed, traffic volumes, and slope configurations.

A traversable and recoverable clear zone indicates there are no slopes encountered within the clear zone which are steeper than 4:1. Slopes between 3:1 and 4:1 are traversable, but not recoverable. Any slopes steeper than 3:1 are classified as critical; an errant motorist will not be able to traverse or recover on these slopes.

Refer to RDG Section 3.2 and Figure 4-5 below for more detail on slopes.

Place all utility poles outside the clear zone as defined by the RDG. Refer to [NCDOT Utilities Accommodation Manual](#) Section 3.3 for additional guidance regarding above ground utilities.

Refer to RDG Chapter 3 for more detail on roadside design and vehicle recovery area.

Figure 4-5 Detail Guide for Vehicle Recovery Areas

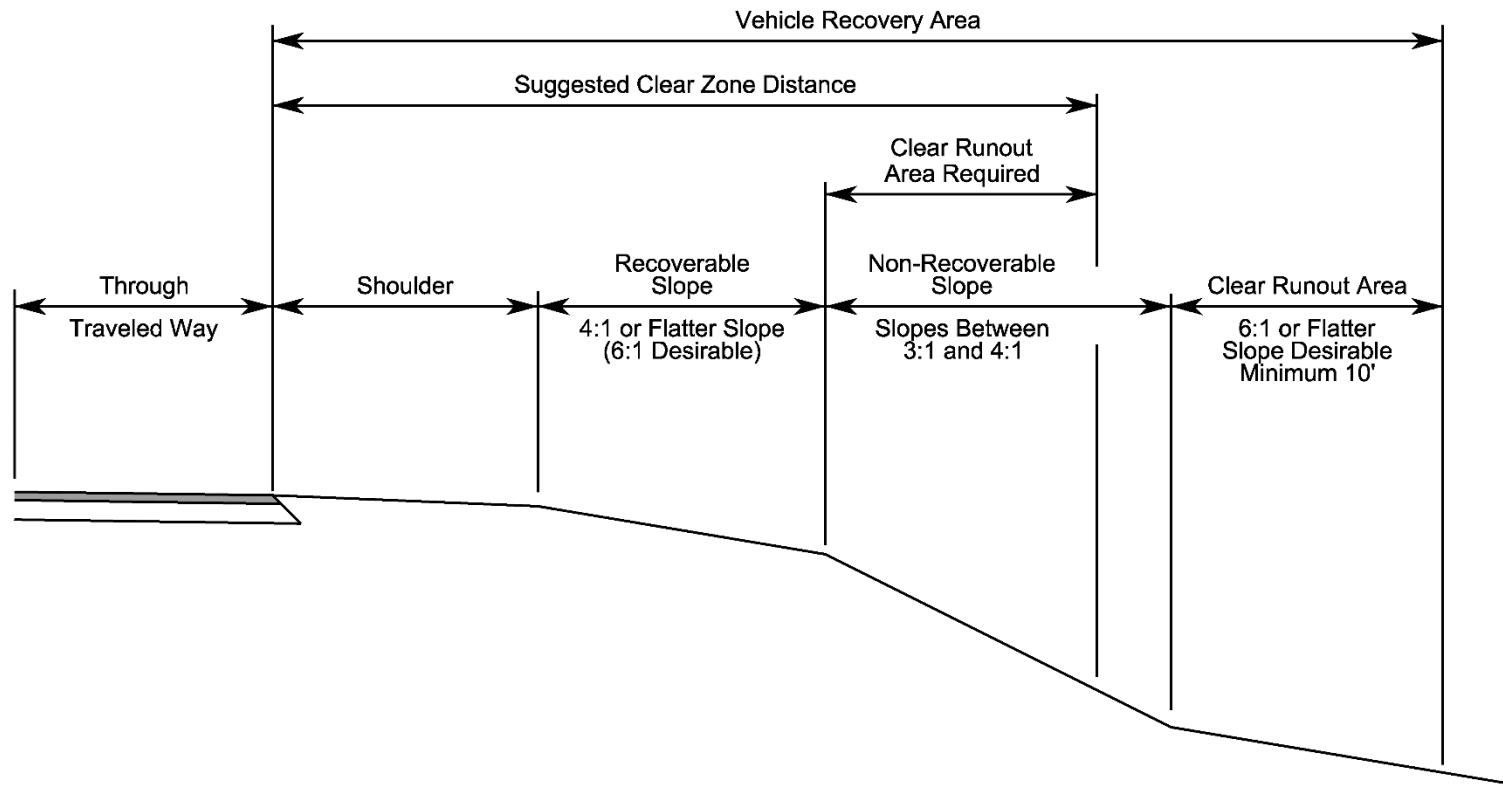

Note: Clear runout area is additional clear zone space that is needed because a portion of the suggested clear zone distance falls on a non-recoverable slope. The width of the clear runout area is equal to that portion of the clear zone distance located on the non-recoverable slope.

Source: RDG Chapter 3 Section 3.2.1 Figure 3-2

### 4.6.3 Lateral Offset

The horizontal clearance from the edge of the traveled way, shoulder or other designated point to a vertical roadside element is known as the lateral offset distance. These dimensional values are not calculated and are not intended to constitute a clear zone. They are intended to provide a roadside environment that is not likely to have an adverse effect on motorists' using the roadway. Lateral offsets provide a clearance for mirrors on trucks and buses that are in the extreme right lane of a roadway and for opening curbside doors of parked vehicles. Curbs, walls, barriers, piers, sign and signal supports, mature trees, landscaping items, and power poles are primary examples of the type of features that can affect a driver's speed or lane position if located too close to the roadway edge.

The roadway designer has a significant degree of control over roadside geometry and right of way for rural conditions and especially new rural highways. In urban settings, right of way can be very limited, and it may be impractical from a cost and impact standpoint to establish the minimum clear zone recommended in the RDG. Consider use of a lateral offset in cases that typically have lower operating speeds, on street parking and numerous fixed objects (for example: poles, fire hydrants). In locations where curb is used, lateral offset is measured from the face of curb. Provide a minimum lateral offset of 1.5 feet from the face of curb with 3 feet at intersections; the desirable lateral offset value is 4 to 6 feet.

Refer to GB Chapter 4 Section 4.6.2 and RDG Chapter 3 Section 3.4.1 and Chapter 10 Section 10.1 for more information on lateral offset.

Refer to RDM Part I Chapter 5 for detailed information regarding offsets and structure widths for structure and bridge locations.

## 4.7 Curbs

Curbs fill multiple purposes and therefore the decision to use curbs and curb and gutter should be discussed with the project team. The designer must consider the environment and type when deciding to use curb, curb and gutter, or gutter in a location as it affects driver behavior. The clear zone behind curb and lateral offset, in an urban setting, should have a minimum offset which is influenced by the roadway design speed as curbs have limited redirection capabilities. The hydraulics engineer may also recommend curb or curb and gutter for drainage purposes.

Refer to RDM Part I Chapter 7 for hydraulic considerations on the use of curbs.

Refer to GB Chapter 4 Section 4.7 and RDG Chapter 3 Section 3.4.1 and Chapter 10, Section 10.2.1.1 for more information on curbs.

Refer to [NCDOT Roadway Standard Drawings](#), Std. No. 846.01 for curb, gutter, and curb & gutter sections.

Refer to RDM Part I Chapter 6 Section 6.3.8 for guidance on use of gutter in combination with guardrail.

Refer to Figure 4-6 for berm widths showing desirable and minimum sections. Construct one of these sections if sidewalk is not constructed initially but is anticipated.

For Shared-Use Paths, Sidepaths and Greenway guidance see RDM Section 4.14.1.1

Coordinate with municipalities when sidewalk is placed at the back of curb. Sidewalk widths greater than 5 feet may be required.

Refer to RDM Part II Chapter 14 for right of way placement.

Figure 4-6 Berm Width

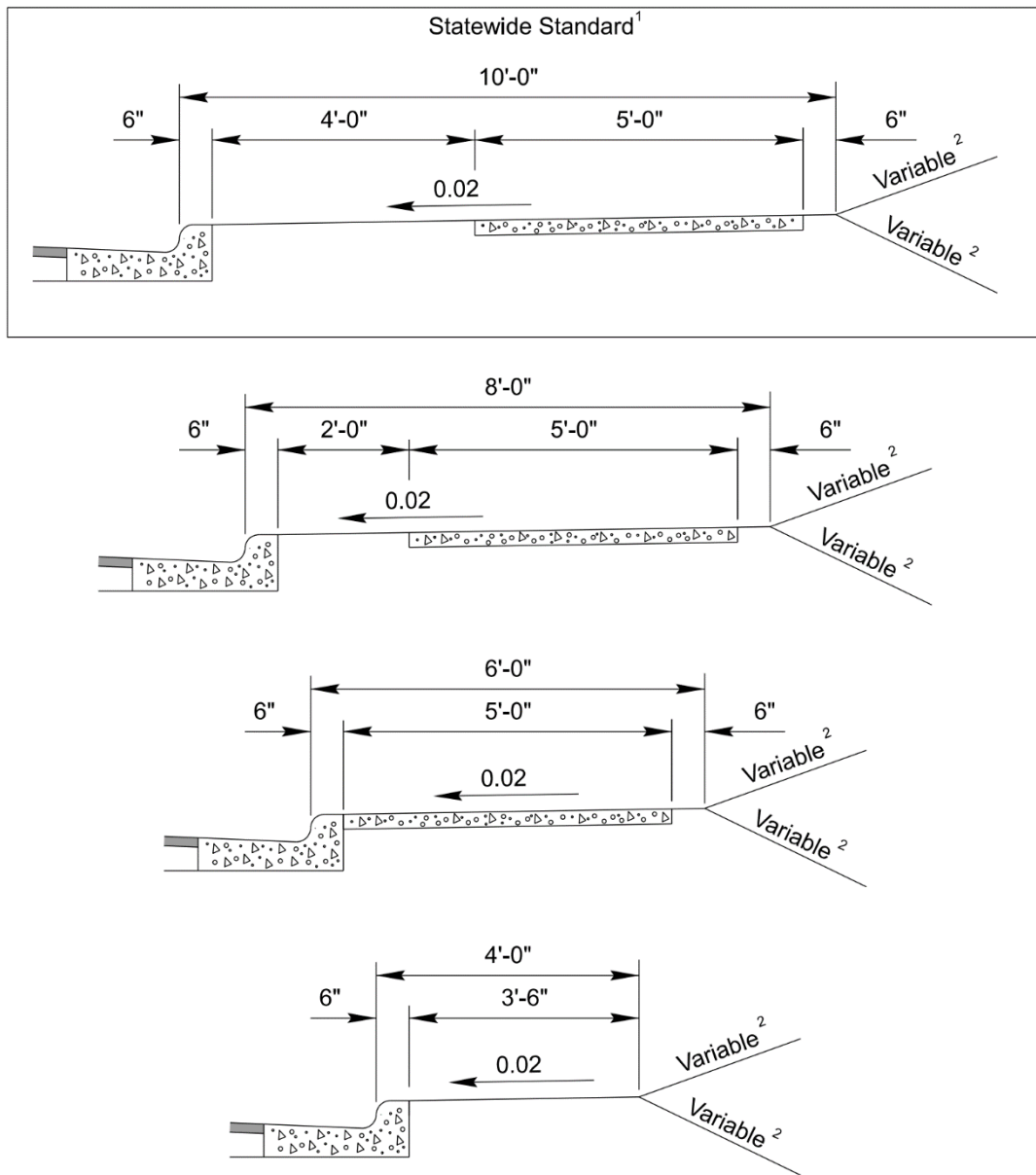

Notes:

1. Statewide Standard should be used on projects where sidewalks are proposed or being accommodated for in the future. More narrow berms may be used on projects with right of way restrictions or terrain constraints. Wider berms may be needed at guardrail locations. Refer to NCDOT Roadway Standard Drawings Std. No. 862.01.
2. Slope based on height of fill or cut as shown.

Fill or Cut Heights	Slope
0' to 5'	4:1
5' to 10'	3:1
Greater than 10'	2:1

## 4.8 Glare Screens

Glare screens are used in temporary and permanent medians to improve safety by blocking headlight glare from oncoming traffic. Design parameters for glare screens include median width, barrier type, vertical curvature, and horizontal curvature.

- Criteria for use of glare screens
  - Consider using glare screens in the median on multilane highways, in interchange areas, and where service roads are in close proximity to major arterials.
  - Use glare screens whenever possible for opposing traffic with 20 feet or less of separation.
  - Consider widths of 21 feet to 50 feet on a project-by-project basis and justify using the following criteria:
    - New facilities
      - Vertical and horizontal alignment
      - Traffic volumes
      - Field review of graded roadway
    - Existing facilities
      - Accident experience
        - Day/night ratio of accidents
        - Age of drivers in night accidents
        - Unusual distribution by type of accident
      - Day/night traffic volumes
      - Public input
      - Vertical and horizontal alignment
      - Measure of glare (Use Pritchard photometer)
  - Glare screens are not needed for traffic separated by 50 feet or more .
  - Cutoff angle for opposing highlight glare for screens on tangent alignments is twenty degrees. The cutoff angle for screens on horizontal curves is twenty degrees plus degree of curvature.
  - Consider use of glare screen should be given when transit facilities (light rail or bus rapid transit) are adjacent to roadway facilities.
  - Use engineering judgement for selection of type and height of glare screen.
- Types of glare screens:
  - Type I – A continuous screen that is opaque to light from all angles.
  - Type II – A continuous screen of an open material that is opaque to light at angles to about 20 degrees and increasingly transparent beyond 20 degrees.
  - Type III – Individual elements positioned to block light at angles from 0 degrees to 20 degrees. Beyond 20 degrees, visibility is clear between the elements.
  - The following types of glare screens are recommended:
    - Plants
    - Extended concrete barrier

- 0.5-inch mesh chain link fence (vinyl coating optional); standard height is 48 inches
- Modular guidance system

The State Roadway Design Engineer's approval is required for any use of glare screen in areas other than interchanges or in areas in the 21-foot to 50-foot width. Include drawings and justifications in the submittal.

Refer to RDG Chapter 9 Section 9.5.1 for more detail on glare screen in work zones.

Refer to [NCDOT Roadway Standard Drawings](#), Std. No. 866.05 for information on glare screens mounted on guardrails.

## 4.9 Medians

A median is a section of highway that separates opposing lanes. The separation can be paved or unpaved. The median width is the distance between the inside edge of travel way of the inside lanes of the opposing lanes. The comprehensive planning and design of typical highway cross sections provide guidance on various median widths in relation to the road type and posted speed limit. The final cross section and final median width will be developed during the preparation of the environmental documentation and final design.

- Common median widths are listed below and in Table 4-6. Median widths for interstates and freeways are as follows:
  - 75-foot Standard
  - 51-foot Minimum depressed median
    - Allows for future lanes with a 27-foot median with concrete barrier.
    - When widening for additional lanes on an existing 46-foot depressed median, a 22-foot median with concrete barrier is acceptable. A design exception may be required for median shoulder width and sight distance.
  - 27-foot Minimum for six or more lanes with concrete barrier
  - 27-foot Standard for four lanes with concrete barrier

**Table 4-6 Median Widths for Highways other than Freeways**

New Location / Reconstruction	Widening to Four Lane Divided
60' Standard	60' Desirable with ditch
51' Minimum	51' Standard with ditch
	*30' Minimum with ditch
	**23'-30' with raised median

Notes:

(\*) Do not use a 30-foot median at intersections subject to heavy school bus crossings. A 51-46-foot median is recommended at these intersections. Discuss median widths with the project team.

(\*\*) Median widths may have to be adjusted to accommodate median bridge piers.

In some cases, narrower medians will not have enough room to provide a ditch deep enough to handle water runoff. In these cases, a method of resolving this situation is called a positive drainage treatment. Positive drainage treatment is required when the ditch is less than 18 inches below the subgrade at the edge of the nearest traffic lane. Obtain the positive

drainage treatment from the Pavement Management Unit. This treatment must be a median underdrain or a minimum roadway grade of 1 percent in satisfactory drainage soils, or 1.5 percent in soils, which do not have satisfactory drainage properties. If marginal situations occur, place appropriate median drainage structures to provide adequate ditch drainage.

Refer the RDM Part I Chapter 7 Section 7.6 for additional information on median drainage.

Design special grading for medians in superelevation in accordance with [NCDOT Roadway Standard Drawings](#) Std. Nos. 560.01 and 560.02.

For arterial or collectors with curb and gutter with raised medians, consider a 23-foot or 17.5-foot median.

Use a 23-foot raised median where practical. This width accommodates median left turn lanes with a 4-foot offset for increased visibility and sight distance. A 17.5-foot minimum can be considered but does not provide adequate room for the 4-foot offset.

Refer to GB Chapter 4 Section 4.11 for additional information on medians.

### 4.9.1 Median Slopes

Design median slopes as flat as reasonable to provide safe recovery areas, while providing an adequate ditch depth for drainage of the median and pavement structure.

**Table 4-7 Recommended Maximum Median Slopes**

Median Width (feet)	Recommended (Maximum) Median Slope
75	8:1
60	8:1
46/51	6:1
30-36	5:1

In superelevated areas, the median slope may be steepened to a maximum slope of 4:1 to obtain a ditch grade that will drain. A 6:1 slope is considered acceptable for existing medians where obtaining an 8:1 slope is not feasible.

A minimum depth of 18" below the subgrade for the median ditch elevation is recommended to provide adequate drainage. Coordinate with Geotech, Hydraulics and the Pavement Design Section to devise a drainage treatment where narrower medians cannot meet the 18".

Provide a 10:1 slope or flatter in front of guardrail and a 6:1 slope or flatter for locations with median guiderail.

#### 4.9.14.9.2 Median Crossovers

A median crossover is defined as any connection of the opposing travel lanes that crosses the median of a divided highway. The crossover can be an opening for left turns, U-turns, a full intersection, or an opening for emergency vehicles.

##### 4.9.1.14.9.2.1 Median Crossover Guideline Statement

Median divided facilities provide the benefits of separating opposing travel lanes, controlling left turn conflicts, allowing a recovery area for out-of-control vehicles, and providing space for future

travel lanes. Research data also concludes that the median divided facilities improve traffic flow (travel speeds), traffic operations (reduces congestion), and traffic safety (lower crash rates), when compared to non-divided facilities. Median crossovers may be necessary on median divided facilities that are not fully access controlled to allow for additional turning and through movements.

Consider placement of crossovers carefully since crossovers introduce conflict points along a divided facility and thus may reduce the safety and capacity of the median divided facility. The following guidelines have been developed as a guide for design engineers, traffic engineers, and field personnel when considering the placement or addition of median crossovers. The median crossover guidelines shall be used for all new crossovers, even in the cases where adjacent crossovers were approved under previous guidelines.

Note: The State Traffic Safety Engineer and the Mobility and Safety Field Operations Engineers will review and approve all median crossover requests that meet Department Policies and guidelines, and all exceptions are required to be brought to the attention of the State Traffic Engineer or designee.

#### **4.9.1.24.9.2.2** Types of Crossover Design

When a crossover is deemed justified by the Department, only the crossover type that meets the operational and safety needs of the location will be considered. The type of crossover design below is listed from the most desirable to least desirable.

- Use of alternative routes and access – This level uses the existing infrastructure of streets, highways, intersections, and existing crossovers to provide the mobility a proposed crossover would serve.
- Directional Crossovers – A directional crossover provides for left turns in one direction only. These crossovers are preferred because they provide for the predominant movement and are much safer for the traveling public. This technique provides positive access control on major roadways through the design of median openings to allow only designated movements. Typically, these crossovers only provide for left turns from the major route to the side street. No left turns or straight across movements are allowed from the side street. Where the minimum spacing requirements are not met and there is a defined need for left-turn access, only a directional crossover will be considered. However, the general guidelines must be met for the directional crossover to be considered.
- Median U-turn Crossovers – Median U-turns allow a vehicle to make a U-turn and do not allow for through movement from a side street or driveway.
- Directional Crossovers with Median U-turns – The combination of these two crossover types may be used on a case-to-case basis where it is deemed desirable. Refer to RDM Part I Chapter 8 Section 8.8 for more information.
- All-Movement Crossovers – All-movement crossovers provide for all movements at the intersection or driveway. The use of all-movement crossovers is reserved for situations where there is sufficient spacing, and other crossover designs cannot adequately meet the operational needs of the location. Limit the use of this crossover design because it decreases capacity, increases delay and congestion, may increase pollutants from vehicles, and some studies indicate it may have a higher propensity for crashes.



#### 4.9.1.34.9.2.3 General Guidelines for Median Crossover Installations on New and Existing Facilities

All proposed median crossovers on existing and new facilities shall be evaluated from an operational and safety perspective. The availability of reasonable alternative routes, access points, and existing crossovers, along with the desire to preserve the capacity and safety of the facility shall be considered in all proposed crossovers.

The availability of adequate spacing for a crossover shall be considered when determining if a crossover is justified. However, the availability of adequate spacing alone does not warrant a new crossover.

A median crossover shall only be considered when the Department deems it necessary to service traffic generated by existing (and proposed) roadways, businesses, or other development; and this traffic cannot be adequately serviced with the existing crossovers at intersections, reasonable alternative routes, or other access points.

It is the requesting party's responsibility to provide the justification, or means to acquire the information for justification, for new crossovers. If this information is not provided, the crossover will not be reviewed or approved. As part of the justification, provide a Traffic Impact Analysis to be reviewed by NCDOT personnel.

When the Department has deemed a median crossover is necessary, the only crossover type considered will be that which meets the operational and safety needs of the facility.

A median crossover shall not be allowed unless an adequate length left turn deceleration lane and taper can be provided, and the addition of the crossover will not impede the storage requirements of adjacent intersections. Left turn lanes will be installed to serve all nonemergency crossover movements allowed on the divided facility at the time of installation.

When crossovers are considered, U-turn movements must be adequately accommodated or restricted. When warranted, the roadway designer will design the crossover to accommodate U-turn movements based on the design vehicle use of bulb outs may require additional widening beyond the standard roadway typical width. The sight distance analysis for the U-turn movement should consider the perception-reaction time, the time required to perform the U-turn maneuver and distance needed to reach the facility speed based on the roadway grade. Refer to Section 3.2 for more discussion on sight distance.

Median crossovers shall not be located where intersection sight distance (both vertical and horizontal) cannot meet current NCDOT design criteria.

Median crossovers shall not be placed in areas where the grade of the crossover will exceed 5 percent. Give special consideration to the vertical profile of any median crossover that has the potential for future signalization to ensure a smooth crossing from a present or future side street.

It is desirable to place median crossovers on facilities that have median widths 23 feet or greater.

Avoid crossovers that require a signal or where there is expected potential for a future signal in an otherwise unsignalized area.

The Department retains the authority to close or modify any crossover that it deems to be operationally unsafe to the traveling public.

#### 4.9.1.4.4.9.2.4 Median Crossover Guidelines for North Carolina Streets and Highways

##### Interstate and Non-Interstate Highways with Full Control of Access

No public-use median crossovers will be allowed.

U-turn median openings for use by authorized vehicles for the maintenance and policing of highway or emergency response can be allowed when an engineering study clearly indicates a need. Abide by the following guidelines for the spacing of median openings:

- U-turn median openings can be provided if a need has been determined and that they can be added in a safe location where decision sight distance is available. When adding a crossover, it should be located at least one-half mile from any overhead structure and at least one mile from the terminus of a ramp acceleration lane or a deceleration lane. The median crossover should be signed appropriately.
- The minimum spacing of adjacent U-turn median crossovers between interchanges is 3 miles. However, spacing alone is not justification for a crossover.
- On urban freeways, the interchange spacing is generally close enough that openings are not warranted. Therefore, U-turn openings are not allowed. In addition, on facilities where acceptable gaps are unlikely due to high ADTs, U-turn openings are not allowed.

##### Divided Highways without Full Control Access (Posted speeds of greater than 45 mph)

On highways with higher traveling speeds, the potential for more severe crashes is greater. Also, on high-speed facilities, development is usually not as concentrated as on lower speed facilities. In order to maximize the safety of these facilities, crossover spacing is critical.

All-movement crossovers shall not be any closer than 2,000 feet apart on divided highways. However, spacing alone is not justification for a crossover. It must be determined that a crossover addition is needed to meet the operational requirements of the facility. Where this spacing requirement is not met and there is a defined need for left-turn access, a directional crossover will be considered. However, the general guidelines must be met in order for the directional crossover to be added.

##### Divided Highways without Full Control Access (Posted speeds of 45 mph and less)

For divided highways without full control of access there are more access points along the facility, and thus there is usually more demand for median crossovers. This is usually the case on lower speed facilities. Because of the density of the development and lower traffic speeds, it is acceptable to provide a closer spacing of median crossovers. However, the availability of adequate spacing alone is not justification for a crossover. Crossovers must be justified to meet operational and access needs the existing facility cannot adequately serve. Only the type of crossover that meets the operational, access and safety needs of the facility shall be added. Directional crossovers are preferred where they meet the operational and access needs of the roadway.

The spacing of crossovers is largely dependent upon the need for adequate storage for left turning vehicles or U-turn vehicles at intersections. A crossover shall not be placed where it interferes with the storage requirement for existing intersections.

All-movement crossovers shall not be spaced any closer than 1,200 feet apart on divided highways with posted speed of 45 mph and less. Where this spacing requirement is not met and

there is a defined need for left-turn access, a directional crossover will be considered. However, the general guidelines must be met in order for the directional crossover to be added.

### Responsibility of Locating Crossovers on Active Roadway Design Projects

The roadway designer is responsible for locating the crossovers for a highway while a project is in design and during the life of the construction of the project. Only crossovers at arterials, major collectors, and major traffic generators will be shown on the hearing maps. The Division shall be consulted regarding the level of access management desired for the project.

Determine if the crossover is justified and determine the appropriate crossover design type. Priority will be given to placing median crossovers at existing intersecting streets. After the crossovers are located for existing streets that justify a crossover, examine the remainder of the highway facility, along with reasonable alternative routes and access points, to determine if there are any other major traffic generators that require consideration for a crossover. Follow the minimum spacing as outlined previously in these guidelines when considering the intermediate crossover locations, follow the minimum spacing as outlined previously in these guidelines. Show the crossover design that meets the operational, access, and safety requirements.

All crossovers are subject to the review of the Transportation Mobility and Safety, the Division, and the appropriate local officials if applicable.

Special circumstances may justify the need to deviate from these guidelines. If requests are made for crossovers that deviate from these guidelines, Transportation Mobility and Safety, and the Division will review the location of the crossover and offer recommendations. The State Traffic Engineer will be responsible for granting any exceptions to these guidelines on active design and construction projects. Prior to approval of any contractual agreements for crossovers, all negotiated crossovers must be reviewed and approved by Transportation Mobility and Safety, State Roadway Design Engineer, Division, and the appropriate local officials if applicable.

Final approval or denial of the request shall be the responsibility of the State Traffic Engineer. If any aspect of the requested median crossover deviates from the guidelines, the Transportation Mobility and Safety and the Division will confer to determine the necessary action to be taken. The State Traffic Engineer will be responsible for granting any exceptions to the guidelines on existing facilities. The State Traffic Engineer will notify the Division Engineer and the State Roadway Design Engineer of the decision reached.

### Crossovers Considered for Private Developments on Existing facilities

A private development that justifies direct access and benefits from an added median crossover will be responsible to construct or fund its installation. In addition, it is the responsibility of the requesting party to provide the justification and means to acquire the information for justification, for new crossovers. If this information is not provided, the crossover will not be reviewed or approved. The developer will be required to submit a complete set of plans and specify the exact location, design, and construction requirements for the proposed median crossover. Only the type of crossover that meets the operational and safety needs of the facility shall be added. Directional crossovers are preferred where the design meets the operational and access needs of the roadway. Approval of such a crossover is subject to a traffic engineering investigation and approval procedures as outlined in these guidelines.

Any drainage facilities required by the construction of the crossover will be installed or funded by the developer or the applicant at their expense. After the construction has been completed in

accordance with the Division of Highways requirements and standards and passes inspection by the Division, the Division of Highways will assume ownership and maintenance of the crossover.

Failure to comply with the location, design, or construction requirements will result in the crossover being barricaded or removed until the deficiencies have been corrected at the applicant's expense. Once the Division of Highways assumes the ownership, the median crossover will then be subject to the regulations exercised under the police power of the State of North Carolina.

The Department retains the authority to close or modify any crossover it deems to be operationally unsafe to the traveling public; or causes undue delay, congestion, or adverse impact to traffic operations.

### Special Use Crossovers

Median crossovers for special purposes, such as fire protection, ambulance services, etc. shall be considered on an individual basis after a traffic engineering investigation.

Emergency response plans and expected level of need, in addition to the geometric limitations of the facility will be used in consideration for special use crossovers. Approved special use crossovers shall be appropriately designed, delineated, and regulated. However, the availability of adequate spacing alone does not warrant a new crossover.

#### 4.9.24.9.3 Spread Median

A spread median may be considered on high speed, median divided facilities where comparative analysis and cost estimates indicate a spread median is economically justified. When a spread median is proposed on a project, show a typical section in the plans. If adequate sight is available, provide separate roadway sections. A 20-foot vertical curve is suggested for rounding of the intersecting slopes as shown in Figure 4-7.

In locations where a spread median is being constructed and it is proposed to leave a portion of the median undisturbed, clearly mark the areas on the plans. Clearly mark any trees to remain in place.

Figure 4-7 Grading of Spread Median

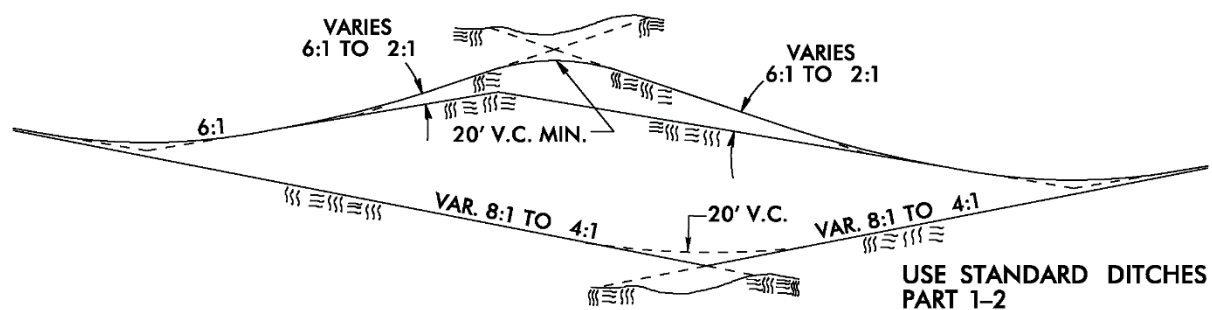

Notes:

1. Check RDG for median slope.
2. Use the same hinge point as for the outside in undisturbed medians.

## 4.10 Service Roads

A service road (also known as a frontage road or access road) is a local road that runs parallel to a higher speed, limited access facility. A service road may be used to control access to a higher type facility and to separate local traffic from the higher speed through traffic. This minimizes interference with the operations of the through traffic and provides access to adjoining properties. A service road can also be used to provide access to a property that will be landlocked by the proposed roadway project. In this case, complete a service road study to determine the efficacy of the service road. Where possible, the appropriate clear zone distance should be provided between the throughway and the service road. If the appropriate clear zone cannot be obtained, then the use of longitudinal barriers should be investigated.

Refer to GB Chapter 4 Sections 4.12 and 4.13, also Chapter 7 Section 7.3.15, Chapter 8 Section 8.2.12, and Chapter 9 Section 9.11.1 for detailed information on service roads.

### 4.10.1 Service Road Study

A service road study is done to determine whether it is more economical to purchase a landlocked property(s) or to provide an access to mitigate property damages. Consult local Division and right of way personnel when a service road study is being developed. It is the roadway designer's responsibility to design the preliminary access road and develop the construction cost. Submit a right of way cost request to the NCDOT Right of Way Branch for them to develop a right of way cost for the right of way needed to construct the service road. Once the costs associated with the service road are received, a decision will be made on whether it is economically feasible to construct the service road or to take the entire property. If approved, include the service road in the final construction plans.

Refer to [NCDOT Right of Way Manual](#) Chapter 5.111 to 5.114 for more information on the right of way portion of this process.

## 4.11 Cul-de-Sacs

A cul-de-sac is a street that is closed at one end. Assess dead end streets and, if applicable, provide a barrier or a way to turn around. Barriers can be in the form of an earth berm, concrete barrier, or steel beam guardrail. A turnaround can be in the form of an "L", a "T" or circular in shape. Each type of turnaround has its advantages and disadvantages, but, in general, the final type provided should provide enough room for a school bus to turn around. Discuss the use of turnarounds at the Field Inspection. The Division engineer will be responsible for any administrative action required in the closing or dead-ending of a facility. A sign noting the dead-end street will be provided for a cul-de-sac.

Refer to [NCDOT Subdivision Roads Manual](#) for more information on NCDOT's turnaround design and width requirements.

Refer to GB Chapter 5 Section 5.3.2.10 for universal information on cul-de-sacs and turnarounds.

## 4.12 Roadside Control

Property owners abutting highways have rights of access, but it is important that the highway authority have the power to control and regulate the location, design, and operation of these accesses as well as other roadside elements.

Refer to GB Chapter 4 Section 4.15 for a more detailed roadside control definition.

### 4.12.1 Driveways

Driveways are essentially low-volume intersections which can affect the operation of the roadway. Consider these elements when designing a driveway:

1. Purpose of the driveway (commercial, residential, private, etc.)
2. Types of vehicles using the driveway
3. Impacts to the intersecting roadway
4. Adequate sight distance
5. Design features of the driveway (width of the entrance, length, grade, skew of drive, etc.)
6. Replacing an existing driveway or a new proposed driveway

Generally, ensure all driveways have a grade that slopes away from the highway surface at a rate equal to the slope of the shoulder, but not less than 1/4inch per foot, or greater than 1inch per foot in a normal crown typical section. Continue the slope for a distance equal to the prevailing shoulder width or longer so as not to cause a hump or a depression in the shoulder area. For residential driveways, grades should be determined using an appropriate design vehicle and with the vehicle ground clearance guidance found in the Driveway Grade Section of NCHRP Report 659. Residential driveway grades less than 15% and commercial driveways less than 10% are recommended. Where circumstances require driveway grades in excess of these guidelines, coordination with the project team or Division is needed. Maximum allowable grade, by itself, is not a sufficient control. The difference between successive grades can be just as important. Maintain the slopes of drives compatible with provisions for drainage of the designed cross section.

Where a sidewalk is located close to the curb line and the driveway opening is to be provided across a depression or curb cut; construct the sidewalk to conform to the driveway profile. Either one or both edges of the sidewalk may be depressed across the driveway provided the resulting change in vertical drop at the driveway does exceed 1/2-inch or cumulative 10 percent slope. In some cases, it may be necessary to discontinue the sidewalk across the driveway and construct a curb along each driveway edge. In such instances, construct the curb cuts and curb ramps in conformance with the latest edition of the [NCDOT Roadway Standard Drawings Std. No. 848.06](#); the U.S. Department of Justice [2010 ADA Standards for Accessible Design](#); and U.S. Access Board [Public Right of Way Accessibility Guidelines](#) (PROWAG).

Where curbs are cut for the construction of driveways, remove the entire curb and gutter section. Removal of only the raised portion of the curb and paving over the gutter section is not allowed. Taper cut curb ends from full height to ground level in a distance of approximately 2 feet or constructed with radii as required. Where drainage is carried along the curb, construct the driveway in such a fashion to prevent runoff from spilling into private property.

Ensure the maximum difference between the cross slope of the travel way (usually 1/4-inch per foot or approximately 2 percent) and the slope of the driveway to the sidewalk does not exceed 5 percent. Breakover (rollover) angles in excess of 5 percent may not provide for satisfactory driveway speeds. The maximum breakover angle also applies to roadways with shoulders especially on high-speed rural highways. On high volume driveways, use a vertical curve with the access connection to the adjacent public roadway. Figure 4-8 shows the profile of a commercial or residential driveway.



Figure 4-8 Commercial and Residential Driveway Profile

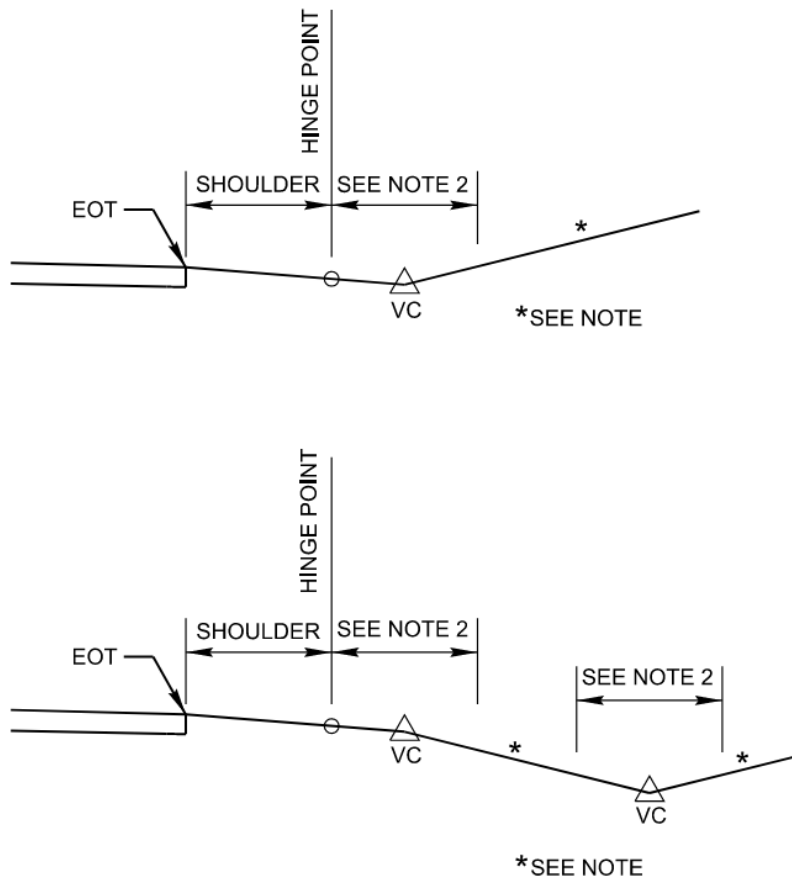

## Notes:

1. The driveway profile should tie to the edge of travel and match the shoulder slope to the hinge point.
2. Recommended minimum length for VC is 5' to 10' to accommodate design based on vertical, drainage, and design vehicle constraints.
3. Residential driveway grades less than 15% and commercial driveways less than 10% are recommended. Where circumstances require driveway grades in excess of these guidelines, coordination with the project team or Division is needed.
4. The driveway profile should match the existing driveway grade at the tie.

In general, replace driveways in kind. If the grade of the driveway being replaced is greater than 7 percent, pave the driveway. Consult the Pavement Management Section for the type and thickness of the pavement to be used.

For commercial driveway entrances (those that generate more than 500 ADT or more), design a paved driveway turnout in accordance with [NCDOT Roadway Standard Drawings](#) Std No. 848.04. Commercial driveway entrances should be designed to accommodate the predominant design vehicle used at the commercial facility. Discuss the width of commercial driveways with the Division at the Field Inspection. For commercial driveway entrances that generate less than 500 ADT, a paved driveway turnout in accordance with [NCDOT Roadway Standard Drawings](#) Std. Nos. 848.02 or 848.03 may be used.

Provide a 20-foot minimum width for private driveway turnouts with curb and gutter in accordance with [NCDOT Roadway Standard Drawings](#) Std. Nos. 848.02 or 848.03. Where justified and approved, the minimum 20-foot width may be reduced to 16 feet. For non-curb and gutter facilities, provide a total graded width of no less than 16 feet. This provides for an effective 12-foot paved or aggregate travel way.

Refer to RDM Part I Chapter 7 Section 7.5 for treatment of driveway cross pipes.

Discuss standard street and driveway turnouts during the Field Inspections.

Lay out driveways with sidewalk crossings in accordance with [NCDOT Roadway Standard Drawings](#) Std. Nos. 848.02 and 848.03.

When widening an existing roadway, ensure all existing access connections being replaced conform to the current edition of the NCDOT Policy on Street and Driveway Access to North Carolina Highways. Do not place or alter new driveway turnouts or connections on the final plans without the express consent and approval of the local district engineer. When it is determined that a new access connection will be allowed, a separate agreement between the Department of Transportation and the applicant will be required.

Refer to GB Chapter 4 Section 4.15.2, and Chapter 9 Section 9.11.6 for additional driveway information.

Refer to [NCDOT Policy on Street and Driveway Access to North Carolina Highways](#) for more information on driveway access.

### 4.12.2 Mailboxes

Mailbox placement may create a risk to motorists. Consider factors such as sight distance near the mailbox, highway or street cross sectional dimensions, and traffic volume when determining their location.

Refer to GB Chapter 4 Section 4.15.3 for more information on mailbox placement.

Refer to RDG, Chapter 11; North Carolina Administrative Code Section 2E.0404 [Highway Obstructions Interfering with Traffic/Maintenance](#); and [NCDOT Subdivision Roads Manual](#) for more detailed information on mailbox placement and design considerations.

### 4.12.3 Fencing

Fences are barriers used to contain, enclose, or delineate one area from another. Fencing is used by NCDOT to delineate the control of access for a highway. On projects where existing fencing is removed, where applicable, NCDOT will replace or remove and reset the fence that was disturbed. Temporary fencing is used to contain livestock while a project is being constructed until final fencing can be installed. Common fencing types are chain link, barbed wire, and woven wire. When a project falls within their jurisdiction, municipalities may request special or decorative fencing.

Refer to RDM Part II Chapter 14 Sections 14.6, 14.7, and 14.8 for detailed information on fencing placement in NCDOT plans.

## 4.13 Tunnels

Consider the use of a tunnel when encountering a natural obstacle or need to minimize the effects of the roadway or highway on a community. Tunnels can be broken down into two categories: those constructed with mining methods and those constructed by cut and cover methods. Consider pedestrians in tunnel design, either for maintenance or mobility. Once it is determined a tunnel may be required, consult with the Structures Management Unit and Geotechnical Engineering Unit for design considerations.

Refer to GB Chapter 4 Section 4.16 for more information on tunnel considerations and tunnel typical sections.



Refer to RDM Part II Chapter 16 Section 16.4.5 for information on tunnel lighting.

## 4.14 Pedestrian Facilities

Pedestrian networks are fundamental to supporting transportation for people of all ages, abilities, and economic opportunities. Consider pedestrian facilities, such as sidewalks, sidepaths, and crossings, as a critical part of the roadway design with few exceptions. Coordinate with the Integrated Mobility Division when considering the design elements below.

Follow the latest Public Right-of-Way Accessibility Guidelines ([PROWAG](#)); the AASHTO *Guide for the Planning, Design, and Operation of Pedestrian Facilities* 2nd Edition; and the latest *ADA Standards for Accessible Design* when developing pedestrian design elements.

Refer to GB Chapter 4 Section 4.17, and Table 3 Facility Selection Matrix in the [NCDOT Complete Streets Project Evaluation Methodology](#) for guidance pertaining to the selection of pedestrian accommodations.

### 4.14.1 Sidewalks and Berms

Sidewalks are an integral part of multimodal transportation networks where people are expected to walk to destinations as part of urban, suburban, or rural settings. Sidewalks provide a path for pedestrians parallel to the roadway, providing safer access to destinations and public transportation. Widths of sidewalk vary depending on their use and volume of foot traffic. NCDOT policy is to replace existing sidewalk that has been disturbed by an NCDOT project. When a project falls within their jurisdiction, municipalities may request sidewalks throughout the project, or to connect one existing section of sidewalk to another existing section of sidewalk. Municipalities may also request wider sidewalk or shared-use paths to accommodate pedestrians and bicycles. Coordination with the municipality, facility cost, and impacts will determine when a sidewalk is wider than the standard width.

Refer to [NCDOT Complete Streets Implementation Guide](#) Chapter 6 for details on sidewalk cost sharing.

If sidewalk construction is proposed, include information in the project planning report and ensure design meets all of the ADA requirements. The widths shown in Table 4-8 will work for most projects, but heavy pedestrian traffic may warrant wider widths:

**Table 4-8 Desirable and Minimum Sidewalk and Berm Widths**

	Commercial and School Routes		Residential Areas	
	Desirable	Minimum	Desirable	Minimum
Sidewalk Width	10'	5'	5'	4'
Berm Width	17'	6'	10'	5'

Refer to Section 4.7 above for more information on berm widths.

Construct one of the berm sections shown in Figure 4-6 if sidewalk is not constructed initially but is anticipated.

Place sidewalk at a rising 0.02 slope from the back edge of curb and gutter. Use 4-inch thick sidewalk unless conditions warrant otherwise. Refer to [NCDOT Roadway Standard Drawings](#) Std. No. 848.01.

For pedestrian safety in areas of high fill or shear drop, the addition of pedestrian safety rail or fencing may be required. Where the drop is greater than 30 inches adjacent to the pedestrian facility, include pedestrian safety railing or fencing for fall protection.

Refer to AASHTO *Guide for the Development of Bicycle Facilities* (2012) 4th Edition:

The minimum railing height for bicycle and pedestrian facilities is 42". On high-speed bridges (design speed greater than 45 mph) where a steep-angle impact could occur between the bicyclist and the railing, such as at a curve, consider a railing that would meet a 48" minimum height.

Collaborate with NCDOT Integrated Mobility Division to determine the best treatment for each situation.

Lateral offset from an obstruction (bushes, large rocks, bridge piers, abutments, guardrail, poles, etc.) to edge of sidewalk:

- Desirable 2-foot lateral offset
- Minimum 1-foot lateral offset

For sidewalk located on bridges and bridge approaches, deviation from the minimum 1-foot lateral offset criteria will be allowed to adhere to the current guidance for bridge deck widths as illustrated in RDM Part I Chapter 5 Figures 5-4 ~~thru~~ through 5-6 and Figures 5-9 ~~thru~~ through 5-11.

Refer to GB Chapter 4 Section 4.17.1 for detailed sidewalk information.

#### 4.14.1.1 Shared-Use Paths, Sidepaths, and Greenways

Shared-use paths, often referred to as greenways, are paths physically separated from motor vehicle traffic and used by pedestrians, bicyclists, skaters, wheelchair users, and other non-motorized users. Most shared-use paths are designed for two-way travel. Sidepaths are shared-use paths located immediately adjacent to and parallel to the roadway, or within the right of way.

Sidepaths and other shared-use paths are wider than sidewalks, accommodating both bicyclists and pedestrians, and are used for both transportation and recreational uses. The width of a shared-use path may vary, based on expected user volumes and context. Minimum widths do not include graded areas or buffers on either side of the pathway. More detailed guidance on graded shoulder in constrained areas, applications on steep slopes and accommodations for emergency vehicles, bicycles and pedestrian railing needs can be found in AASHTO *Guide for the Development of Bicycle Facilities* (2012) 4th Edition, Chapter 5.

- Desirable width – 12 to 14 feet
- Minimum width – 10 feet; 8 feet in constrained areas.
- Vertical clearance of 10 feet is desirable, minimum – 8 feet in constrained areas.

Lateral offset from an obstruction (bushes, large rocks, bridge piers, abutments, guardrail, poles, etc.) to edge of shared-use paths, sidepaths, and greenways:

- Desirable 4 feet lateral offset
- Minimum 2 feet lateral offset

Shared-use paths follow federal requirements for accessibility per the U.S. Access Board and the U. S. Department of Justice. Refer to [PROWAG](#) Chapter 3 Section R302.5 and R302.6. Minimum requirements follow the [2010 ADA Standards for Accessible Design](#).

Refer to [NCDOT Minimum Design Recommendations for Greenways](#) for pavement design, when applicable.

Refer to AASHTO *Guide for the Planning, Design, and Operation of Pedestrian Facilities*, and AASHTO *Guide for the Development of Bicycle Facilities* (2012) 4th Edition, Chapter 5 for more detailed information.

#### 4.14.2 Grade Separated Pedestrian Crossings

Grade separated facilities allow pedestrians to cross over or under a roadway safely without vehicle interference or conflict. Ensure grade separated pedestrian crossings meet all ADA requirements. Include pedestrian overpasses in the environmental document for the project. Submit design of pedestrian overpasses as a structure recommendation report to the Federal Highway Administration or the Structures Management Unit, or both as needed.

Refer to RDM Part I Chapter 5 Section 5.4 for design details on grade separated pedestrian crossings.

Consider pedestrian underpasses where greenway facilities with pedestrian or bicycle use are existing or part of a planned system. Where greenway facilities are being considered under a bridge, design the bridge with sufficient width under the structure to accommodate the greenway.

Refer to Section 4.14.1.1 above for more information about walkway vertical clearance standards.

Refer to [NCDOT Guidelines for Inclusion of Greenway Accommodations Underneath a Bridge as part of a NCDOT Project](#) for more information on cost sharing guidelines.

Underpasses for greenways that are determined by using floodway maps and have not been designated as actual trails can be constructed if the city or county supplements the cost in accordance with Chapter 6 Cost Share of the *NCDOT Complete Streets Policy*.

Refer to GB Chapter 4 Section 4.17.2 for more information on grade separated pedestrian crossings.

##### 4.14.2.1 Pedestrian Roadway Crossings

Anticipate pedestrian crossings both at intersections and at midblock locations, where pedestrian destinations are on either side of the roadway.

Refer to [NCDOT Roadway Standard Drawings](#) Std. No. 848.06 for detailed dimensions for pedestrian refuge islands, crossing islands at channelized right turn lane intersections, curb extensions, and raised crossings.

Consult with the NCDOT Traffic Safety Unit and the division traffic engineer and the Integrated Mobility Division to determine placement and design of pedestrian roadway crossings.

Refer to [FHWA MUTCD](#) for information on marked crosswalks, signs and traffic control devices at pedestrian crossings. For additional information about required roadway markings and signage for pedestrian crossings, consult with the NCDOT Signing and Delineation Unit.

Refer to [NCDOT Pedestrian Crossing Guidance](#) for more information on pedestrian crossings.

### 4.14.3 Curb Ramps

Facilities for pedestrians are required to be readily accessible to and usable by individuals with disabilities. Curb ramps are necessary to provide access between the sidewalk and street at pedestrian crossings. The Signing and Delineation Unit is responsible for showing the Curb Cuts and Ramps on the Pavement Marking Plans. The symbol used to denote Curb Cuts and Ramps on the plan sheets is “CR”. The roadway engineer is responsible for the coordination of Curb Cuts and Ramps locations for possible conflicts with pavement markings, signal poles, fire hydrants and other utilities. Coordinate with other units whose designs are impacted by the placement of the curb cuts and ramps placement. Ensure curb ramps meet all ADA requirements. Include detectable warnings to alert visually impaired persons. Design curb ramps for the handicapped in accordance with [NCDOT Roadway Standard Drawings](#) and Curb Ramp Details. Show a special detail in the plans when any type of curb ramp is proposed on a project that is not in accordance with [NCDOT Roadway Standard Drawings](#) Std. No. 848.06.

Curb ramps and their locations will continue to be shown in the pavement marking plans. The Signing and Delineation Unit will coordinate with the Divisions and the roadway designer to determine if standard curb ramps can be used.

If it is determined that the standard curb ramps shown in the [NCDOT Roadway Standard Drawings](#) are not applicable, the Signing and Delineation Unit will be responsible to notify the Contract Standards and Development Unit and the roadway designer with the proposed alternate curb ramp types.

The Contract Standards and Development Unit and the roadway designer will be responsible to include the alternate curb ramp design details into the roadway plans. Additionally, the roadway designer will add a note to the applicable final roadway design plan sheets for the contractor to refer to the final pavement marking plans for curb ramp type(s). Consult the [State Plans and Standards Engineer](#) in the Contract Standards and Development Unit to obtain alternate curb ramp design details that could be applicable to the project.

Refer to GB Chapter 4 Section 4.17.3 for more information on curb ramps.

Refer to [NCDOT Roadway Standard Drawings](#), Std. No. 848.06 for detail drawings.

### 4.14.4 Stairs

Stairs are a set of steps that lead from one level to another level. The type of stairs to construct shall be determined by the division engineer. When existing steps are being disturbed, it is customary to replace the disturbed stairs with the same type of stairs. Depending on the height of the stairs, handrails may need to be provided for safety purposes.

Refer to [NC State Building Code](#) to determine when handrails are required on stairs.

If stairs are required for a project, consult the [State Plans and Standards Engineer](#) in the Contract Standards and Development Unit to request special details to be included.

## 4.15 Bicycle Facilities

Bicycling is recognized as a mode of transportation. Assume that all roads and streets, where bicyclists are legally permitted, will be used by bicyclists. Consider the needs of bicyclists in the design of each roadway and address those needs in all phases of planning, design, and construction. Determine the need for bicycle facilities as early in the design process as possible since the incorporation of bicycle facilities into the project can affect the cost and overall footprint of the project. The typical width for bicycle lanes is 5 feet. The width and location can

vary according to the discussion between NCDOT and local municipalities and their interest in cost sharing in the bicycle facility.

Refer to GB Chapter 2 Section 2.7 and Chapter 4 Section 4.18 for additional information on bicyclists and bicycle facilities.

Refer to AASHTO *Guide for the Development of Bicycle Facilities* (2012) 4th Edition Chapter 4 for more information.

Refer to Table 3 Facility Selection Matrix in the [Complete Streets Evaluation Methodology](#) for guidance pertaining to the selection of bicycle accommodations.

#### 4.15.1 Shared Lanes

A shared lane is where bicyclists and motor vehicles share the same travel lanes; it is not a formal bikeway facility. While these facilities do not generally offer the highest level of comfort for the bicyclists, they are appropriate in settings with low speeds, low volumes, and good sight distance.

Refer to AASHTO *Guide for the Development of Bicycle Facilities* (2012) 4th Edition Chapter 4 Section 4.3 for additional information.

A marked shared lane facility provides more guidance to both the bicyclists and motorists through the use of a shared lane pavement marking, commonly called a sharrow. These markings are not appropriate on roadways that have a speed limit above 35 mph.

Refer to AASHTO *Guide for the Development of Bicycle Facilities* (2012) 4th Edition Chapter 4 Section 4.4 and [FHWA MUTCD](#) for additional information.

#### 4.15.2 Bicycle Boulevards

A bicycle boulevard is a modified roadway or a network of continuous roadways that function as a through street for bicyclists while discouraging motor vehicle through travel or reduces vehicle travel speeds. Various geometric design features may be considered for bicycle boulevards, including raised islands, curb extensions, raised crossings, and other traffic calming features.

Refer to AASHTO *Guide for the Development of Bicycle Facilities* (2012) 4th Edition Chapter 4 Section 4.10 for additional information.

#### 4.15.3 Bicycle Lanes

A bicycle lane is a designated portion of the road specifically for use by bicyclists generally denoted by pavement markings and signs. The bicycle traffic is typically one way and in the same direction as that of the adjacent roadway.

Refer to AASHTO *Guide for the Development of Bicycle Facilities* (2012) 4th Edition Chapter 4 Section 4.5 for additional information.

Refer to the FHWA Bikeway Selection Guide supplement [On Street Motor Vehicle Parking and the Bikeway Selection Process](#) for design guidance specific to bicycle lanes adjacent to on-street parking.

- Desirable width – 6 to 7 feet, especially adjacent to on-street parking
- Minimum width – 5 feet, not inclusive of gutter pan

#### 4.15.4 Buffered Bicycle Lanes

A buffered bicycle lane is a bicycle lane separated from the adjacent traffic lane and parking by longitudinal pavement markings. The buffer area might include chevron or diagonal markings, typically at least 2 feet wide. Use this type of facility when a separated bicycle lane is desired but not feasible.

Refer to [FHWA Bikeway Selection Guide](#) Chapter 5 for a more in-depth comparison between buffered and separated bicycle lanes.

#### 4.15.5 Separated Bicycle Lanes

A separated bicycle lane is an exclusive facility for bicyclists located in or directly adjacent to the roadway but physically separated from vehicle traffic with a vertical element. Separated bicycle lanes can be one-way or two-way and may be directional (with traffic flow) or contra-flow to traffic. Two-way separated bike lanes require more consideration at transitions between bikeway types and through intersections.

Refer to [FHWA Separated Bike Lane Planning and Design Guide](#) for additional information.

- Desired width – 6.5 feet, exclusive of gutter pan (one-way)
- Minimum width – 5 feet, exclusive of gutter pan (one-way)

While these design standards and guidelines are geared towards bicyclists, best practices will also serve other micro-mobility users such as e-scooters.

Refer to GB Chapter 4 Section 4.18 for additional information.

Refer to [FHWA MUTCD](#) for information on signs and traffic control devices associated with bicycle facilities.

Consult with the NCDOT Signing and Delineation Unit for additional information or guidance on required roadway markings or signage for bikeways.

### 4.16 Transit Facilities

Transit comes in several different modes but the most common a designer may need to design to accommodate are buses, rapid transit, and light rail transit. Transit facilities often include motorists, bicyclists, pedestrians, and transit vehicles. Because of this interaction, discuss incorporation of a transit facility as early in the design process as possible and include representatives from NCDOT, county, and local municipalities.

The [NCDOT Freeway and Street-based Transit \(FAST\) Vision Study](#) provides four main recommendations:

1. Create a bus rapid transit system that gives buses priority on roads to get commuters to their destinations quicker
2. Allow busses to use the shoulders in congested traffic
3. Provide signal priority for buses
4. Provide more bus stops

In urban areas, bus transit is the most common form of public transit.

Refer to GB Chapter 4 Section 4.19; AASHTO *Guide for the Design of Transit Facilities on Streets and Highways*; National Association of City Transportation Officials [NACTO Transit](#)



[Street Design Guide](#); and [NCDOT Freeway and Street-based Transit \(FAST\) Vision Study](#) for detailed information on transit facilities.

Refer to [NCDOT Bus Shelter & Bus Stop Guidelines](#) (February 3, 2017) for additional guidance on the safe and uniform placement of bus stops, benches, and shelters within NCDOT right of way.

## 4.17 On-Street Parking

Consider on-street parking in urban areas and rural communities located on arterial highway routes to accommodate existing and developing land uses. When roadway improvements include on-street parking, design for parallel type parking when possible. General guidelines for on street parking include:

1. Provide a minimum parking space width of 10 feet.
2. Provide a minimum parking space length of 20 feet.
3. End parking a minimum of 20 feet before the intersection.

These numbers vary according to the site location constraints.

Consider angled parking if appropriate for the specific function, width of the street, adjacent land use, traffic volume, and anticipated traffic operations.

Refer to GB Chapter 4 Section 4.20; [PROWAG](#); and [NACTO Transit Street Design Guide](#) for a more detailed definition.

This page intentionally left blank.



# Chapter 5 Structures

## 5.1 Usage

This chapter defines a variety of geometric and hydraulic design requirements and guidelines associated with roadway and multimodal bridges, retaining walls, and sound barrier walls. This chapter replaces the former Bridge Policy. Designs shall conform to the requirements of this chapter in the same manner as previous designs conformed to the former Bridge Policy.

### 5.1.1 Exceptions to Guidelines

In general, apply the criteria presented in this chapter unless project-specific conditions dictate otherwise. On a case-by-case basis, develop project-specific design criteria during [NCDOT Project Delivery Network](#) (PDN) activity 2RD1 for projects with special requirements, such as:

- Bridges with long spans
- Bridges with total lengths greater than 200 feet
- Locations with special significance, such as:
  - Close proximity to historic sites or public parks
  - Movable bridges or other specialty structure types
  - Other special features.

Consider items such as:

- Unique site conditions
- Stakeholder agency requirements
- Accident experience
- Future traffic growth (which may suggest providing wider bridge decks or larger horizontal clearances to accommodate future widening of facilities)
- Commitments documented in the National Environmental Policy Act/State Environmental Policy Act (NEPA/SEPA) documents (PDN Activity 2EP1).

As an example, an exception may be considered when more cost-effective criteria are warranted to provide continuity along the existing facility. Such exceptions may be warranted when the project involves little or no approach roadway work and additional improvements to the facility are not anticipated in the near future.

Such project-specific design criteria may deviate from guidance presented here and elsewhere in the RDM. Coordinate with the Project Manager, NCDOT discipline leads, and NCDOT Division representatives as needed when considering deviations from the criteria.

Refer to RDM Part II Chapter 17 for guidance on design exceptions.

### 5.1.2 Existing Bridges to Remain

Over time, facility improvements encourage higher speeds and attract larger vehicles. Existing substandard structures may need rehabilitation, widening, or replacement. Because of the high cost of new structures, existing bridges and culverts that meet acceptable criteria should be retained.

Where an existing highway is to be reconstructed or widened, retain existing bridges that meet the following criteria:

1. The bridge geometry fits the proposed alignment and profile.
2. The bridge is structurally sound.
3. Bridge rails meet, or can be upgraded to meet, current performance requirements.
4. The safe load carrying capacity meets current performance requirements (see below).
5. There is no significant accident history in the vicinity of the existing bridge.
6. The bridge clear deck width meets requirements defined herein.

Existing bridges that meet the above criteria except that they provide deficient clear deck width should be considered for widening. In such cases, widen the bridge to the same dimension as recommended for a new bridge. See Table 5-1 for minimum clear roadway width and vertical clearance requirements for existing bridges to remain in place. The guidance in Table 5-1 reflects traditional policy; this guidance is in the process of being revised in a future update.

**Table 5-1 Minimum Clear Roadway Width and Vertical Clearances for Existing Bridges to Remain in Place**

Minimum Clear Roadway Width for Existing Bridges to Remain in Place						
Local Design ADT <sup>1</sup>	Local <sup>2</sup>	Design ADT	Collector <sup>2</sup>	Arterial	Freeway	Interstate
≤ 250	20'	≤ 400	22'	28' <sup>3,7</sup>		
251 to 1,500	22'	401 to 1,500	22'	28' <sup>3,7</sup>		
1,501 to 2000	24'	1,501 to 2,000	24'	28' <sup>3,7</sup>		
> 2,000	28'	> 2,000	28'	28'	24' plus paved shoulders <sup>4</sup>	24' plus paved shoulders <sup>5</sup>
Minimum Vertical Clearances for Existing Bridges to Remain in Place						
	14'		14'	14'	14'	16' <sup>6</sup>

Notes:

1. ADT = Average Daily Traffic.
2. Bridges longer than 100' may be analyzed individually in accordance with recommended minimum width of traveled way and shoulders in the GB, referring to the appropriate chapter based on roadway functional classification. The designer should consider the condition of the structure, the clear width provided, crash history, traffic volumes, design speed, snow storage, and other pertinent factors.
3. For arterials with 11' lanes and design speeds of 40 mph or less, 26' may be used.
4. As a minimum, an Accident History Evaluation should be completed to determine if additional width is required. Ultimate widening should be considered for all existing bridges with less than 3' offsets to parapets. Bridges longer than 200' may be analyzed individually.
5. Bridges longer than 200' may be analyzed individually in accordance with recommended minimum width of traveled way and shoulders in the GB Chapter 8 Section 8.2.4. The designer should consider the condition of the structure, the clear width provided, crash history, traffic volumes, design speed, snow storage, and other pertinent factors (4' minimum offset to parapet required).
6. Minimum 14' on Urban Interstate when there is an Alternate Interstate Routing with 16' clearance.
7. Width of travel way may remain at 22' (plus paved shoulders) on reconstructed highways where alignment and safety records are satisfactory.

The Structures Lead should determine the required safe load carrying capacity of existing bridges during PDN Activity 1ST1, Initiate Structures Investigation. To consider retaining an existing bridge in place, it should provide the following safe load carrying capacity:

- Bridges carrying interstate, freeway, or arterial traffic – The safe load carrying capacity should be 10 percent greater than that required to carry North Carolina Legal Loads when load-rated in accordance with the [NCDOT Structures Management Unit Manual](#).
- Bridges carrying local and collector traffic – The bridge shall be load-rated (and load posted, if necessary) in accordance with the [NCDOT Structures Management Unit Manual](#) to a weight limit determined to meet the needs of the route served; however, the safe load capacity shall be sufficient to carry school buses and vital services vehicles where there is no reasonable or adequate alternate route.

## 5.2 Guidelines for Subregional Tier Bridge Projects

### 5.2.1 Usage

The Subregional Tier Design Guidelines (SRTG) in this section define the design requirements for bridge replacement projects only on North Carolina Highway System facilities designated as minor collectors, local, or secondary roads. This section replaces the former SRTG (February 2008). Qualifying designs shall conform to the requirements of this section in the same manner as previous designs conformed to the former SRTG (February 2008).

Projects at locations identified by North Carolina's Highway Safety Improvement Program are not eligible for design under the SRTG.

The SRTG ~~establish~~establishes broad limits by presenting minimum values for design to minimize the amount of approach work and to maximize the limited funds available for the bridge program. Consider site-specific conditions and apply prudent engineering judgment when applying these guidelines. Design projects to provide safety and desirable levels of service appropriate to the social, economic, and environmental conditions of each project. The SRTG ~~establish~~establishes bridge replacement design criteria intended to maintain current operating conditions without compromising safety. These guidelines emphasize minimizing changes in the vertical grade, structure length and width, approach roadway limits, and right of way for each site. When appropriate, consider options to rehabilitate rather than replace existing bridges and options to use accelerated construction techniques.

Coordinate with the Project Manager, Structures Lead, Hydraulic Design Engineer, Design Geotechnical Engineer, Traffic Analysis Engineer, NEPA/SEPA Lead, and Division Engineer or Project Management Unit, as appropriate, during PDN Activity 1FS3, Complete Project Scoping Report, to determine whether to design the project following the SRTG.

Refer to section 13.2.6 for determining the appropriate tier (Statewide, Regional or Subregional).

### 5.2.2 Geometric Design Criteria

During PDN Activity 1RD1, Initiate Roadway Coordination, obtain available traffic forecasts developed by the Traffic Analysis Engineer during PDN Activity 1TP1 and available safety data (e.g., crash data, available volumes including non-motorists, and roadway characteristics data) developed by the Traffic Safety Planning Engineer during PDN Activity 1TS1. If traffic forecasts for the facility are not available, use engineering judgment to interpret other nearby available

traffic data. When crash and severity rates are below the statewide averages, use the geometric design criteria presented in this section for SRTG projects.

Exercise appropriate engineering judgment to achieve desirable levels of traffic service and safety, while considering site-specific conditions. At a minimum, provide a design that maintains current operating conditions. Provide appropriate safety improvements at documented and potentially hazardous locations.

For low-volume roads, consider using the current AASHTO *Guidelines for Geometric Design of Low-Volume Roads* (2019) in lieu of the SRTG. Coordinate with the Project Manager, Division Engineer, and NEPA/SEPA Lead regarding this decision. A low-volume road is defined as a facility that is functionally classified as a local or minor collector road and has a design average daily traffic volume of 2,000 vehicles per day or less.

Specific geometric design criteria for SRTG projects include:

### Design Speed

Refer to RDM Part I Chapter 2 Section 2.2 to determine the design speed during PDN Activity 1RD1, considering the topography, anticipated operating speed, use of adjacent land, and functional classification of the highway. Share the identified design speed with the NEPA/SEPA Lead for them to record in the NEPA/SEPA documents in PDN Activity 2EP1.

Design pertinent highway features in relation to the design speed to obtain a balanced design. Unless otherwise noted, references to design speed throughout Section 5.2 refer to this identified design speed.

The Safety Planning Group in the Traffic Safety Unit will provide Bridge Speed Investigations to assist the Bridge Replacement Program in producing safe and economical bridge designs for low volume roadways. Low volume roadways are defined as having less than or equal to 2,000 ADT.

### Lane and Shoulder Widths

Determine lane and shoulder widths in accordance with Table 2 in the guide [NCDOT Resurfacing, Restoration, and Rehabilitation \(R-R-R\) of Highways and Streets](#). The lane and shoulder widths listed in that table are the minimum acceptable values; do not use lane or shoulder widths on the bridge narrower than those of the approach roadway typical section.

### Bridge Width

See Table 5-2 for minimum bridge width criteria. The Roadway Design Lead should coordinate with the Structures Lead during PDN Activity 2RD1 to determine if it is appropriate to provide a wider bridge. Refer to Section 5.3.6.1 below for specific guidance on bridge widths when cored slab or box beam bridges are proposed.

**Table 5-2 Clear Bridge Deck Widths for SRTG Projects**

20-Year DESIGN ADT	≤ 4000 vehicle/day		> 4000 vehicle/day	
	≤ 45 mph	> 45 mph	≤ 45 mph	> 45 mph
Minimum clear bridge deck width <sup>1</sup>	24'	26'	28' <sup>2</sup>	

Notes:

1. In no case shall the clear bridge deck width be less than the approach roadway width (including paved shoulders).
2. For current average daily traffic (ADT) over 3,000 vehicle/day, use 30'.

### Horizontal Clearance

Refer to Section 5.3.3 below; use Horizontal Clearances for Local and Collector System facilities.

### Vertical Clearance

Refer to Section 5.3.4 below.

### Horizontal Alignment

If the calculated design speed for the alignment is within 10 mph of the project's required design speed, consider retaining the existing horizontal alignment. Provide correct superelevation as discussed below under Cross Slope and Superelevation.

Refer to RDM Part I Chapter 3 Section 3.3 for discussion of horizontal alignment.

### Vertical Alignment

Consider retaining the existing vertical profile if the calculated design speed is within 20 mph of the project's required design speed and the design traffic volumes are less than 1,500 vehicles/day or is within 10 mph of the project's design speed regardless of the traffic volumes. Apply engineering judgment to achieve desirable levels of traffic service and safety, considering site-specific conditions. Maintain current operating conditions when appropriate but provide an improved design at documented, or potentially, hazardous locations.

Refer to RDM Part I Chapter 3 Section 3.5 for discussion of vertical alignment.

### Stopping Sight Distance

Provide minimum stopping sight distance for the horizontal and vertical curve conditions as stated above under Horizontal Alignment and Vertical Alignment.

Refer to RDM Part I Chapter 3 Section 3.2.2 for stopping sight distance requirements.

### Cross Slope

Provide cross slopes sufficient to facilitate proper drainage and per cross slope design guidance provided in RDM Part I Chapter 2 Section 2.7.4. Coordinate with the Hydraulic Design Engineer to determine cross slopes.

### Superelevation

Ideally, design superelevation for roadways on curved alignments in accordance with the design guidance presented in RDM Part I Chapter 3 Section 3.4. If minimum superelevation rates cannot be provided, coordinate with the Division Traffic Engineer and the Signing and Delineation Engineer to determine whether to identify the permissible speed with speed limit signs.

### Grades

Consider retaining the existing roadway grade, provided an appropriate minimum grade is provided. Coordinate with Division staff to identify an appropriate minimum grade (typically at least 0.3 percent).

### 5.2.3 Guardrail

Provide guardrail end treatments or transitions at bridge rails on all four corners of undivided two-way, two-lane bridges.

When the design speed is less than 50 mph, provide Test Level 2 (TL-2) Guardrail End Units at each end of the bridge approach. Provide a minimum 12.5-foot-long section of Steel Beam Guardrail between anchors (structural anchors and/or guardrail end units).

When the design speed is equal to or greater than 50 mph, provide a Test Level 3 (TL-3) Guardrail End Unit at each end of the bridge. Provide a minimum 25-foot-long section of Steel Beam Guardrail between anchors (structural anchors and/or guardrail end units).

### 5.2.4 Hydraulic Design

Coordinate with the Project Manager, Hydraulic Design Engineer, and Structures Lead during PDN Activities 2RD1 and 3RD1 to identify appropriate hydraulic design issues and criteria that may affect the roadway design. The Hydraulic Design Engineer will:

- Determine if the project site is Federal Emergency Management Agency (FEMA) regulated or not and what type of study is required.
- Determine the hydraulic design frequency.
- Identify required hydraulic structures and recommend structure types.
- Determine the need for, and recommended type of, bridge deck drainage.
- Determine scour design parameters and potential for debris buildup.

### 5.2.5 Geotechnical Design

Coordinate with the Design Geotechnical Engineer during PDN Activity 2RD1 and 3GT2 to determine if there are any geotechnical design issues that might affect the roadway design. Examples might include identification of unstable slopes, special embankment conditions, or unique pavement conditions.

### 5.2.6 Structural Design

Coordinate with the Structures Lead during PDN Activity 2RD1 to determine if there are any structural design issues that might affect the roadway design. Examples include bridge width considerations, bridge length and span arrangement considerations, and bridge geometry considerations.

Coordinate with the Structures Lead and Design Geotechnical Engineer during PDN Activity 2RD1 to determine which Bridge Approach Fill details to use. Refer to [NCDOT Roadway Standard Drawings](#) Std. Nos. 423.01, 423.02, 423.04 and 423.04 for the standard Bridge Approach Fill details.

## 5.3 Bridges

### 5.3.1 Bridge Information in the Design Recommendation Plan Set

Include roadway design information needed by the Structures Lead to develop Preliminary General Drawings (PDN Activity 2ST2) in the Design Recommendation Plan Set (DRPS) developed in PDN Activity 2RD1. Adhere to the requirements of this chapter when developing the DRPS. Examine each structure to provide the most economical and safest design. Approval of the DRPS submittal will serve as official notification that the Roadway Design review has been completed and any comments relevant to the structure design have been addressed.

Develop the roadway design elements and initial structure geometry in PDN Activity 2RD1 for inclusion in the DRPS. These items should reflect the Approved Design Criteria (PDN Activity 2RD1) and the Traffic Operations Analysis Memorandum (PDN Activity 2TM1).

Include the following structures-related information in the various plans of the DRPS:

#### 5.3.1.1 Title Sheet

Show approximate begin and end bridge stations to the nearest foot (+/-) at the DRPS submittal.

The approximate stations for begin and end bridge in the DRPS should reflect coordination with the Structures Lead during PDN Activity 2RD1. These limits will be verified by the Structures Lead during the development of Preliminary General Drawings (PDN Activity 2ST2). Once the Preliminary General Drawings are approved, update the final stations for begin and end bridge on the title sheet under PDN Activity 3RD1.

#### 5.3.1.2 Typical Section Sheets

Provide a typical section for each proposed bridge, including:

- Lane widths and types
- Cross slopes/superelevation
- Minimum offset from the proposed edge of travel to interior bridge rail
- Other roadway elements that affect the layout of the structure, including, but not limited to:
  - Total width
  - Sidewalk, barrier, fencing, or monolithic island requirements
  - Minimum bridge length requirements associated with spanning any given constraints

Provide a typical section under each proposed grade separation bridge depicting items needed to determine the minimum required span length(s) and vertical geometry of the structure, including:

- Lane widths and types
- Future lane locations and widths, if applicable
- Any positive protection treatments with applicable standards and widths
- Cross slopes/superelevation



- Paved offset and/or distance to the end bent fill slope break point (see Note 1 below)
- If the roadway under the structure is median-divided, also provide:
  - Median dimensions
  - Shoulder and ditch slopes
  - Positive protection treatment with applicable standards and widths
  - Median paved and unpaved shoulders or horizontal offsets at interior bents
- Traffic information for each of the intersecting roadways and minimum vertical clearance information shall not be provided. This data can be found in the approved design criteria on SharePoint.
- Notes designating items to be determined by other units (bridge pier, abutment wall, and retaining wall locations, spill through slopes, etc.) shall not be included.

Note 1: The end bent fill slope break point is defined as the point where a projection of the end bent fill slope intersects a projection of the cross slope of the roadway pavement, unpaved shoulder, or paved offset (i.e., the cross slope of the roadway surface closest to the end bent). Refer to [NCDOT Roadway Standard Drawings](#) Std. Nos. 610.01 through 610.04 for various conditions. If 6-inch slope protection is provided per Std. No. 610.03, the end bent fill slope break point is the PVI of the 6-foot vertical curve, which is at mid-width of the 9-foot wide slope protection.

Note 2: Typical under the structures are not required in the final plan set.

### 5.3.1.3 Plan and Profile Sheets

Show the equality station on both the plan and profile sheets and skew angle on the plan sheet for the intersecting alignments for each bridge location over a roadway or railroad.

Include information that would affect the location, size, or orientation of items such as interior bents, end bents, foundations, retaining walls, or end bent fill slopes; determine the appropriate sheets for presentation of this information on a case-by-case basis.

A bridge/pavement relationship sketch on plan sheets or as a separate detail is not required at any point in the life of the project.

Coordinate with the Structures Design Lead to determine anticipated approach slab length. Show, but do not label, the approximate size of the bridge and approach slabs on the plan sheet for the DRPS submittal.

The stations for the begin and end bridge(s) and approach slab(s) will be incorporated into the plan set (title sheet, typical sections, plan sheets, and profile sheets) once the Preliminary General Drawings are placed on SharePoint by Structures Management at PDN Stage 2ST2. The begin and end approach slab stations should not be placed on the title sheet. It is the responsibility of the roadway designer to retrieve this information for incorporation into the right of way plan set. The roadway design reviewer will verify the plans have been updated per the data on SharePoint.



## 5.3.2 Deck Widths for Bridges

### 5.3.2.1 General Criteria

Determine bridge deck widths during PDN Activity 2RD1 based on the functional classification, traffic conditions (ADT), and widths and types of lanes of the roadway being carried by the bridge. The bridge deck widths should reflect the approved Design Criteria (PDN Activity 2RD1) and approved Traffic Analysis (PDN Activity 2TM1).

Refer to [Figures](#) Figure 5-1 through Figure 5-12 for illustrations of the appropriate deck width for bridges carrying Interstate highways, freeways, arterial system roads, local and collector roads, and ramps. When determining the appropriate deck width, also consult with the Hydraulic Design Engineer to discuss drainage design on the bridge, particularly in cases of significantly wide or long bridges. See Section 5.7.1 for further discussion.

Shoulder widths may be different on the bridge than what is shown in the roadway typical sections approaching the bridge. Evaluate shoulder width requirements on a case-by-case basis, considering the following:

- Bridge lengths greater than 200 feet
- Truck volumes
- Auxiliary lane lengths
- Horizontal sight distance requirements

When evaluating sight distances, consider bridge rail type, offset, horizontal curvature, and crest vertical curves on the structure. Investigate bridges with horizontally curved alignments and bridges on or near ramps.

Refer to RDM Part I Chapter 9 Section 9.4.1.6 for required sight distances at terminals of ramps.

Figure 5-1 Interstate System Bridge Deck Widths for Four or More Lanes Divided Shoulder Approach

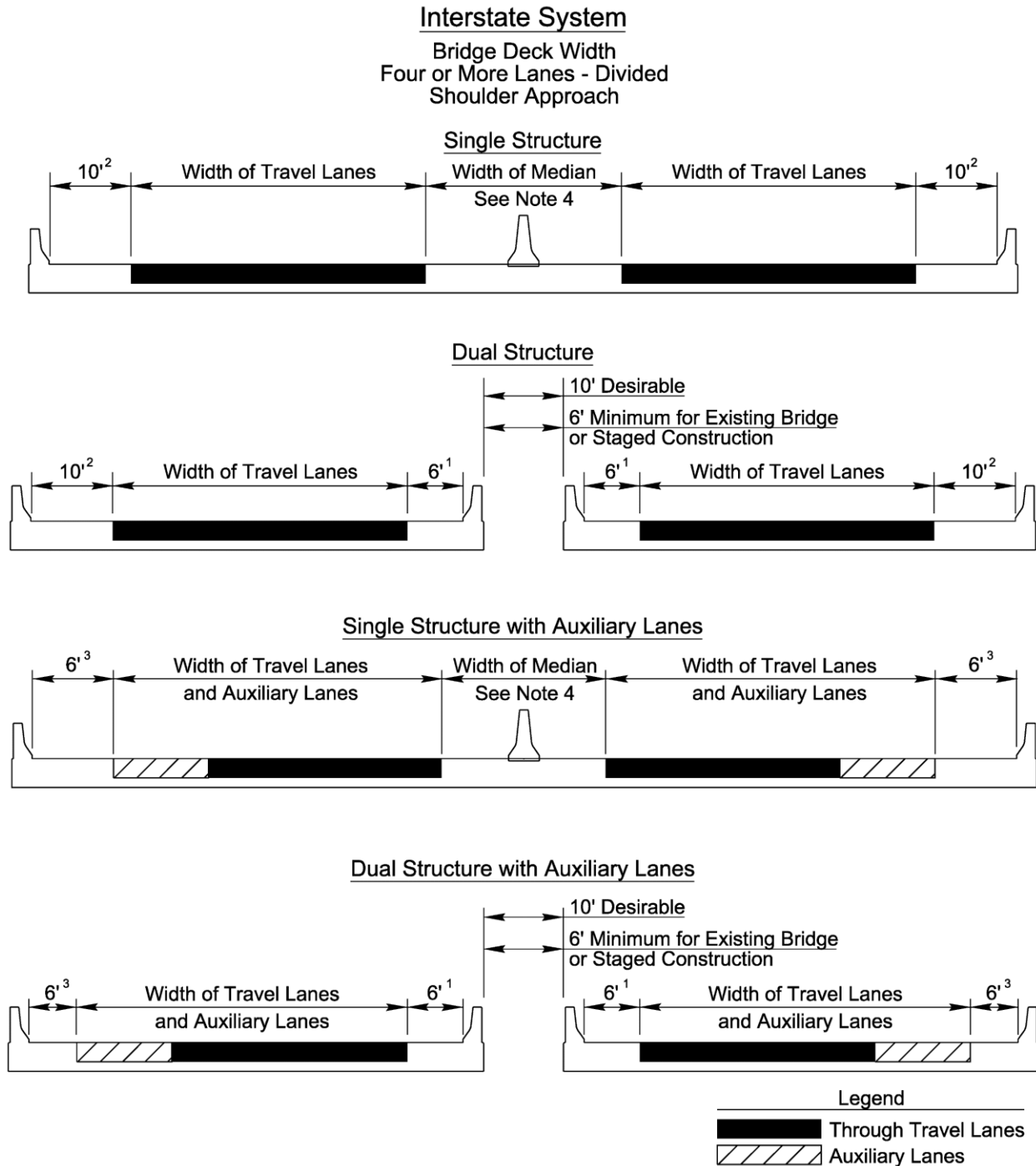

Notes:

1. 10' should be considered with six or more through lanes.
2. 12' should be considered when the design year truck volumes exceed 250 DDHV.
3. Use 10' shoulder when auxiliary lane connects interchanges, or an auxiliary lane is longer than 2,500'.
4. Review Section 5.3.2 in its entirety for additional information on medians across bridges.

Figure 5-2 Freeway System Bridge Deck Widths for Four or More Lanes Divided Shoulder Approach

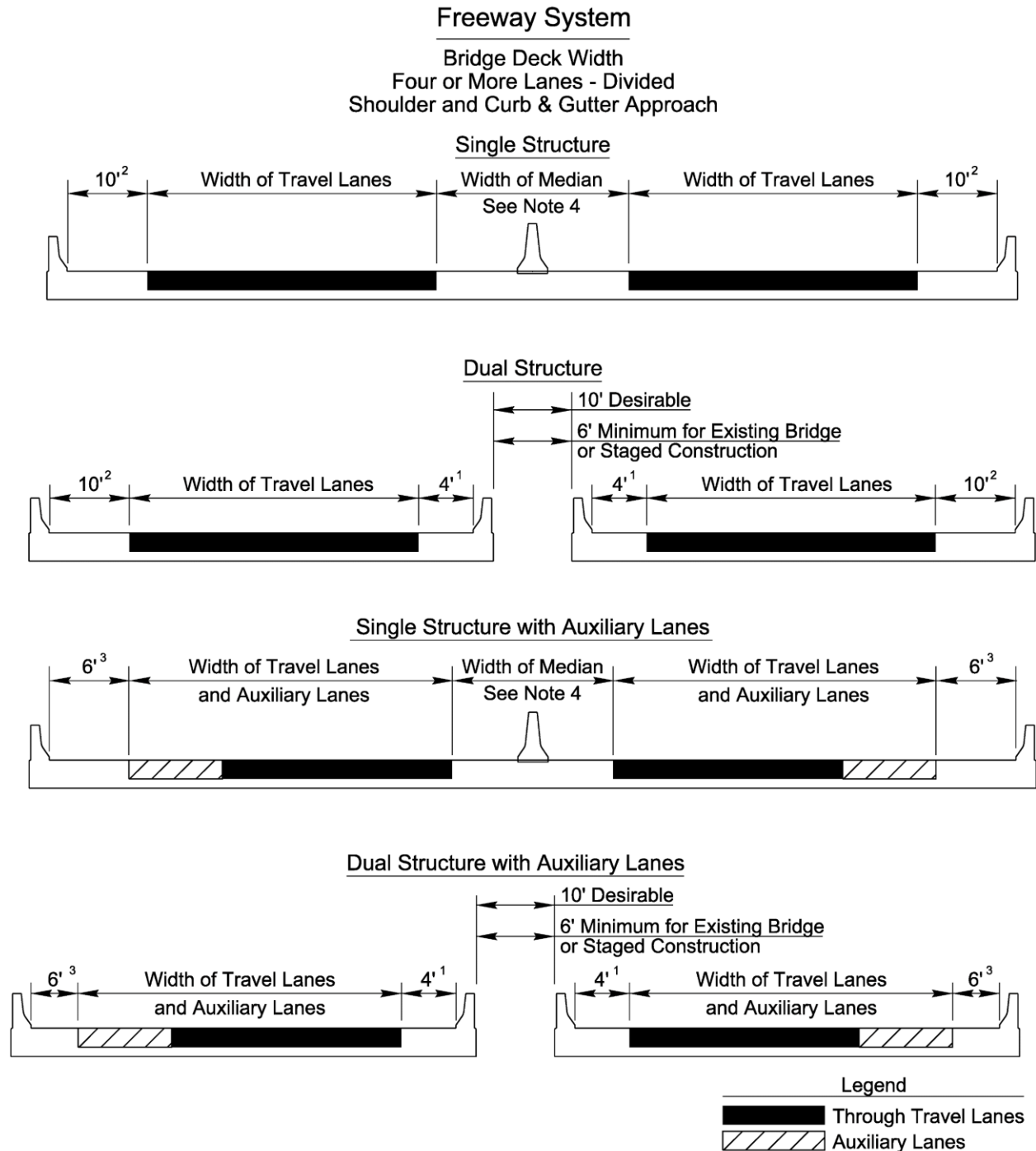

Notes:

1. 10' should be considered with six or more through lanes.
2. 12' should be considered when the design year truck volumes exceed 250 DDHV.
3. Use 10' shoulder when auxiliary lane connects interchanges, or an auxiliary lane is longer than 2,500'.
4. Review Section 5.3.2 in its entirety for additional information on medians across bridges.

Figure 5-3 Arterial System Bridge Deck Widths for Two-Lane Two-Way Traffic

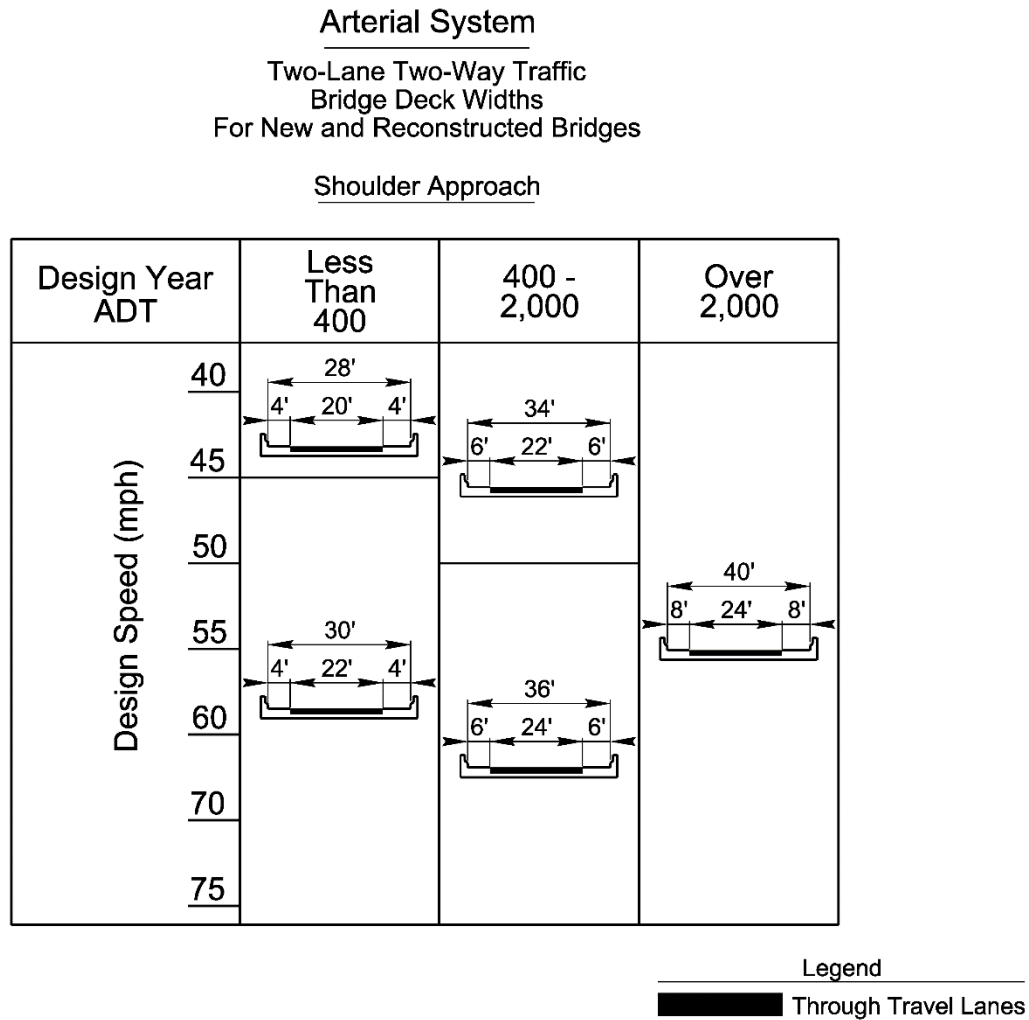

Notes:

1. Bridge deck width charts are based on design year ADT. If only current ADT is available, design year ADT should be obtained from the traffic forecasting unit of the statewide planning branch.
2. Bridges 200' or greater may have a lesser width with NCDOT approval. The offsets to parapet, rail, or barrier shall be at least 4' from the nearest travel lane.
3. Refer to GB Chapter 3 for curve widening consideration.
4. The offset for bridges within the urban area boundary may be increased to a minimum of 7'-6" to accommodate future sidewalks. The engineer should check with the hydraulics unit to determine if additional offset is needed to accommodate for drainage.
5. Refer to Section 5.3.2.5 below for additional considerations on bridges with curb and gutter approaches.
6. When auxiliary lanes are required, add their width to the width of the travel lanes.
7. Minimum shoulder widths of 6' are desired for structures located at interchanges. The minimum values shown above may be used if the required sight distance can be achieved.

Figure 5-4 Arterial System Bridge Deck Widths for Four or More Lanes Divided Shoulder Approach and Curb and Gutter Approach

**Arterial System**  
**Bridge Deck Width**  
**Four or More Lanes - Divided**  
**Shoulder and Curb & Gutter Approach**

Single Structure - Shoulder Approach

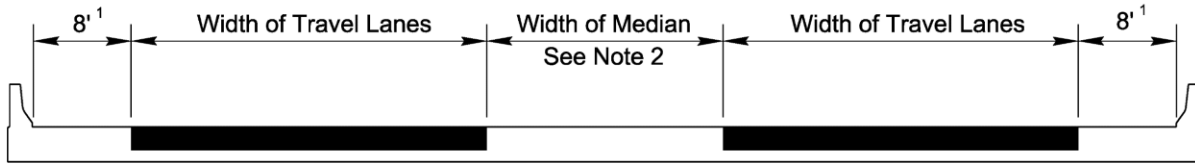

Dual Structure - Shoulder Approach

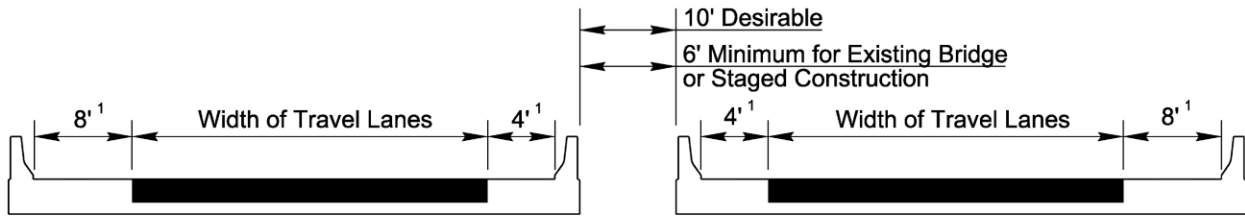

Single Structure - Curb and Gutter Approach<sup>3,4</sup>

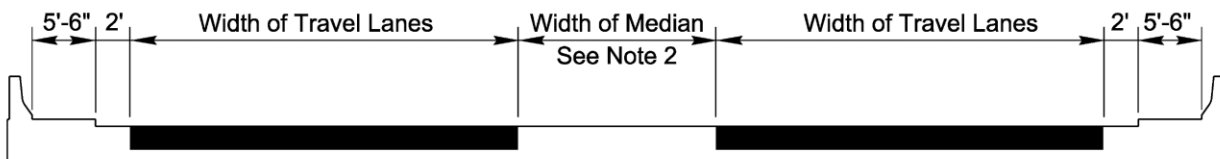

Dual Structure - Curb and Gutter Approach<sup>3,4</sup>

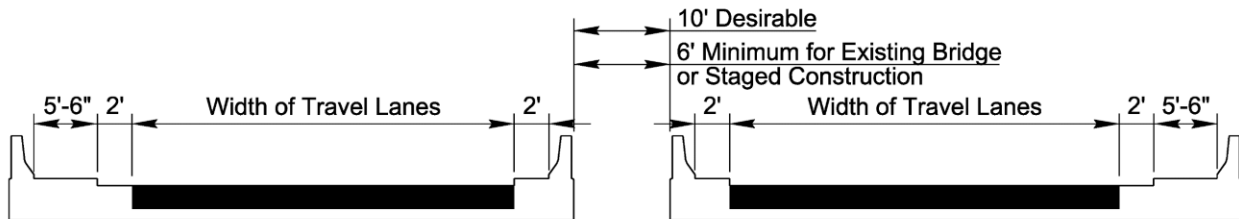

Legend

█ Through Travel Lanes

Notes:

1. 10' should be considered with six or more through lanes.
2. Review Section 5.3.2 in its entirety for additional information on medians across bridges.
3. Refer to Section 5.3.2.5 below for additional considerations on bridges with curb and gutter approaches.
4. Refer to Section 5.4 below for additional information on when to consider providing sidewalks on bridges.

Figure 5-5 Arterial System Bridge Deck Widths for Four or More Lanes Divided Shoulder Approach and Curb and Gutter Approach with Auxiliary Lanes

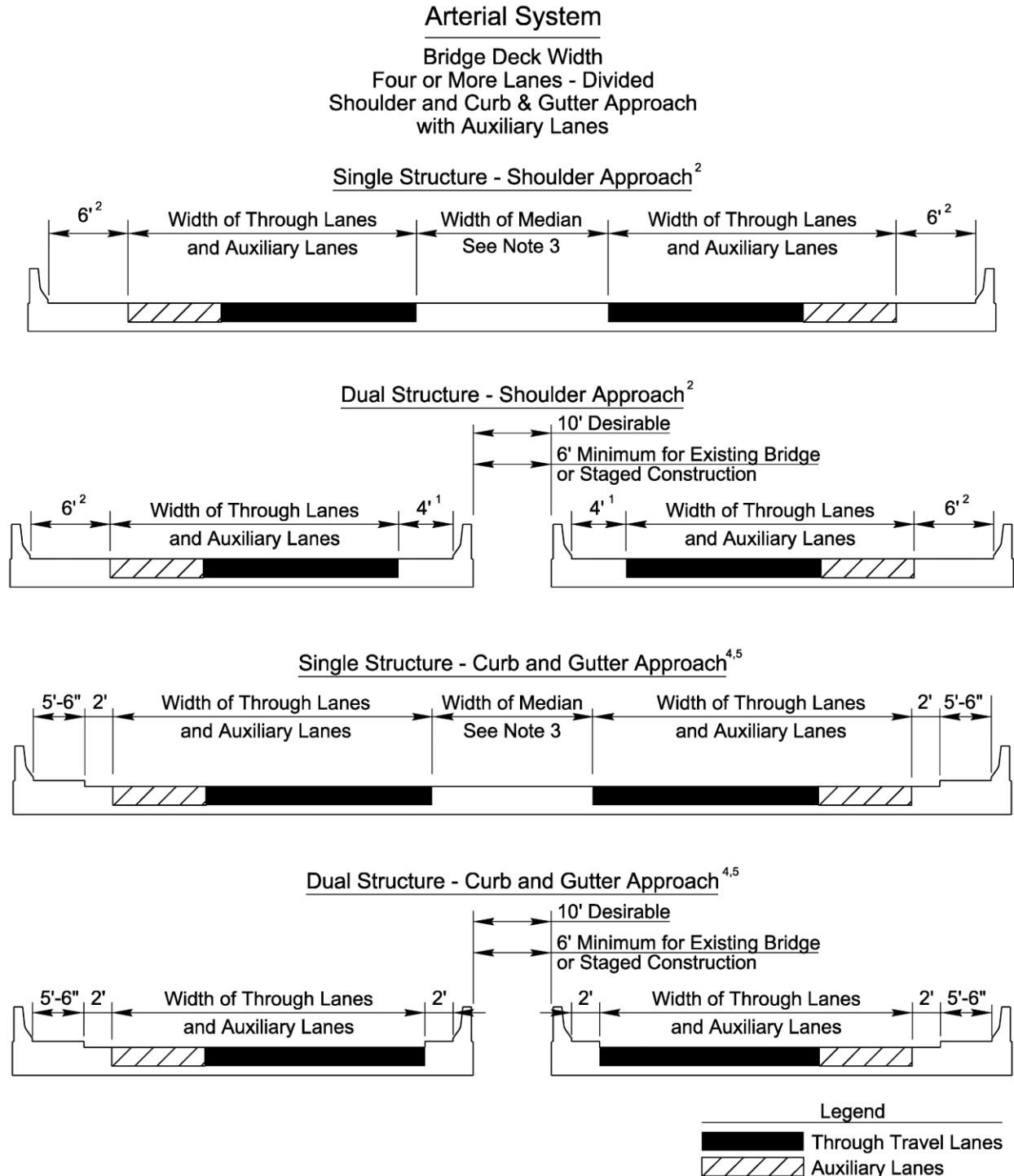

Notes:

1. 10' should be considered with six or more through lanes.
2. The offset for bridges within the urban area boundary may be increased to a minimum of 7'-6" to accommodate future sidewalks.
3. Review Section 5.3.2 in its entirety for additional information on medians across bridges.
4. Refer to Section 5.3.2.5 below for additional considerations on bridges with curb and gutter approaches.
5. Refer to Section 5.4 below for additional information on when to consider providing sidewalks on bridges.

Figure 5-6 Arterial System Bridge Deck Widths for Four or More Lanes Undivided

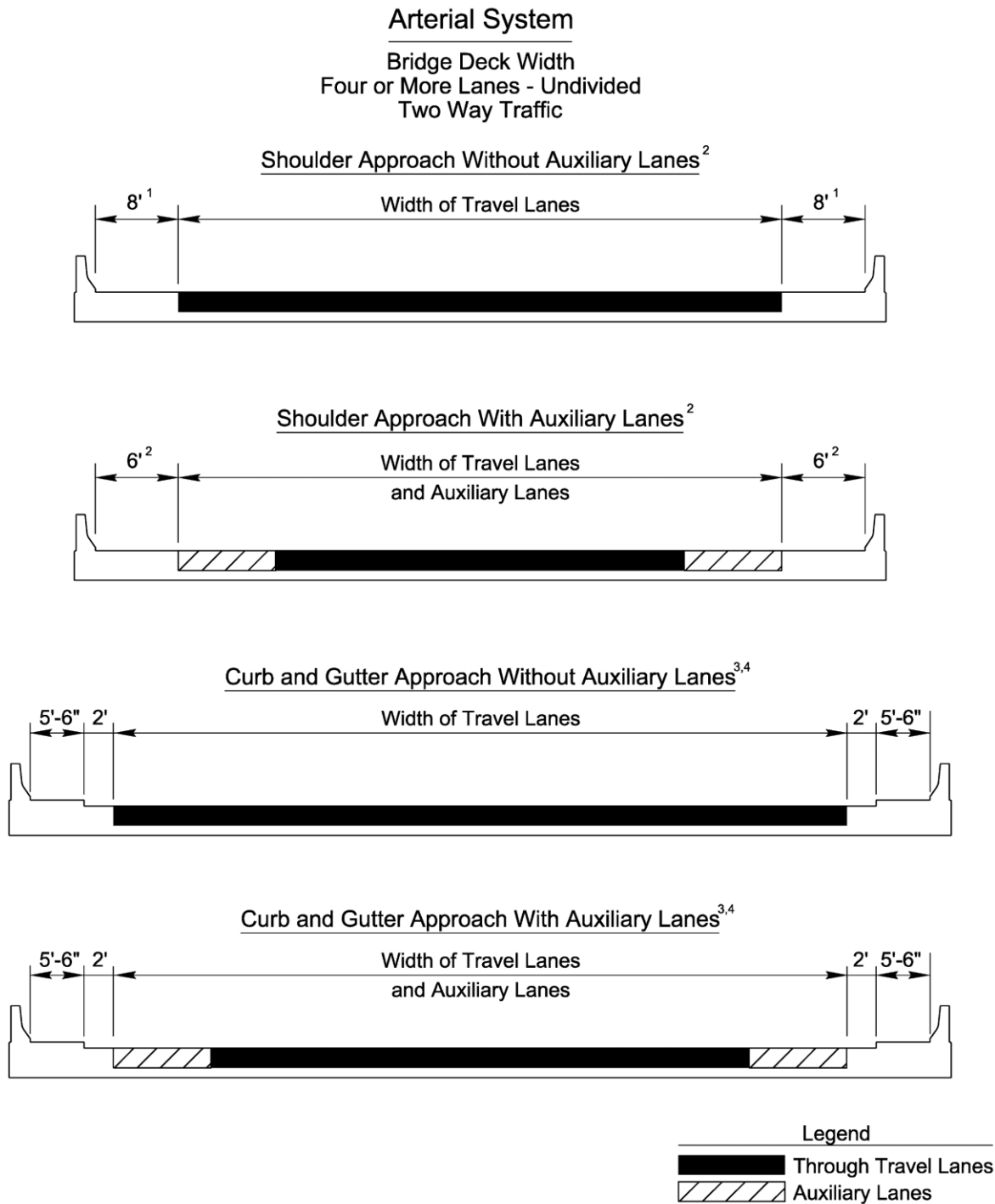

Notes:

1. 10' should be considered with six or more through lanes or ADT < 40,000.
2. The offset for bridges within the urban area boundary may be increased to a minimum of 7'-6" to accommodate future sidewalks.
3. Refer to Section 5.3.2.5 below for additional considerations on bridges with curb and gutter approaches.
4. Refer to Section 5.4 below for additional information on when to consider providing sidewalks on bridges.

Figure 5-7 Collector Roads and Streets Bridge Deck Widths for Two-Lane Two-Way Traffic

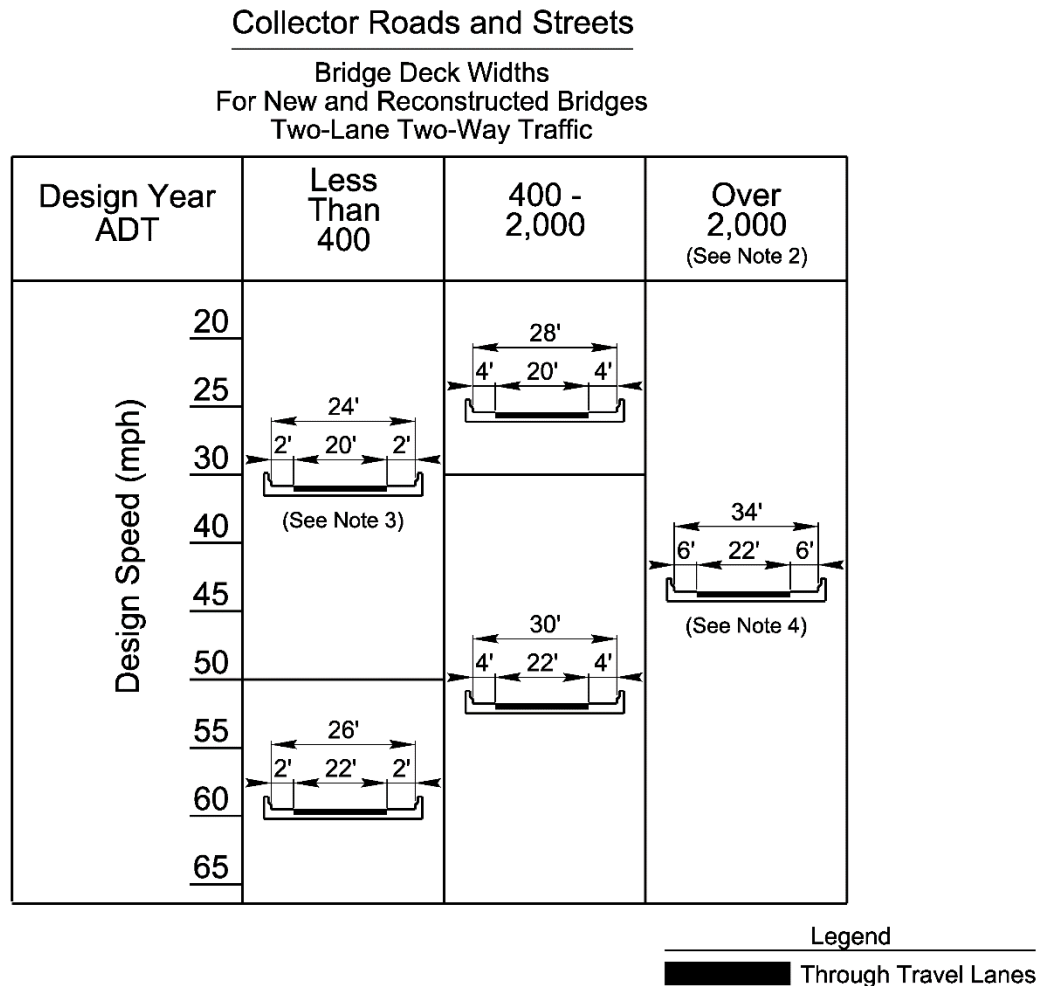

Notes:

1. The width of traveled way may remain at 22' on reconstructed highways where alignment and safety records are satisfactory.
2. For bridges in excess of 100' in length, the minimum width of traveled way plus 3' on each side is acceptable.
3. An 18' minimum width may be used for roadways with ADT < 250 and speed of 40 mph or less.
4. With speeds of 55 mph or greater, consider using lane width of 24' where substantial truck volumes are present or agricultural equipment frequently uses the road.
5. Bridge deck width charts are based on design year ADT. If only current ADT is available, design year ADT should be obtained from the traffic forecasting unit of the statewide planning branch.
6. Where the approach roadway width (traveled way plus shoulder) is surfaced, that surface width shall be carried across all structures. For bridges in excess of 100', see Note 2.
7. Refer to GB Chapter 3 for curve widening consideration.
8. The offset for bridges within the urban area boundary may be increased to a minimum of 7'-6" to accommodate future sidewalks. The engineer should check with the hydraulics unit to determine if additional offset is needed to accommodate for drainage.
9. Refer to Section 5.3.2.5 below for additional considerations on bridges with curb and gutter approaches.
10. When auxiliary lanes are required, add their width to the width of the travel lanes.
11. Minimum shoulder widths of 6' are desired for structures which are located at interchanges. The minimum values shown above may be used if the required sight distance can be achieved.



Figure 5-8 Local Roads and Streets Bridge Deck Widths

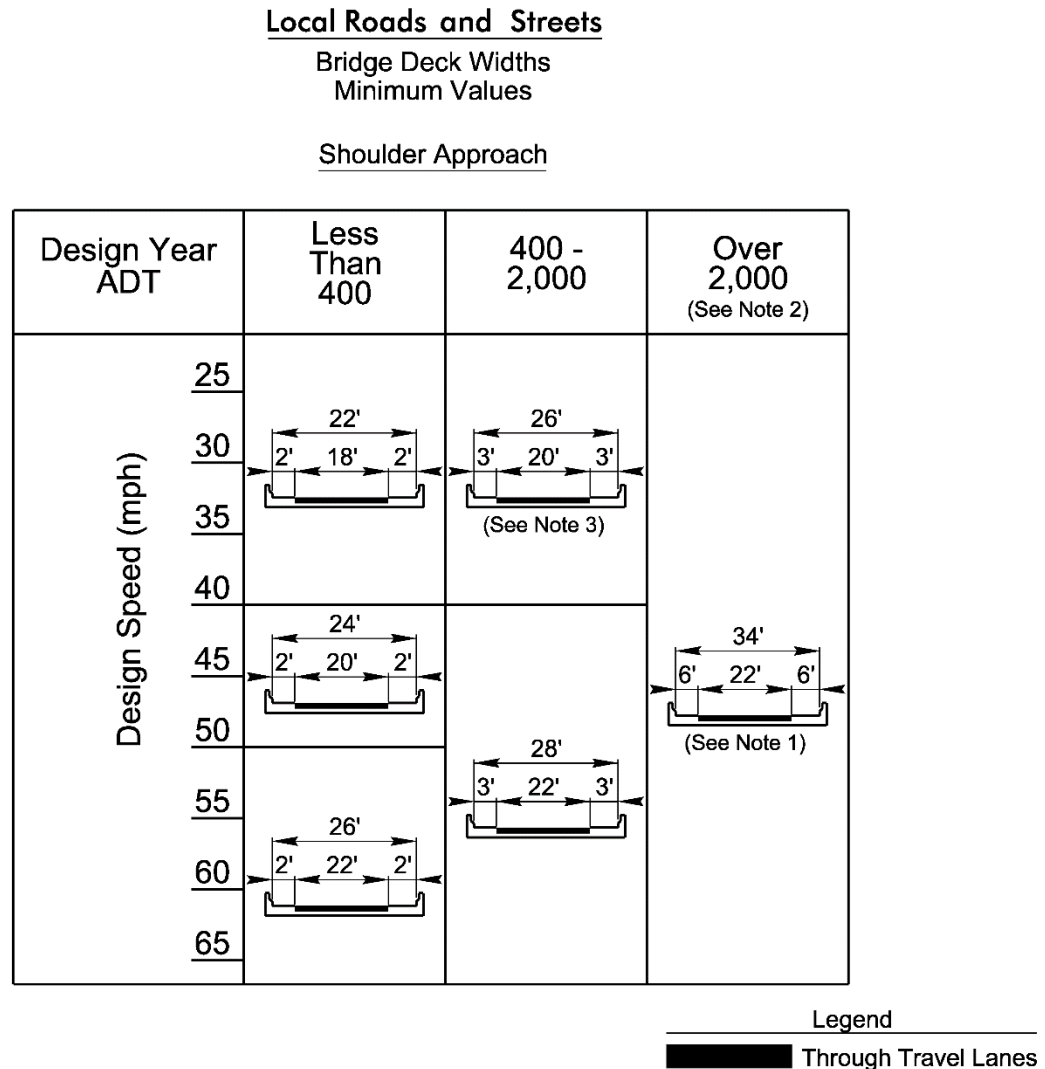

Notes:

1. The width of traveled way may remain at 22' on reconstructed highways where alignment and safety records are satisfactory.
2. For bridges in excess of 100' in length, the minimum width of traveled way plus 3' on each side is acceptable.
3. For mountainous terrain and having an ADT between 400 and 600 the use of 18' width and 2' shoulders is acceptable. Refer to GB Chapter 5.
4. With speeds of 55 mph or greater, consider using lane width of 24' where substantial truck volumes are present or agricultural equipment frequently uses the road.
5. Bridge deck width charts are based on design year ADT. If only current ADT is available, design year ADT should be obtained from the traffic forecasting unit of the statewide planning branch.
6. Where the approach roadway width (traveled way plus shoulder) is surfaced, that surface width shall be carried across all structures. For bridges in excess of 100', see Note 2.
7. Refer to GB Chapter 3 for curve widening consideration.
8. The offset for bridges within the urban area boundary may be increased to a minimum of 7'-6" to accommodate future sidewalks. The engineer should check with the hydraulics unit to determine if additional offset is needed to accommodate for drainage.
9. Refer to Section 5.3.2.5 below for additional considerations on bridges with curb and gutter approaches.
10. When auxiliary lanes are required, add their width to the width of the travel lanes.
11. Minimum shoulder widths of 6' are desired for structures which are located at interchanges. The minimum values shown above may be used if the required sight distance can be achieved.

Figure 5-9 Local and Collector System Bridge Deck Widths for Four or More Lanes Divided

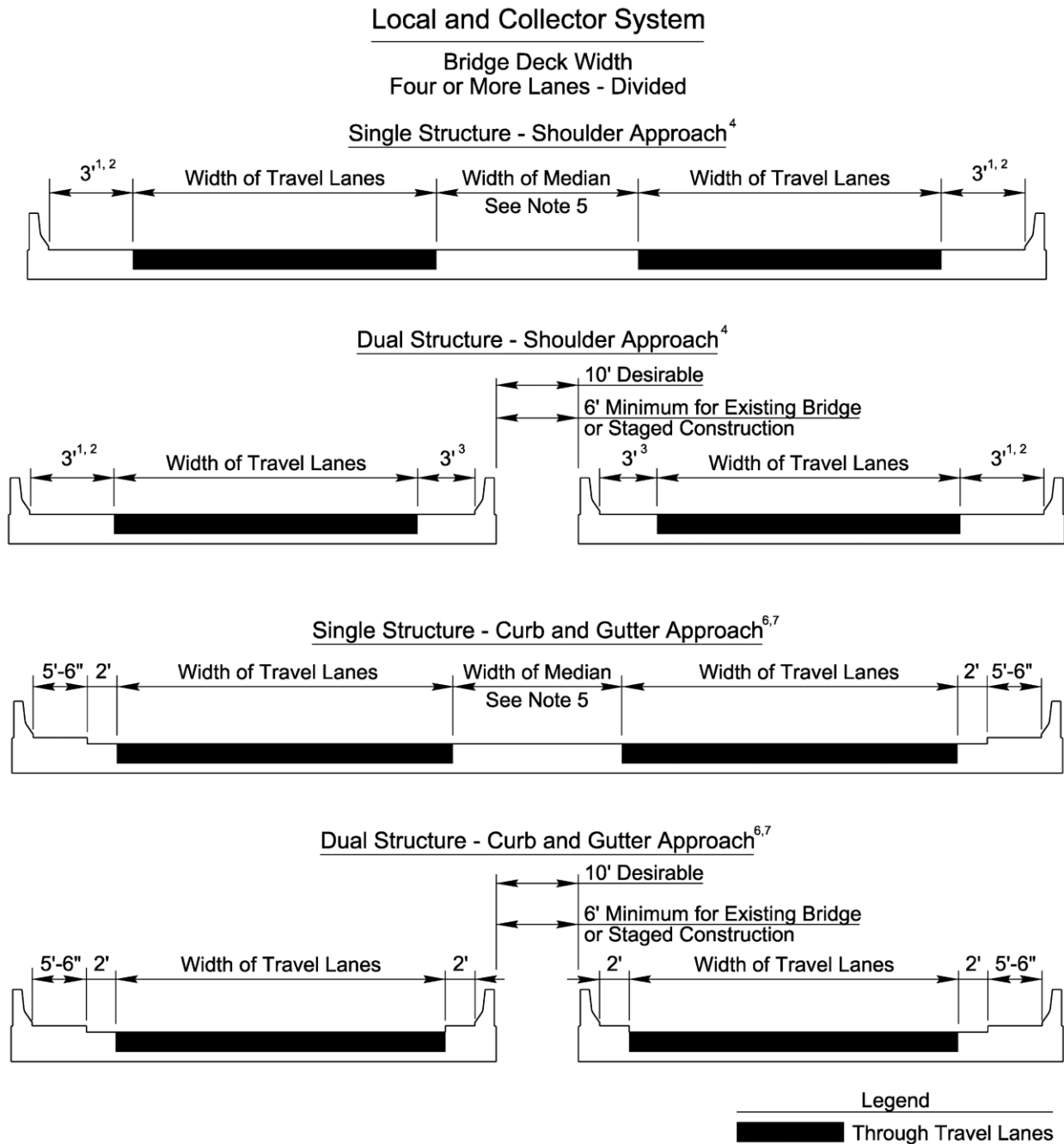

Notes:

1. Minimum shoulder widths of 6' are desired for structures which are located at interchanges. The minimum values shown above may be used if the required sight distance can be achieved.
2. For structures of 100' or less in length and having ADT over 2,000 use 6' shoulders.
3. For structures of 100' or less in length and having ADT over 8,000 use 4' shoulders.
4. The offset for bridges within the urban area boundary may be increased to a minimum of 7'-6" to accommodate future sidewalks.
5. Review Section 5.3.2 in its entirety for additional information on medians across bridges.
6. Refer to Section 5.3.2.5 below for additional considerations on bridges with curb and gutter approaches.
7. Refer to Section 5.4 below for additional information on when to consider providing sidewalks on bridges.

Figure 5-10 Local and Collector System Bridge Deck Widths for Four or More Lanes Divided with Auxiliary Lanes

Local and Collector System

Bridge Deck Width  
Four or More Lanes - Divided  
With Auxiliary Lanes

Single Structure - Shoulder Approach<sup>4</sup>

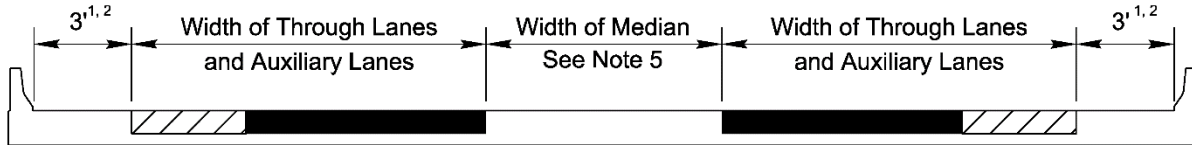

Dual Structure - Shoulder Approach<sup>4</sup>

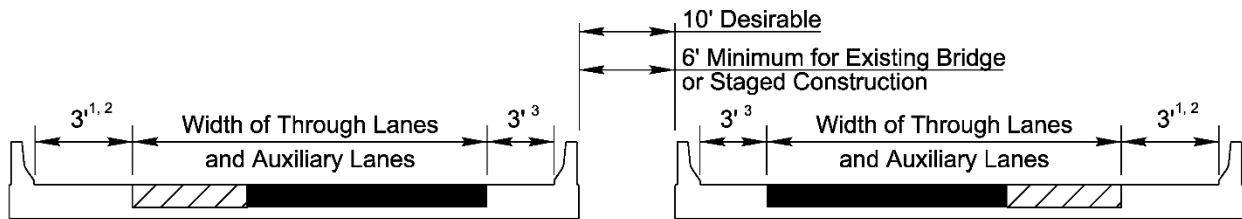

Single Structure - Curb and Gutter Approach<sup>6,7</sup>

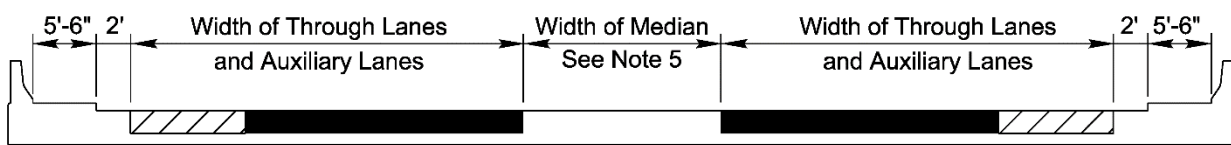

Dual Structure - Curb and Gutter Approach<sup>6,7</sup>

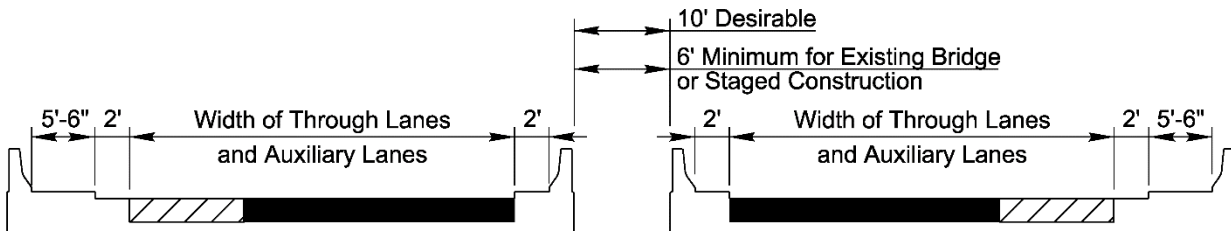

Legend

- Through Travel Lanes
- Auxiliary Lanes

Notes:

1. Minimum shoulder widths of 6' are desired for structures which are located at interchanges. The minimum values shown above may be used if the required sight distance can be achieved.
2. For structures of 100' or less in length and having ADT over 2,000 use 6' shoulders.
3. For structures of 100' or less in length and having ADT over 8,000 use 4' shoulders.
4. The offset for bridges within the urban area boundary may be increased to a minimum of 7'-6" to accommodate future sidewalks.
5. Review Section 5.3.2 in its entirety for additional information on medians across bridges.
6. Refer to Section 5.3.2.5 below for additional considerations on bridges with curb and gutter approaches.
7. Refer to Section 5.4 below for additional information on when to consider providing sidewalks on bridges.

Figure 5-11 Local and Collector System Bridge Deck Widths for Four or More Lanes Undivided Two-Way Traffic

Local and Collector System

Bridge Deck Width  
Four or More Lanes - Undivided  
Two Way Traffic

Shoulder Approach Without Auxiliary Lanes<sup>3</sup>

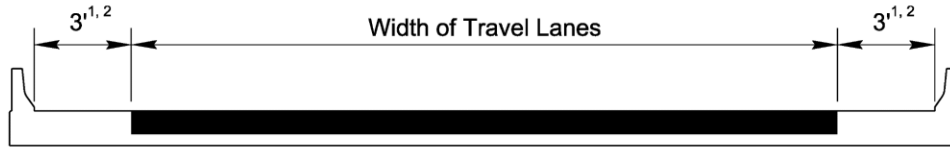

Shoulder Approach With Auxiliary Lanes<sup>3</sup>

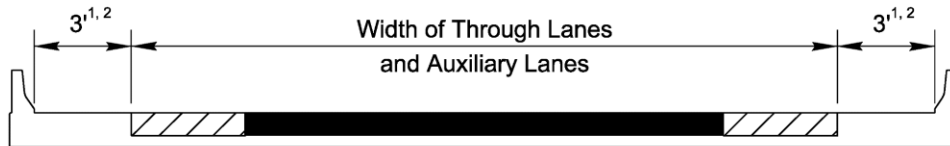

Curb and Gutter Approach Without Auxiliary Lanes<sup>4,5</sup>

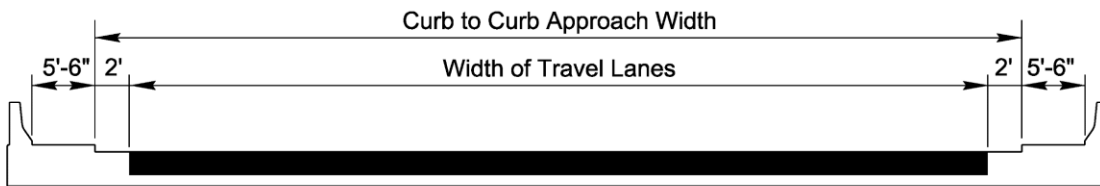

Curb and Gutter Approach With Auxiliary Lanes<sup>4,5</sup>

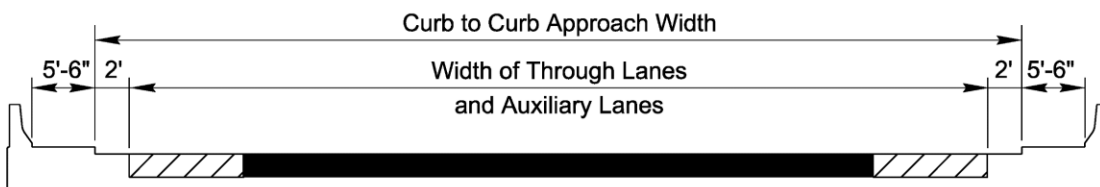

Legend

- Through Travel Lanes
- Auxiliary Lanes

Notes:

1. Minimum shoulder widths of 6' are desired for structures which are located at interchanges. The minimum values shown above may be used if the required sight distance can be achieved.
2. For structures of 100' or less in length and having ADT over 2,000 use 6' shoulders.
3. The offset for bridges within the urban area boundary may be increased to a minimum of 7'-6" to accommodate future sidewalks.
4. Refer to Section 5.3.2.5 below for additional considerations on bridges with curb and gutter approaches.
5. Refer to Section 5.4 below for additional information on when to consider providing sidewalks on bridges.

Figure 5-12 One Way Ramp Bridge Deck Widths

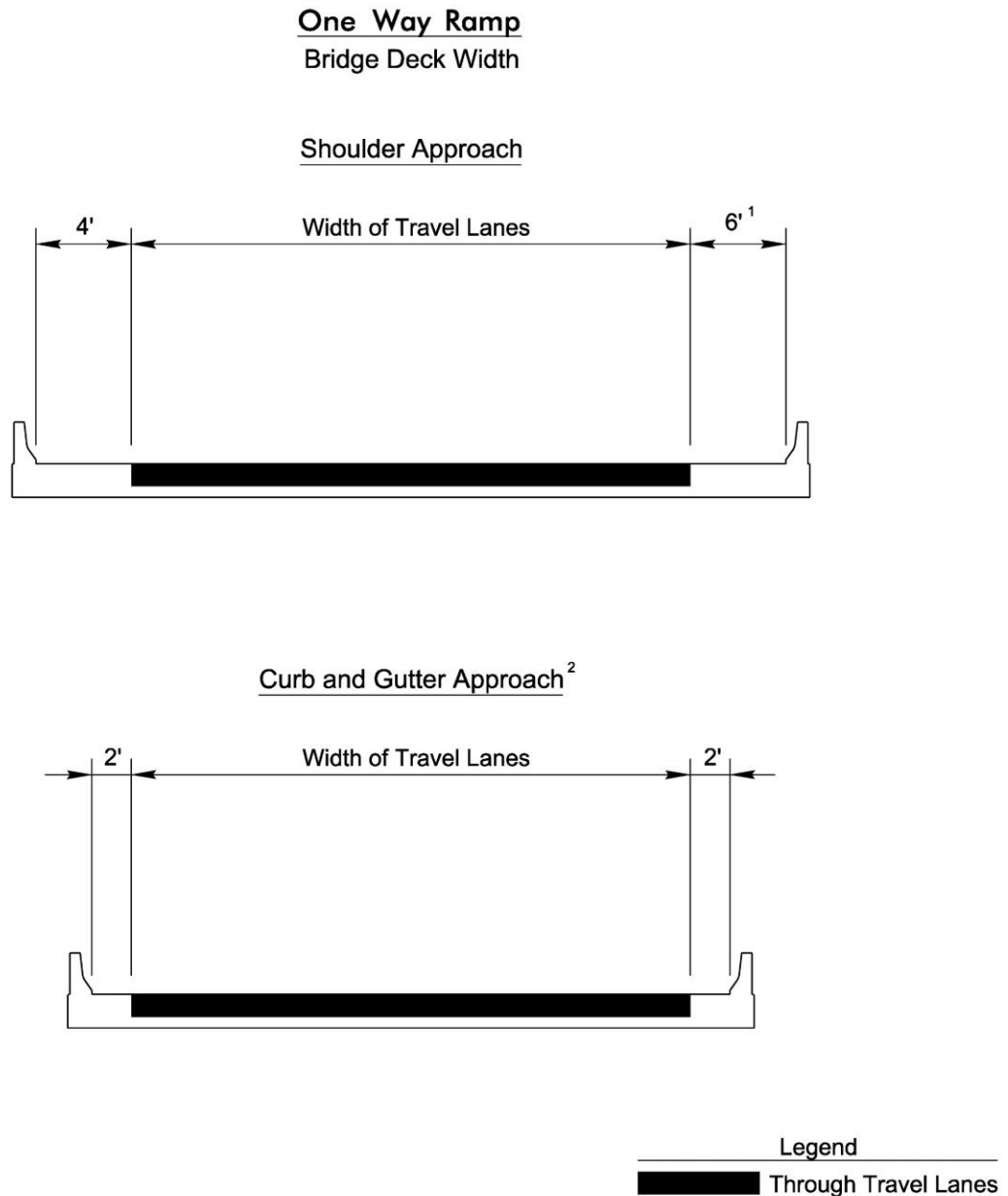

## Notes:

1. Use 10' for directional interchange ramps. On directional interchange ramps it is acceptable to switch the widened offset to the inside of the curve when needed for horizontal sight distance. Widening should not exceed 12 feet. Any width over 12' needed to achieve sight distance and avoid a design exception can be coordinated during the design exception evaluation process.
2. Curb and gutter should be considered only to facilitate particularly difficult drainage situations. Curb and gutter is not recommended on intermediate or directional ramps, except in special cases.
3. Refer to GB Chapter 10 for additional information.

Note that the 2-foot gutter widths shown in these guidelines assume the use of standard 2'-6" curb and gutter details. If other curb and gutter details are used, adjust bridge widths accordingly.

### 5.3.2.2 Single versus Dual Bridges

On a divided highway, coordinate with the Project Manager, Structures Lead, and Work Zone Traffic Control (WZTC) Project Design Engineer during PDN Activities 2RD1, 2TM2, and 2ST1 to determine whether to provide dual, separate structures or a single structure. Consider bridge constructability and future bridge inspection access. Generally, the Structures Management Unit prefers dual, separate bridges when the clear space in the median between the edges of the bridge decks is wide enough to facilitate future bridge inspections. Ideally, the clear median between structures should be wide enough to allow access by under bridge inspection devices (also known as snoopers); however, in cases where other means of access are possible, a narrower clear median width may be acceptable. Consider the concept temporary traffic control plans; the phasing of construction and associated traffic shifts may suggest advantages to the use of a single structure or dual, separate structures.

If a single structure is proposed, show the raised median or median barrier width in the DRPS. From a geometry and design perspective, ~~it is~~ **is it** most desirable to provide a uniform median width and a single vertical alignment through the roadway approaches and along the structure.

If dual, separate bridges are proposed, previous value engineering exercises suggest that providing independent alignments and independent vertical profiles (also known as bifurcated profiles) allows flexibility for optimizing earthwork, retaining walls, vertical clearances, maintenance of existing pavement, and structure type and size.

In some cases, local adjustments to the horizontal or vertical alignments at bridges (including widening or narrowing of median offsets) may allow for structure designs that are safer, easier, and/or more economical to build and maintain. Coordinate with the Project Manager, Structures Lead, WZTC Project Design Engineer, Area Construction Engineer, and Division staff when considering local horizontal or vertical alignments at bridges. Consider current, proposed, and future conditions when making such evaluations.

### 5.3.2.3 Raised Islands on Bridges

Coordinate with the Structures Lead during PDN Activity 2RD1 to determine if a raised island is required on a bridge. When raised islands are required, use only mountable island types. Section 6.2.5 of the [NCDOT Structures Management Unit Manual](#) and [NCDOT Roadway Standard Drawings](#) Std. No. 852.01 include standard details for standard mountable islands (also known as permanent concrete median strips) on bridge decks. Detail islands in the DRPS.

### 5.3.2.4 Median Barriers

Coordinate with the project team during PDN Activity 2RD1 to determine if a median barrier is required on the bridge. ~~Provide a concrete median barrier in these situations:~~

~~Single structures on controlled access facilities regardless of design speed~~

~~Single structures on non-controlled divided facilities with design speeds greater than 50 mph~~

~~Where the approach roadway has a concrete median barrier, continue the same type of barrier across the structure. If there is no concrete median barrier on the approach roadway, provide the standard concrete median barrier recommended in Figures 6-27 and 6-28 of the NCDOT Structures Management Unit Manual; locate the ends of barrier at the ends of approach slab and provide appropriate safety end treatments.~~

### 5.3.2.5 Special Criteria for Facilities with Sidewalks, Bikeways, Shared-Use Paths

Design the clear width for new bridges on streets with curb and gutter approaches to match the curb-to-curb approach width except where bikeways are carried across the structure. For projects involving bikeways, determine the required clear width on a case-by-case basis.

Determine bridge deck widths during PDN Activity 2RD1 based on the functional classification, traffic conditions (ADT), and the widths and types of lanes of the roadway being carried by the bridge.

## 5.3.3 Horizontal Clearances for Bridges

Horizontal clearance requirements under a highway bridge affect bridge span lengths and total length. Identify the minimum horizontal clearance requirements for the feature or features being crossed by the bridge.

### 5.3.3.1 Bridges over Roadways

Determine horizontal clearance requirements for bridges crossing existing or proposed roadways during PDN Activity 2RD1 based on the functional classification, traffic conditions (ADT), and the widths and types of lanes of the roadway or roadways under the bridge. Coordinate with the Project Manager, Structures Lead, Congestion Management Project Design Engineer, NEPA/SEPA Lead, and appropriate Division staff to consider accommodating future widening of the roadway under the bridge. Any provisions for future widening other than those contained in the approved environmental documents prepared in PDN Activity 2EP1 shall require approval by the Project Manager and the Division Engineer. The typical sections under the bridge should reflect the approved Design Criteria (PDN Activity 2RD1) and approved Traffic Analysis (PDN Activity 2TM1).

Refer to Figure 5-13 through Figure 5-18 for illustrations of the appropriate horizontal clearance requirements for bridges crossing Interstate highways, Freeways, Arterial System roads, Local and Collector roads, and Ramps.

When a ditch section is to be continued under a bridge, coordinate with the Structures Lead and the Hydraulic Design Engineer during PDN Activity 2RD1 and adjust the roadway typical section under the bridge as appropriate to avoid conflicts between ditches and interior bents. Ideally, provide 2-foot minimum clearance between the face of interior bent columns and the top of the ditch.

During PDN Activity 2RD1, the Structures Lead will evaluate the feasibility of the initial structure concept proposed by the roadway designer. The Structures Lead will determine the necessity for, and location of, interior bents, considering construction cost, maintenance cost, risk of accidents, potential for future widening (of both the bridge itself and the roadway underneath the bridge), and continuity of the typical section under the bridge. Provide input on these items to the Structures Lead as appropriate. If necessary, adjust the typical section under the bridge to accommodate interior bents or other structural features, with appropriate horizontal clearance provisions.

During PDN Activity 2RD1, coordinate with the Project Manager, Division Project Manager, Division Traffic Engineer, Division Project Development Engineer, Division Environmental Supervisor, and Division Planning Engineer to determine the necessity for providing sufficient lateral offset to allow for construction of future greenways, sidewalks, or trails. Depict such offsets in the typical section under the bridge so the Structures Lead can address these requirements when laying out the bridge.

Figure 5-13 Interstate or Freeway System Horizontal Clearances for Divided Traffic-



### Interstate System

Horizontal Clearances  
for Divided Traffic

#### Shoulder Approach

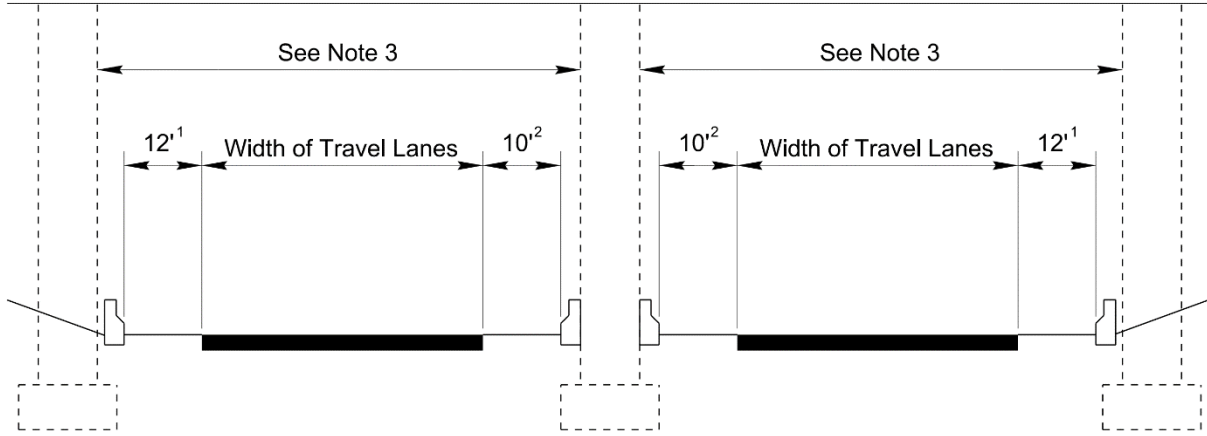

#### Shoulder Approach With Auxiliary Lanes

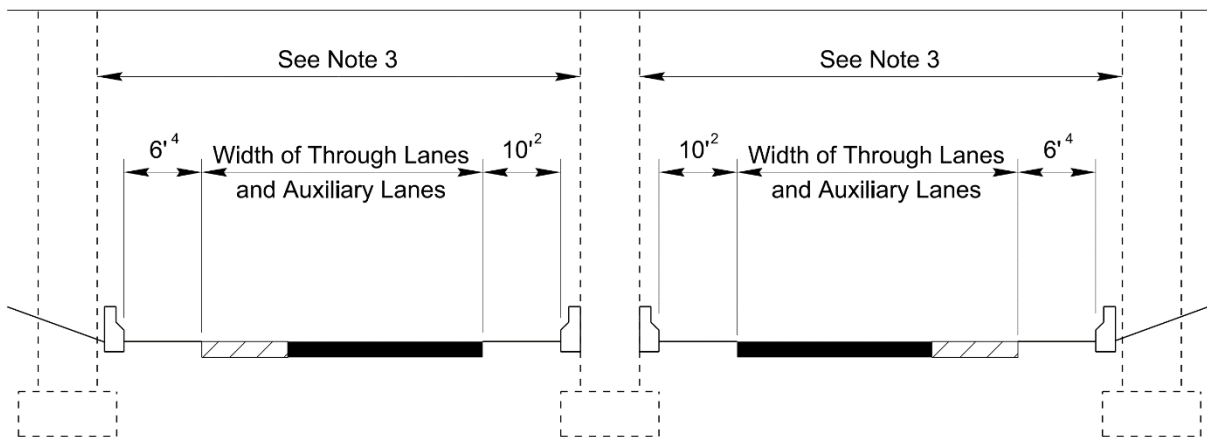

Legend

- Through Travel Lanes
- Auxiliary Lanes

## Interstate or Freeway System

### Horizontal Clearances for Divided Traffic

#### Shoulder Approach

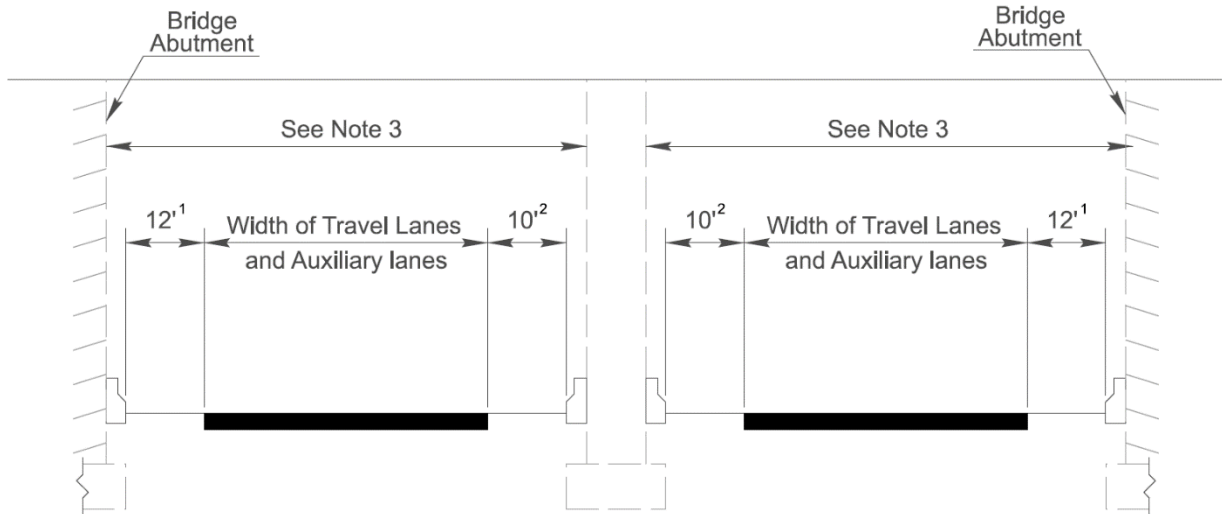

#### Notes:

1. Use 18' when design year ADT is greater than 50,000 to accommodate future auxiliary lanes of interchange ramps or loops.
2. Consider 12' when design year truck volumes are greater than 250 DDHV.
3. Refer to Section 5.3.3.1 above for other considerations when determining horizontal clearance requirements.
4. ~~Use 10' shoulder when auxiliary lane connects interchanges or an auxiliary lane is longer than 2,500'.~~ Use a minimum of 10' shoulder width at all locations for interstates and freeways.
5. Consider including an additional outside 12' width on any underpass with an abutment wall for future widening over the life-cycle of the bridge.

Figure 5-14 Freeway System Horizontal Clearances for Divided Traffic

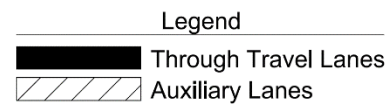
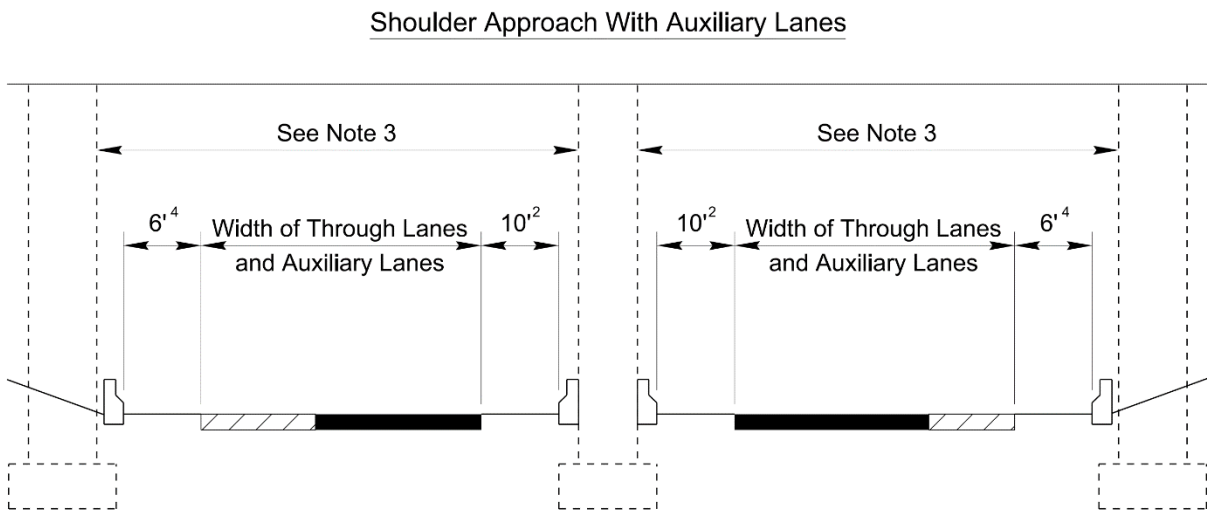
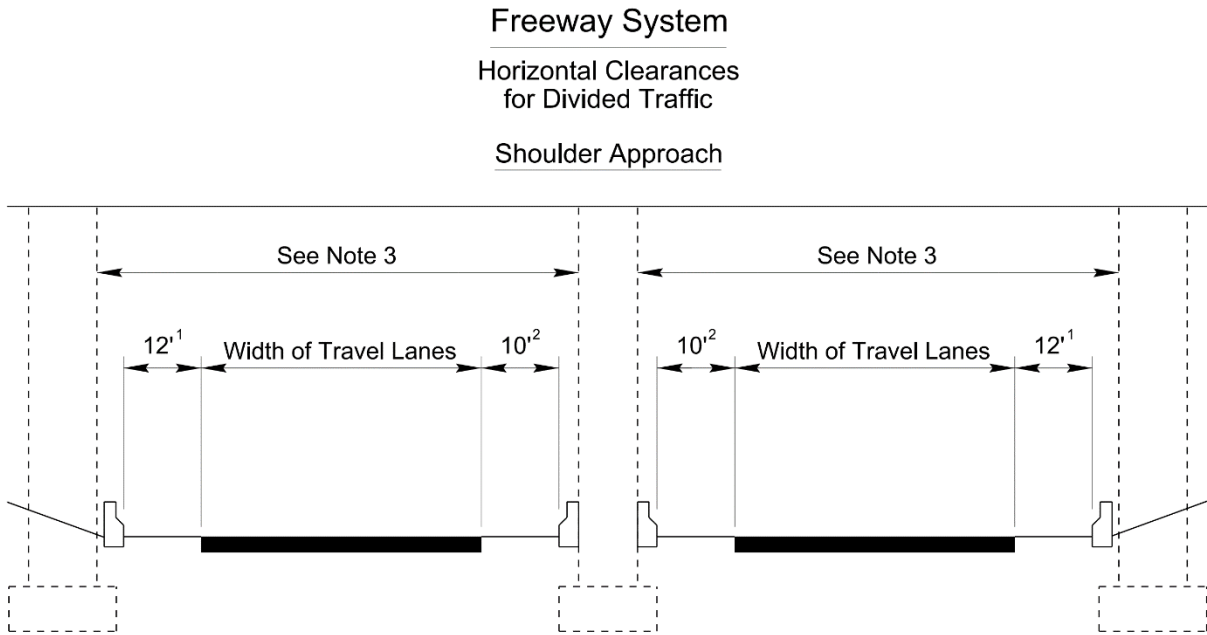

- Notes:
- 1.—Use 18' when design year ADT is greater than 50,000 to accommodate future auxiliary lanes of interchange ramps or loops.
  - 2.—Consider 12' when design year truck volumes are greater than 250 DDHV.
  - 3.—Refer to Section 5.3.3.1 above for other considerations when determining horizontal clearance requirements.
  - 4.—Use 10' shoulder when auxiliary lane connects interchanges or an auxiliary lane is longer than 2,500'.

Figure 5-14 Arterial System Horizontal Clearances for Undivided Traffic

### Arterial System

Horizontal Clearances  
for Undivided Traffic  
Two-Way Traffic

#### Shoulder Approach<sup>2</sup>

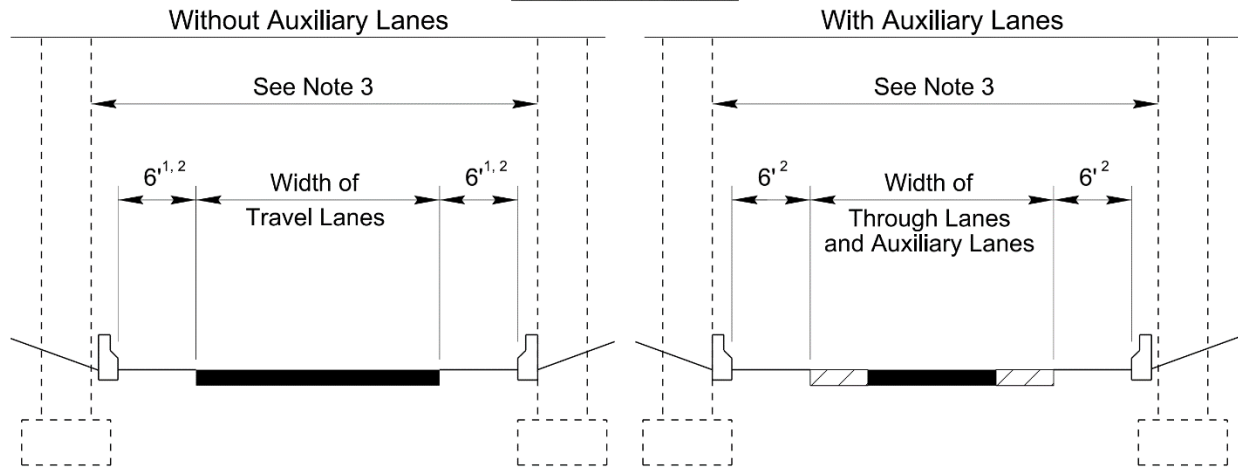

#### Curb and Gutter Approach<sup>4</sup>

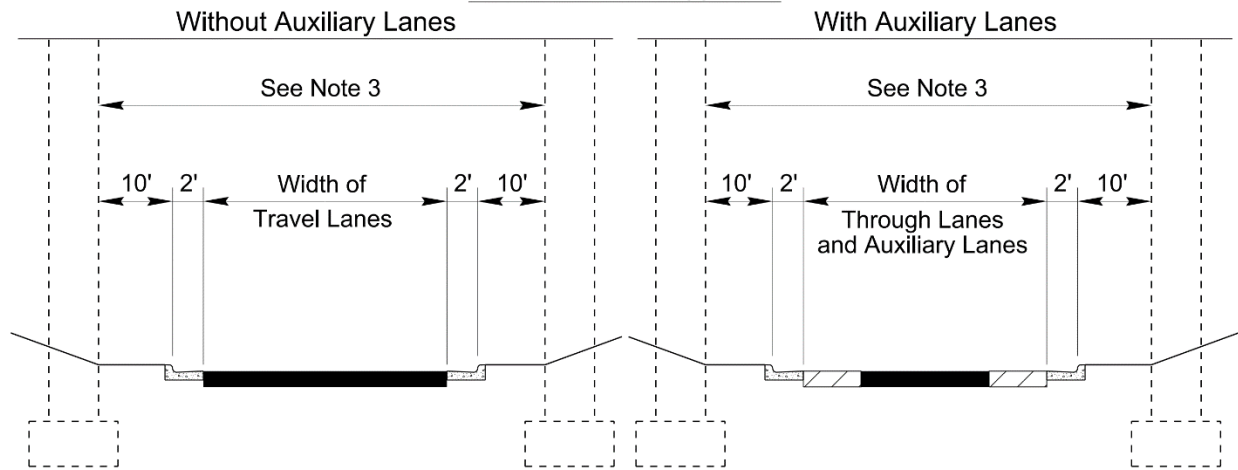

Legend

- Through Travel Lanes
- Auxiliary Lanes

### Arterial System

#### Horizontal Clearances for Undivided Traffic Two-Way Traffic

##### Shoulder Approach<sup>1</sup>

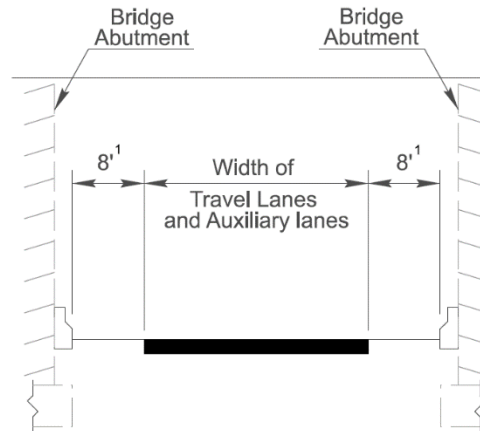

##### Curb and Gutter Approach<sup>3</sup>

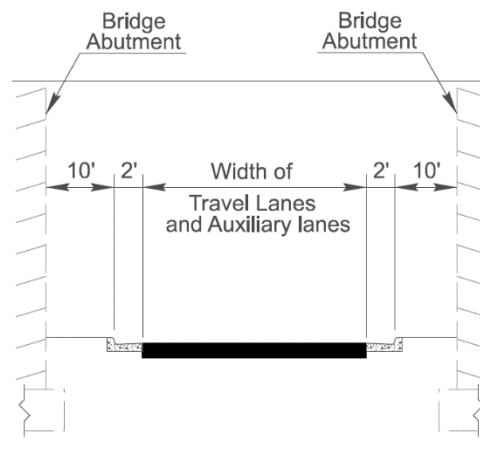

#### Notes:

1. When design ADT is under 2,000 use 6' offset. When design ADT is 2,000 and over, use 8' offset. When design ADT is under 2,000, a minimum 6' offset can be used. Consider increasing the 6' to a minimum of 7'-6" to accommodate future sidewalks in urban areas. Engineer should check with the Hydraulics Unit to determine if additional offset is needed to accommodate for drainage.
2. The offset for bridges within the urban area boundary may be increased to a minimum of 7'-6" to accommodate future sidewalks. Engineer should check with the Hydraulics Unit to determine if additional offset is needed to accommodate for drainage.
3. Refer to Section 5.3.3.1 above for other considerations when determining horizontal clearance requirements.
3. Refer to Section 5.3.8 below for additional information on sidewalks and curb and gutter approaches. The presence of curb and gutter does not negate the need to provide protection when bridge piers are located within the clear zone.
4. Consider including an additional outside 12' width on any underpass with an abutment wall for future widening over the life-cycle of the bridge.

Figure 5-15 Arterial System Horizontal Clearances for Divided Traffic Shoulder Approach

### Arterial System

Horizontal Clearances  
for Divided Traffic  
Shoulder Approach

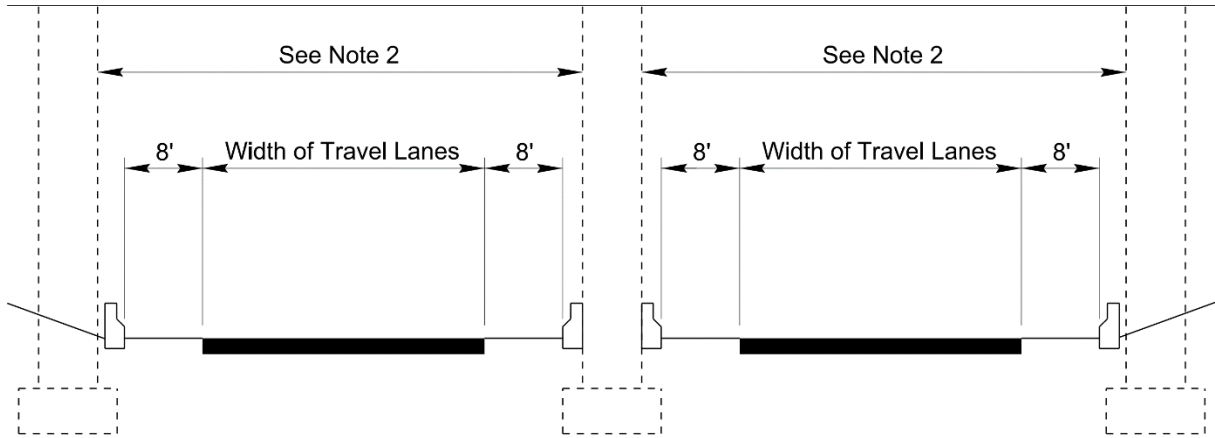

#### Without Auxiliary Lanes

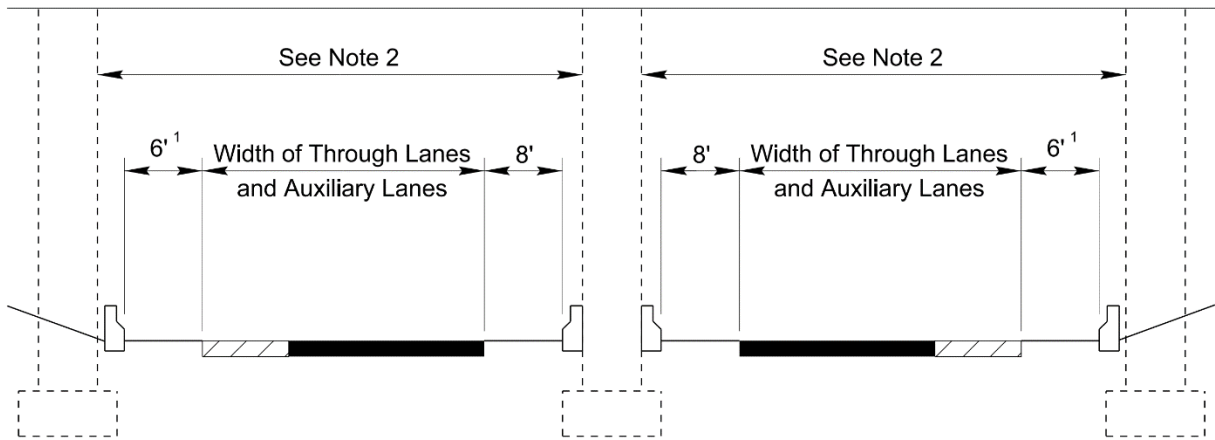

#### With Auxiliary Lanes

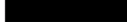

#### Legend

-  Through Travel Lanes
-  Auxiliary Lanes



**Arterial System**  
**Horizontal Clearances**  
**for Divided Traffic**  
**Shoulder Approach**

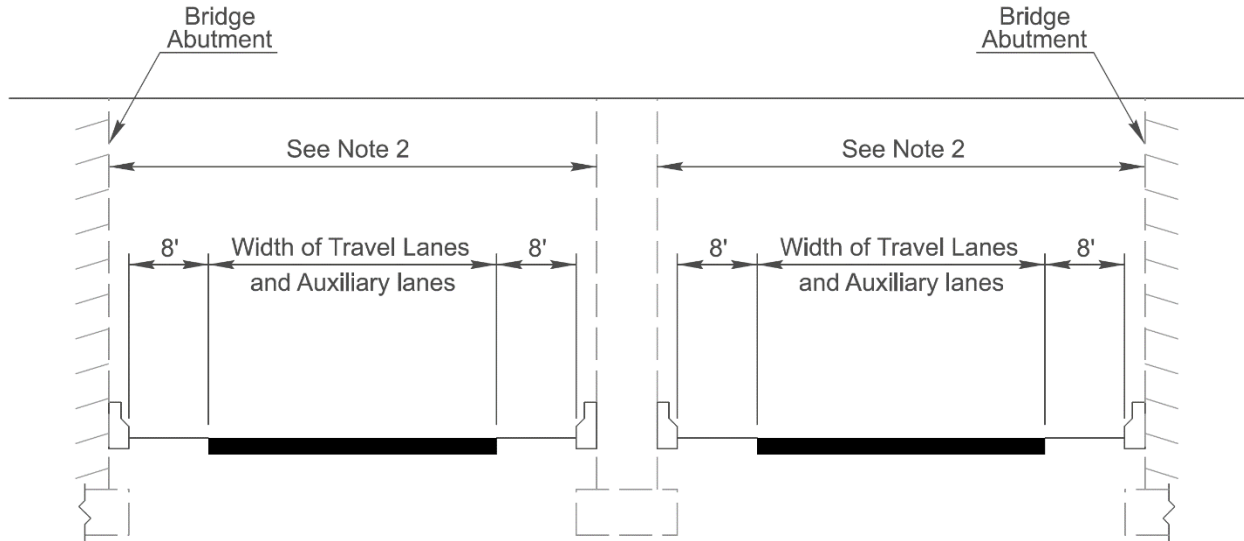

## Notes:

1. ~~The offset for bridges within the urban area boundary may be increased to a minimum of 7'-6" to accommodate future sidewalks. Engineer should check with the Hydraulics Unit to determine if additional offset is needed to accommodate for drainage.~~ In urban areas where future curb and gutter may be desirable, roadway designer should check with the Hydraulics Unit to determine if additional offset is needed to accommodate for drainage spread.
2. Refer to Section 5.3.3.1 above for other considerations when determining horizontal clearance requirements.
- 2.3. Consider including an additional outside 12' width on any underpass with an abutment wall for future widening over the life-cycle of the bridge.

Figure 5-16 Arterial System Horizontal Clearances for Divided Traffic Curb and Gutter Approach

### Arterial System

Horizontal Clearances  
for Divided Traffic  
Curb and Gutter Approach

#### Without Auxiliary Lanes

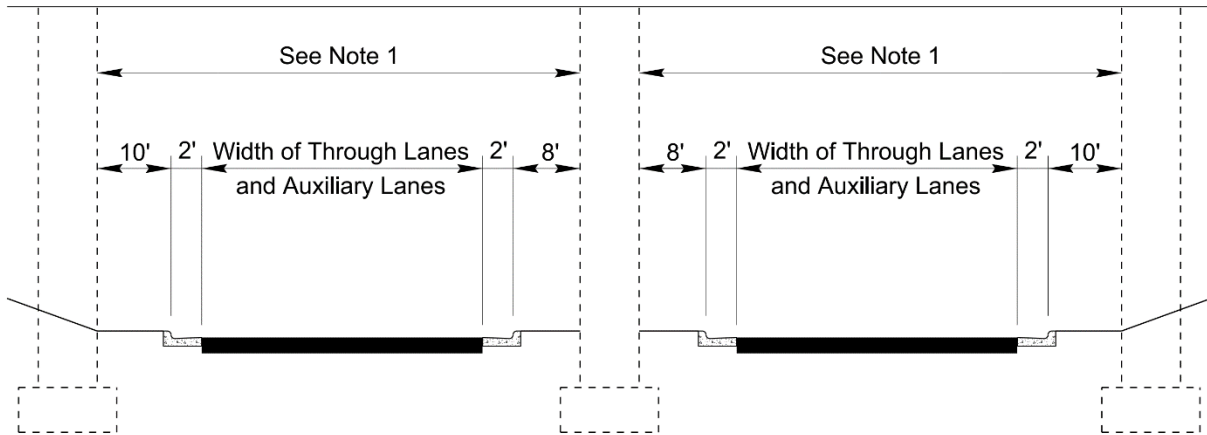

#### With Auxiliary Lanes

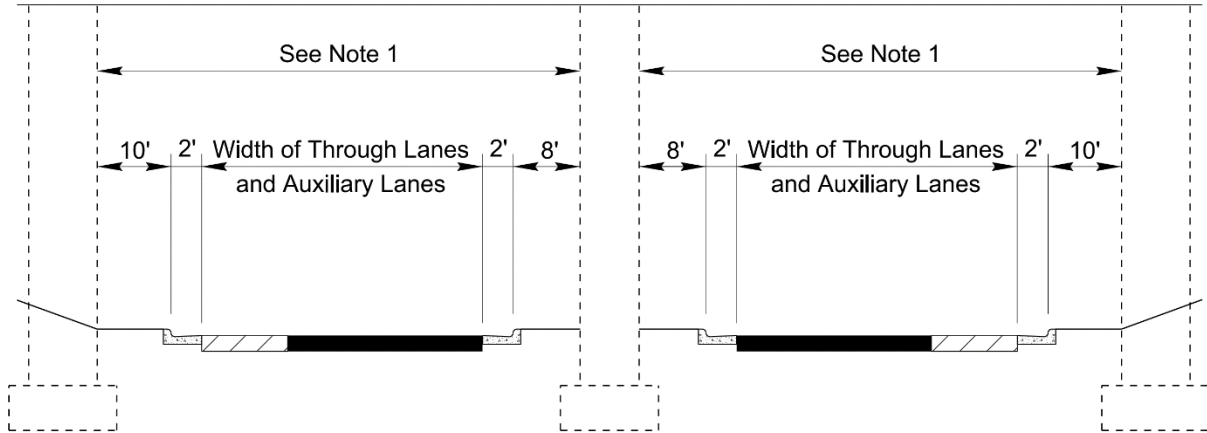

#### Legend

- Through Travel Lanes
- Auxiliary Lanes

**Arterial System**  
**Horizontal Clearances**  
**for Divided Traffic**  
**Curb and Gutter Approach**

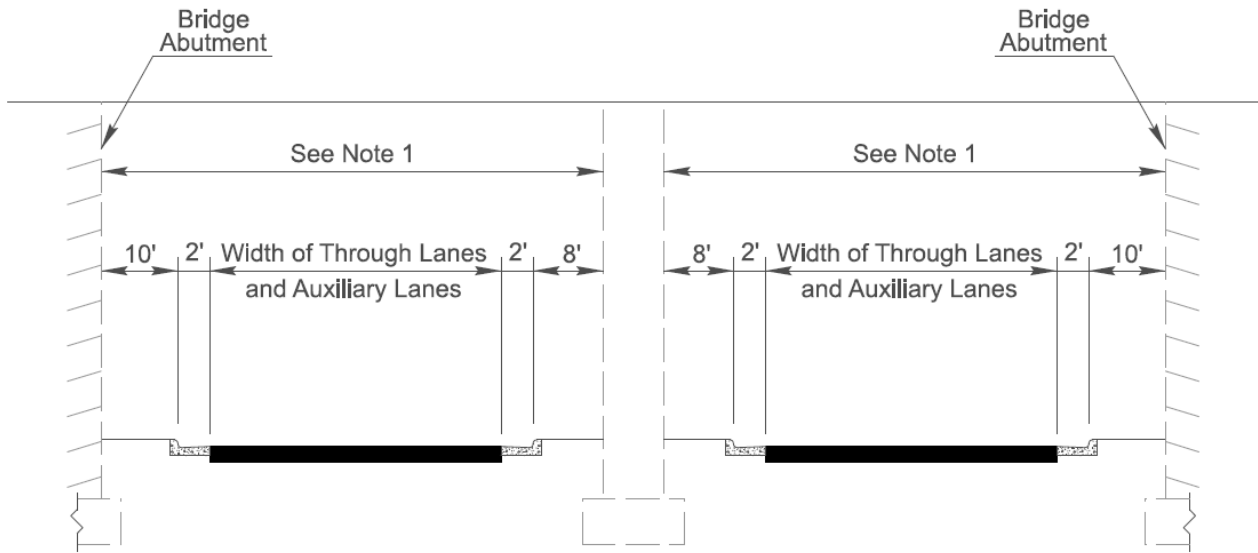

**Notes:**

1. Refer to Section 5.3.3.1 above for other considerations when determining horizontal clearance requirements.
2. Refer to Section 5.3.8 below for additional information on sidewalks and curb and gutter approaches. The presence of curb and gutter does not negate the need to provide protection when bridge piers are located within the clear zone.

Figure 5-17 Local and Collector System Horizontal Clearances for Design Year ADT

### Local and Collector System

Horizontal Clearances  
Design Year ADT

#### Shoulder Approach

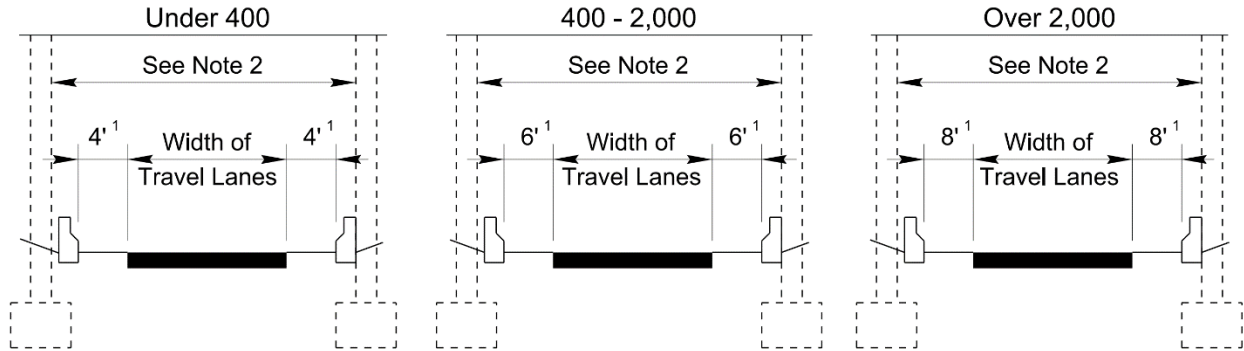

#### Shoulder Approach With Auxiliary Lanes

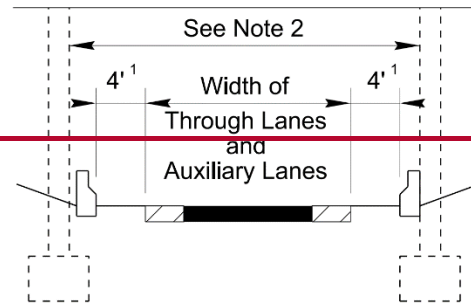

#### Curb and Gutter Approach<sup>3</sup>

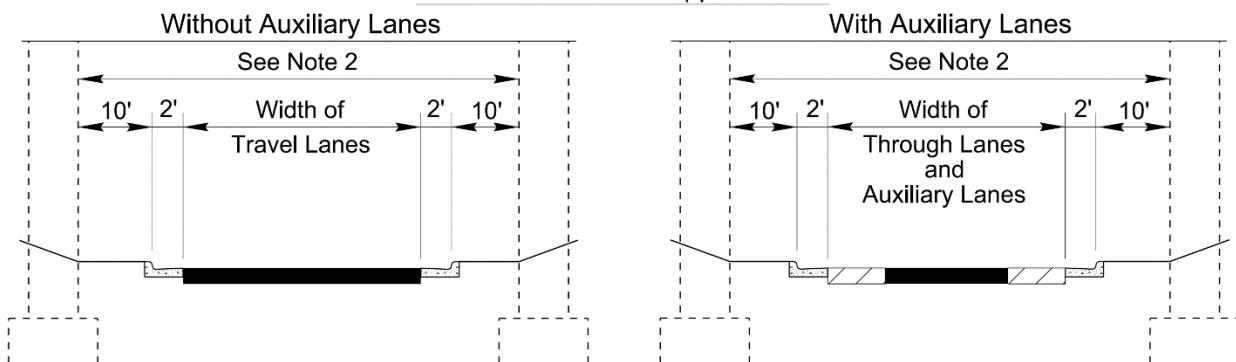

#### Legend

- Through Travel Lanes
- Auxiliary Lanes

### Local and Collector System

Horizontal Clearances  
Design Year ADT

#### Shoulder Approach

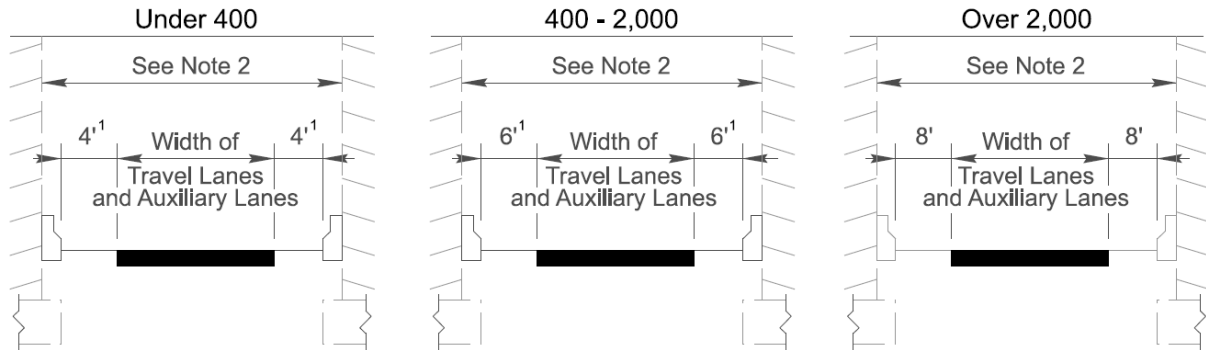

#### Curb and Gutter Approach<sup>3</sup>

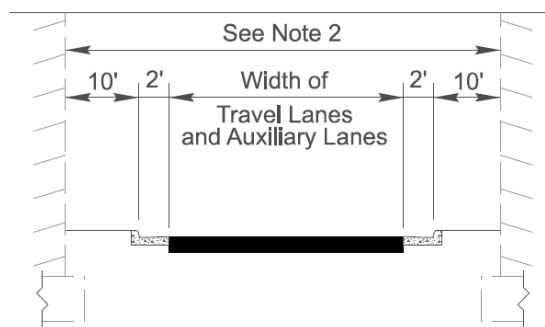

Notes:

1. The offset for bridges within the urban area boundary may be increased to a minimum of 7'-6" to accommodate future sidewalks. Engineer should check with the Hydraulics Unit to determine if additional offset is needed to accommodate for drainage.
2. Refer to Section 5.3.3.1 above for other considerations when determining horizontal clearance requirements.
3. Refer to Section 5.3.8 below for additional information on sidewalks and curb and gutter approaches. The presence of curb and gutter does not negate the need to provide protection when bridge piers are located within the clear zone.

Figure 5-18 One Way Ramp Horizontal Clearances

One-Way Ramp  
Horizontal Clearances

Shoulder Approach

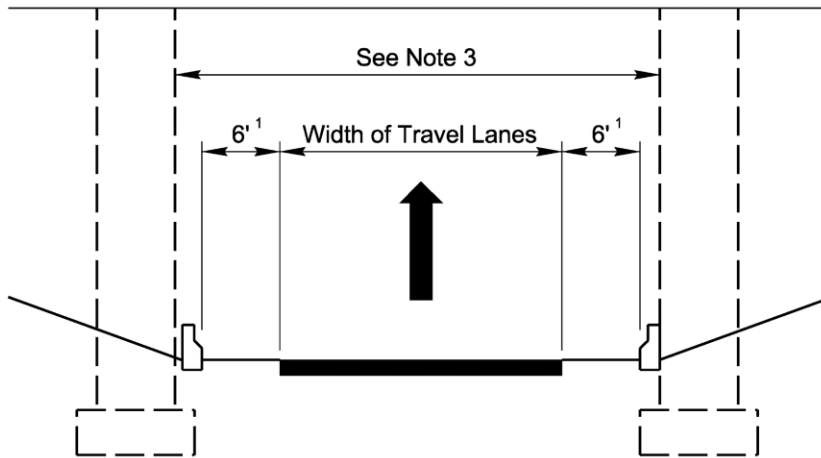

Curb and Gutter Approach<sup>2</sup>

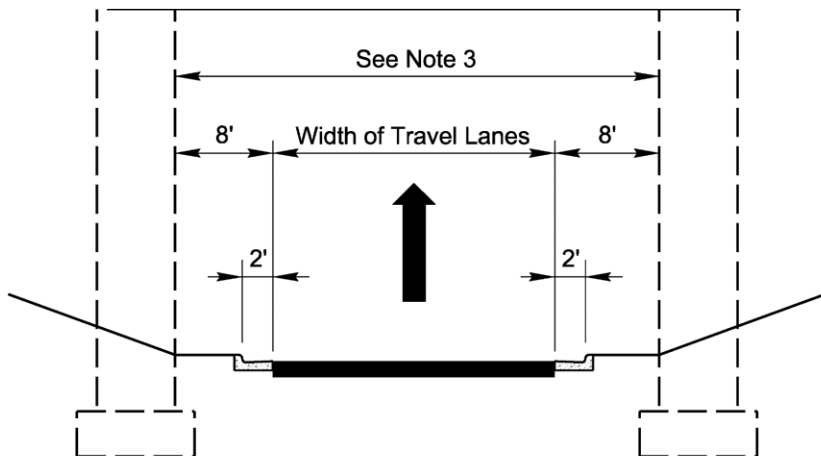

Legend

Through Travel Lanes

Notes:

1. Use 10' with directional interchange ramps. On directional interchange ramps it is acceptable to switch the widened offset to the inside of the curve when needed for horizontal sight distance.
2. Curb and gutter should be considered only to facilitate particularly difficult drainage situations. Curb and gutter is not recommended on intermediate or directional ramps, except in special cases.
3. Refer to Section 5.3.3.1 above for other considerations when determining horizontal clearance requirements.



### 5.3.3.2 Bridges over Waterways

Determine the required length of bridges crossing existing or proposed waterways (such as streams, rivers, lakes, canals, or flood relief channels) based on the Hydraulic Planning Report prepared by the Hydraulic Design Engineer in PDN Activity 2HY1. Collaborate with the Structures Lead and Hydraulic Design Engineer as needed to determine an economical and practical bridge length and identify appropriate interior bent locations during PDN Activity 2RD1.

Coordinate with the Project Manager, Structures Lead and applicable governing agencies (such as the U.S. Coast Guard or U.S. Army Corps of Engineers) on a case-by-case basis to identify bridge length, horizontal navigation clearance, and interior bent location requirements for bridges crossing navigable waterways during PDN Activity 2RD1.

### 5.3.3.3 Bridges over Railroads

Determine the required length of bridges crossing existing or proposed railroads during PDN Activity 2RD1. Collaborate with the Structures Lead and Project Manager as needed to determine an economical and practical bridge length and identify appropriate interior bent locations during PDN Activity 2RD1.

In general, provide 25 feet of horizontal clearance from centerline of track to face of bent (to avoid the need for crash walls); in most cases this will meet the roadbed standards for most railroads and will provide room for a ditch in front of the bent. For bridges over railroads owned by North Carolina Railroad (NCR), CSX, or Norfolk Southern Railroad, refer to the railroad owner's standards for additional guidance. For bridges over railroads owned by CSX (and as general good practice for bridges over any railroads) avoid locating mechanically stabilized earth (MSE) walls or other movement-activated retaining walls within the railroad right of way. Adjust these requirements to reflect individual site conditions as requested by the railroad. The Project Manager, Roadway Design Lead, and Structures Lead should coordinate with the affected railroads at the beginning of PDN Activity 2RD1 to confirm the requirements. Present the confirmed requirements in the DRPS.

### 5.3.3.4 Bridge End Bent Slopes

Coordinate with the Project Manager, Structures Lead, and Design Geotechnical Engineer during PDN Activity 2RD1 to determine the end bent slopes.

In some cases, vertical abutment walls are provided at bridge end bents to reduce span lengths and the total length of the bridge. Such cases typically involve the use of mechanically stabilized earth (MSE) walls or other retaining wall types. Coordinate with the Project Manager, Structures Lead, and Design Geotechnical Engineer during PDN Activity 2RD1 when vertical walls are considered at end bents. Consider structural issues, geotechnical issues, safety issues (such as sight distances), and future widening issues.

Generally, bridges are provided with spill-through slopes at end bents. When spill-through slopes are provided at end bents, required end bent slopes (generally either 1.5:1 or 2:1 (horizontal : vertical), measured normal to the end bent) are defined in Section 11-1 of the [NCDOT Structures Management Unit Manual](#), however in some cases site-specific conditions may require the use of nonstandard slopes.

For bridges over roadways and railroads (except where project specific requirements dictate otherwise), the Structures Lead will generally detail 4-inch-thick end bent concrete slope protection.

For bridges over roadways when the end bent fill slope is 2:1 (normal to the end bent), the Structures Lead typically details end bent concrete slope protection to the limits of the shadow line of the bridge per the provisions of Section 12-5 of the [NCDOT Structures Management Unit Manual](#). For bridges over roadways when the end bent fill slope is 1.5:1 (normal to the end bent), the Structures Lead typically details end bent concrete slope protection until the slopes are 1.75:1 or flatter.

For bridges carrying roadways on fills, use a conical (wrap around) transition from the slope under the bridge to the side slopes, where the side slopes are 2:1 or flatter. In this case end bent concrete slope protection is provided until the midpoint of the transition from the end bent fill slope (normal to the end bent) to the approach embankment side slopes; the slope at this midpoint should be 1.75:1 or flatter. Section 12-5 of the [NCDOT Structures Management Unit Manual](#) includes figures showing the end bent concrete slope protection limits for various situations.

For bridges over water, the Structures Lead will generally detail rock rip-rap slope protection at end bents in accordance with the Bridge Survey and Hydraulic Design Report (prepared by the Hydraulic Design Engineer during PDN Activity 2HY1) and the provisions of Section 12-4 of the [NCDOT Structures Management Unit Manual](#). Coordinate with the Structures Engineer, Design Geotechnical Engineer, and Hydraulic Design Engineer during PDN Activity 2RD1 to determine the required slope protection for bridges over water.

For bridges with large skew angles, there may be no slope transition in two opposing quadrants of the crossing. In this case, the 1.5:1 end bent slope will simply intersect the flatter end bent fill slope. Slope paving transitions will vary from bridge to bridge depending upon skew angle, type of grading around the bridge, pier placement, and the type of structure (single or dual). Coordinate with the Structures Engineer during PDN Activity 2RD1 to determine slope protection details at each bridge site. This coordination facilitates development of the bridge Preliminary General Drawings to enable the correct detailing in the roadway plans for paved shoulder tapers, placement of concrete barrier or guardrail, and roadway shoulder and ditch transitions on the bridge approach.

Typically, end bent concrete slope protection (pay item 4" SLOPE PROTECTION) and rock riprap at end bents (pay item RIP RAP CLASS II (1'-6" THICK) or similar) are Structures pay items and are not included in the roadway estimate. For nontypical situations (such as concrete slope protection or rock riprap at locations extending beyond the typical bridge end bent locations), coordinate with the Structures Lead to determine pay items and details for the final plans.

### 5.3.4 Vertical Clearances for Bridges

Design vertical geometry to provide adequate vertical clearance for structures crossing roadways. Meet minimum vertical clearance requirements above the full width of pavement including ~~usable~~ shoulder and minimum vertical clearance requirements above future lanes and future loops. Present vertical clearance requirements (including needed accommodations for future lanes) in the DRPS.

Identify the bridge control point as part of the vertical geometry design process. The bridge control point is the horizontal location of the point at which the minimum vertical clearance occurs. Identify the bridge control point by considering the relationship between the vertical profiles and typical sections (cross slopes and superelevations) of the roadways on and below the bridge. In many cases, the bridge control point can be clearly identified based on the interaction of profiles and cross slopes, but in other cases the bridge control point may change through the course of the development of the vertical geometry design. Examine crown points,

shoulder break points, and other changes in cross-sectional geometry as possible bridge control point locations. Examine these points on both the left and right sides of the alignments on and below the bridge. Once identified, use the bridge control point to help set vertical profiles such that minimum vertical clearance requirements are met. After designing the vertical profiles and cross-sectional geometry, confirm that minimum vertical clearance requirements are met at all possible locations of the bridge control point to check that the actual point of minimum vertical clearance has been correctly identified.

### 5.3.4.1 Required Vertical Clearances

Minimum vertical clearance requirements for highway bridges over various roadways and railroads are presented in Table 5-3. The minimum required clearance values include an allowance for 6 inches of future resurfacing. The desirable clearance values include an additional 6 inches to provide the flexibility to accommodate minor changes to final superstructure depths without redesign of the roadway geometry.

**Table 5-3 Vertical Clearances for Highway Bridges**

Element Crossed	Minimum Required Clearance	Desirable Clearance	Notes
Interstate Highways, Freeways, and Arterials	16'-6"	17'-0"	Structures over roadways with flexible (asphalt) pavements
Interstate Highways, Freeways, and Arterials	17'-0"	17'-6"	Structures over roadways with Portland cement concrete pavement
Interstate Highways, Freeways, and Arterials	17'-0"	17'-6"	Structures over roadways with pavement type not yet determined in the design process, with ADTT > 5,000
Local and Collector Roads and Streets	15'-0"	15'-6"	
Freight / Passenger / Mixed-Use Rail Route	23'-0"	23'-6"	Typical clearance requirements are shown; coordinate with affected railroad at the beginning of PDN Activity 2RD1 to confirm.
Southeast Corridor Passenger Rail Route	24'-3"	24'-9"	Affected Railroad Lines are the CSX Transportation S Line from the Virginia State Line to Raleigh Union Station in Raleigh, the North Carolina Railroad/Norfolk Southern NC Line from Raleigh Union Station to Greensboro, the North Carolina Railroad/Norfolk Southern Main Line from Greensboro to Charlotte, and the Norfolk Southern Main Line from Charlotte to the South Carolina State Line; per Amtrak's Design and Construction Criteria for Overhead Bridges as directed by FRA; coordinate with affected railroad and Rail Division at the beginning of PDN Activity 2RD1 to confirm.
Pedestrian overpass and Overhead Sign structures.	17'-6"	N/A	Clearance listed is from highest point on roadway below to lowest member of the sign or structure.

Vertical clearances significantly greater than these limits require justification by economics or by reason of the vertical geometry being controlled by other design features.

To meet 23 CFR § 646.212, the vertical clearance for highway bridges over railroads shall be as indicated in the table above, or less, if approved by the affected Railroads and NCDOT Rail Division. However, the roadway designer, Project Manager, and Structures Lead should confirm the minimum required vertical clearance with the affected railroad at the beginning of PDN Activity 2RD1 and present the confirmed requirements in the DRPS. Freeboard (minimum vertical clearance from water surface elevation to bridge superstructure low chord elevation) shall be at least 2 feet for bridges carrying Interstate highways, Freeways, Arterials, or Secondary crossings over major rivers. Freeboard shall be at least 1-foot for other roads. Freeboard less than these limits can be discussed on a case-by-case basis when conditions warrant, if approved by the Hydraulic Design Engineer, the Structures Lead, and any affected stakeholder agencies (such as the FHWA, the U.S. Army Corp of Engineers, the FEMA, or other agencies).

Identify vertical navigation clearance requirements for bridges over navigable waterways based on the U.S. Coast Guard Bridge Permit or based on agreements with the affected governing agencies or organizations.

#### 5.3.4.2 Bridge Superstructure Depths

Coordinate with the Structures Lead during PDN Activity 2RD1 to determine appropriate span arrangements, span lengths, and preliminary superstructure depths. Use the longest span length within a given bridge when determining preliminary superstructure depths and consider using the next larger depth when the controlling span length is near the upper end of the design span range. Use these preliminary superstructure depths to check preliminary vertical clearances during PDN Activity 2RD1 (refer to Section 5.3.4.1 above).

The Structures Lead will confirm the preliminary superstructure depth during PDN Activity 2ST1 and will confirm the final superstructure depth during PDN Activity 3ST1. To meet vertical clearance requirements, the roadway designer may need to revise roadway profiles to accommodate revisions to the superstructure depth.

Section 4.1.5 of the [NCDOT Structures Management Unit Manual](#) requires that the deflection of the bridge superstructure under live load be considered when calculating vertical clearances. Estimate the live load deflection as the span length divided by 800 ( $L/800$ ). Include the live load deflection as part of the allowance for the superstructure depth when calculating vertical clearances.

[NCDOT Structures Management Unit Manual Figure 6-1](#) provides a list of approximate steel girder superstructure depths that can be used for very preliminary design studies for span lengths up to 160 feet. The depths in this figure include the deck, girder build-up, and girder. Preliminary steel girder superstructure depths for span lengths greater than 160 feet are estimated by the Structures Lead on a case-by-case basis. For final design coordinate with the Structures Lead during PDN Activity 2RD1 and again during PDN Activities 2ST1 and 3ST1 to determine the overall superstructure depth.

[NCDOT Structures Management Unit Figure 11-3](#) provides a list of preliminary prestressed concrete cored slab and box beam depths for spans up to 100 feet. Note that these values reflect only the depth of the structural element. For prestressed cored slab or box beam superstructures, add the thickness of the required overlay to determine the overall superstructure depth. For very preliminary design studies, a value of 6 inches can be assumed for the overlay thickness; for final design coordinate with the Structures Lead during PDN

Activity 2RD1 and again during PDN Activities 2ST1 and 3ST1 to determine the overall superstructure depth.

[NCDOT Structures Management Unit Figure 11-3](#) also provides a list of preliminary prestressed girder depths for spans up to 125 feet. Note that these values reflect only the depth of the structural element. For prestressed girder superstructures, add the thickness of the required concrete deck and girder build-up to determine the overall superstructure depth. For very preliminary design studies, a value of 12 inches can be assumed for the thickness of the concrete deck and girder build-up; for final design coordinate with the Structures Lead during PDN Activity 2RD1 and again during PDN Activities 2ST1 and 3ST1 to determine the overall superstructure depth.

### 5.3.5 Geometric Design Considerations at Bridges

Coordinate the geometric design of the roadway at bridges with the Structures Lead early during PDN Activity 2RD1. Discuss the geometric design with regard to the guidelines presented below. When possible, adjust the geometric design of the roadway to simplify the design, detailing, and construction of the bridges. When considering the use of geometry not satisfying the ideal recommendations below, consult with both the Structures Lead and the Area Construction Engineer.

#### 5.3.5.1 Horizontal Alignment

Horizontal alignments with spiral curves greatly complicate the design, detailing, and construction of bridges. Avoid locating spiral curves on bridges whenever possible; balance this preference with other considerations such as minimizing right of way impacts.

Avoid locating circular curves on bridges if possible. When impractical to completely avoid horizontal curvature on the bridge, locate the begin and end points of the curve (PC and PT point) outside of the begin and end of the bridge if possible. When the bridge end bents are skewed, check that the acute corners of the bridge remain within the limits of the circular curve if possible.

When practical, adjust alignments to reduce or eliminate skew of the alignment being carried by the bridge in relation to the roadway or other features being crossed below. The Structures Lead may choose to reduce or eliminate the skew of end bents or interior bents by lengthening the bridge or by other means.

Combinations of curvature and skew greatly complicate the design, detailing, and construction of bridges. Avoid such geometry or minimize the severity as much as possible.

#### 5.3.5.2 Vertical Alignment

In general, design the vertical profile over a bridge to provide a tangent grade or a crest vertical curve and avoid locating sag vertical curves on bridges, particularly when the bridge superstructure uses prestressed concrete girders. Prestressed concrete girders feature upward camber at midspan and require deeper than normal girder build-ups when the roadway geometry involves a sag vertical curve; this complicates design, detailing, and construction of the bridge.

Do not locate low points on bridges, as this results in unacceptable ponding on the structure. Providing deck drains does not alleviate the ponding; deck drains at low points are particularly susceptible to clogging by sediment and debris.



When designing the vertical profiles over and under a bridge, consider the need to meet vertical clearance requirements. Refer to Section 5.3.4 above for further discussion of vertical clearances and the bridge control point.

For divided highways with separate, dual bridges: Consider designing with independent vertical profiles (also known as bifurcated profiles) when warranted by the nature of the design. Example situations might include conditions where it is desirable to have different left lane and right lane profiles to better match local topography or to better tie into driveways or cross streets near the ends of the bridge. In such situations, exercise engineering judgment and locate grade points on the appropriate alignments. Coordinate with the Structures Lead during PDN Activity 2RD1 to discuss how the roadway design will affect the design and construction of the bridges.

For divided highways with single bridges: Design a single vertical profile with the grade point at centerline of alignment.

### 5.3.5.3 Cross Slopes, Superelevation, and Cross-Sectional Geometry

In general, provide a constant cross-sectional geometry across the length of the bridge when feasible. Avoid superelevation transitions on bridges, as this complicates deck screeding. Avoid transitioning from a crown section to a superelevated section on bridges if possible; such a transition cannot be accommodated by common bridge deck screeding machines, forcing the use of specialty longitudinal deck screed machines and complicated deck placement operations.

Other limits on cross slopes and superelevation are presented in Sections 6.2.2.7, 6.4.1, and 6.5.1 of the [NCDOT Structures Management Unit Manual](#). There are several limits which, if exceeded, might render the structure extremely difficult, impractical, or impossible to construct. Coordinate with the Structures Lead during PDN Activity 2RD1 to review and discuss the cross slopes, superelevation, and cross-sectional geometry at all bridges on the project.

When designing divided highways, coordinate with the Structures Lead and the Area Construction Engineer during PDN Activity 2RD1 to discuss the location of the grade point(s). Generally, design with grade points located on the roadway surface; choose between providing a single grade point on the median centerline versus providing split grade points based on conversations with the Structures Lead and the Regional Bridge Construction Engineer, the nature of the bridge (i.e., one single bridge versus separate dual bridges), and the implications on cross-sectional geometry

### 5.3.5.4 Geometric Feature Combinations to Avoid

In addition to the items listed above, the [NCDOT Structures Management Unit Manual](#) notes that combinations of two or more of the following geometric features can result in bridge deck surfaces that are difficult to finish with typical bridge deck screeding machines.

- Skew  $\leq 75^\circ$  or  $\geq 105^\circ$
- Vertical curvature
- Transitioning superelevation
- Crowned section (e.g., normal crown)

Avoid combinations of these conditions on bridges. If it appears combinations of these conditions are unavoidable, discuss the implications with the Structures Lead and the Area Construction Engineer.

Designate the skew angles on the plans as shown in the [NCDOT Structures Management Unit Manual Figure 1-5 Skew Angle Designation](#)

### 5.3.6 Guidelines for Cored Slab and Box Beam Bridge Spans

Prestressed concrete cored slabs and box beams represent a practical and economical superstructure choice for small, short length bridges in some, but not all, situations. Section 6.1.2 of the [NCDOT Structures Management Unit Manual](#) lists functional classification, highway system, bridge length, span length, horizontal and vertical geometry, cross slopes, superelevation, and other cross-sectional geometry limits, and other considerations for the use of prestressed concrete cored slabs and box beams. Consult with the Structures Lead (and the Hydraulic Design Engineer if the bridge is a stream crossing) during PDN Activity 2RD1 to determine if cored slabs or box beams are a practical choice any given bridge site.

Various limitations and guidelines related to the use of cored slabs and box beams are listed below. If these limits are exceeded, the use of cored slabs or box beams can still be considered on a case-by-case basis, subject to approval by the Project Manager, Division Engineer, Regional Bridge Construction Engineer, and Structures Management Unit.

#### 5.3.6.1 Cored Slab and Box Beam Bridge Widths

Cored slabs and box beams are 3-foot-wide elements constructed side-by-side and post-tensioned together. As a result, the available out-to-out bridge widths vary by 3-foot increments. Increase the shoulder widths as needed on the bridge so that the sum of lane, shoulder, median, sidewalk, and barrier widths equals a 3-foot- increment. Coordinate with the Structures Lead to determine the width of barrier rails (including consideration of offsets from back face of barrier to edge of bridge deck as prescribed in Section 6.2.4 and the associated figures in the [NCDOT Structures Management Unit Manual](#)).

#### 5.3.6.2 Cored Slab and Box Beam Bridge Wearing Surfaces

Sections 6.4.3 and 6.5.3 of the [NCDOT Structures Management Unit Manual](#) specify the desired wearing surface (overlay) material (asphalt or concrete) for cored slab and box beam bridges, respectively, based on highway system, anticipated traffic volumes, and specific site conditions (such as low water crossings in some parts of the state). Consult with the Structures Lead during PDN Activity 2RD1 to determine the appropriate wearing surface material and the minimum wearing surface thickness.

Cored slab and box beam superstructures are constructed in such a way that they provide a single cross slope at the top of the prestressed concrete elements. Crown sections roadway geometry is achieved by varying the thickness of the overlay across the width of the bridge. Superelevated roadway geometry is achieved by constructing the cored slab or box beam superstructure on a cross slope (with sloped end bent and interior bent caps). Superelevation transition is achieved by varying the thickness of the wearing surface across the width and length of the bridge. Avoid situations that require excessive wearing surface thickness to achieve the desired roadway geometry.

Coordinate with the Structures Lead to determine the nominal wearing surface thickness for cored slab or box beam bridges. Consider the roadway profile, cross slope, upward camber at midspan of the cored slabs or box beams, and minimum permissible overlay thickness. Determine the nomination overlay thickness at the span ends so that the minimum permissible overlay thickness is provided at midspan.

#### 5.3.6.3 Cored Slab and Box Beam Bridge Standard Designs

Coordinate with the Structures Lead during PDN Activity 2RD1 to discuss how the roadway design can accommodate the use cored slab and box beam standard design plans if possible.

The standard plans are given for skew angles between 60 degrees and 120 degrees at increments of 15 degrees. Span lengths are given at 5-foot increments in Table 5-4.

**Table 5-4 Standard Design Cored Slab and Box Beams Parameters**

Span Length in 5' Increments	Unit Depth	Type	Superstructure Depth at Gutter line (see note)
25' to 55'	21"	Cored Slab	25"
60' to 70'	24"	Cored Slab	28"
75' to 90'	33"	Box Beam	37"
95' to 100'	39"	Box Beam	43"

Note: Superstructure depth is from top of wearing surface to bottom of prestressed concrete cored slab or box beam, measured at the gutter line. These values include a 2" allowance for the wearing surface and a 2" allowance for adjustment of the wearing surface thickness to accommodate camber of the cored slab or box beam at midspan. Adjust (increase) the values as appropriate to account for cross slope effects, especially for crown sections. In crown sections, the wearing surface at centerline of alignment is typically thicker than at the gutter line, so the effective superstructure depth used to calculate vertical clearances will be larger.

Sections 6.4.1 and 6.5.1 of the NCDOT Structures Management Unit Manual list various limits on horizontal alignment, skew, vertical curve, and superelevation or normal crown geometry for cored slab and box beam bridges, respectively.

#### 5.3.6.4 Top-Down Construction of Cored Slab and Box Beam Bridge

Cored slab and box beam units can be used when top-down construction is anticipated or required. Coordinate with the Project Manager, NEPA/SEPA Lead, and Structures Lead during PDN Activity 2RD1 to discuss the use of top-down construction. Sections 6.4.2 and 6.5.2 of the [NCDOT Structures Management Unit Manual](#) lists maximum span length limits for top-down construction of cored slab and box beam superstructures, respectively.

### 5.3.7 Bridge Constructability Guidelines

During design, constructability needs to be at the forefront of the designer's mind. Listed below are a few guidelines concerning structures for the roadway designer to consider as they begin designing. As the design progresses, designers need to coordinate with other disciplines and document design decisions to ensure efficiency.

Span Layout (see [NCDOT Structure Design Manual section 6.1.2](#) for more detail):

- For bridges on Interstate or primary routes, or bridges with more than four spans, do not use box beams or cored slabs. When a typical section requires more than 17 units, do not use these superstructure types due to adverse effects created by the large bridge width.
- For small stream crossings (i.e. less than or equal to 4 spans), prestressed concrete cored slab or box beam bridges are more economical than cast-in-place deck slab superstructures.

Cored Slab and Box Beam design (see Structure Design Manual section 6.4.1/6.5.1 for more detail):

- Box beams and cored slabs are limited to skew angles between 60° and 120° and vertical grades of 4% or less. In most cases, box beams and cored slabs should be limited to tangent horizontal alignments.



- Transversely, box beams and cored slabs may be used on superelevation of 4% or less.
- Certain combinations of skew, vertical curve, and superelevation or normal crown can result in twisting of cored slab & box beam units to the bridge seat. In such situations, maintain close coordination with the structural engineer for proper guidance.

#### Onsite detour/Temporary bridge:

- A normal crown or flatter is preferred on detour bridges. Use of superelevation should be minimized.
- For temporary detour bridges the offset should permit sufficient clearance between structures allowing for the construction of the permanent bridge and accommodation for shoring and proper drainage. Bridge skew can reduce the minimum distance provided to some of the bridge substructure elements. A minimum 10-foot offset should be maintained from the outside parapet of the permanent bridge to the inside clear roadway width of the temporary bridge as shown in the Figure 5-19 below. Early coordination with the NCDOT Area Construction Engineer is recommended.

**Figure 5-19 Minimum offset between Permanent and Detour Bridges**

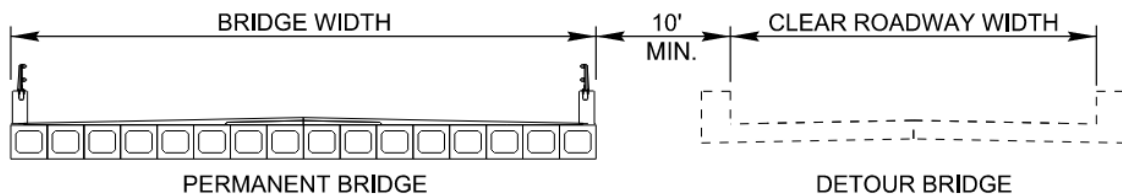

#### Staged construction:

- Occasionally, due to the proximity of existing structures or a congested work area, it may be necessary to build a structure in multiple stages. The arrangement and sequencing of each stage of construction is unique to each project. If staged construction is required, then the staging sequence, controlling lane/construction, vertical curve adjustments, skew and other design criteria should be thoroughly coordinated between Structures, the Area Construction Engineer, Work Zone Traffic Control and other appropriate disciplines as necessary.

### 5.3.8 Grading and Roadside Design Under Bridges

During the Alignment Defined Stage and PDN Activity 2RD1, the roadway designer is responsible for coordinating with the other technical discipline leads, NCDOT Units, and Division staff as appropriate to develop the Design Recommendation Plan Set. During this stage, the Structures Lead will be developing Preliminary General Drawings as part of PDN Activity 2ST2. Coordinate with the Structures Lead, Hydraulic Design Engineer, and Design Geotechnical Engineer during PDN Activity 2RD1 to determine appropriate grading and roadside design at bridges. Discuss roadside safety, drainage, slope stability, structural design, and economy.

## Drainage Under Bridges

Several factors affect drainage under bridges, including:

- Roadway and ditch grades
- Type of grading (cut or fill)
- Single or dual lane roadway
- End bent fill area treatment

Normally, there should be only a small amount of water under a bridge, except in unusual situations such as:

- Combinations of divided roadway sections and large bridge skew angles
- Cases where collected drainage from the roadway below the bridge is carried through the section under the bridge.

In some cases, special shoulder paving may be required to prevent erosion at the point where concentrated water runs from behind the concrete barrier onto the shoulder.

## Layout and Design of Bridges

The layout and design of bridges involves determining span lengths, end bent and bent locations, the types and sizes of superstructure elements, the types and sizes of substructure elements, and the types and sizes of foundations. The Structures Lead and the Design Geotechnical Engineer will address the layout and design of bridges, which is affected by various factors, including:

- Span lengths
- Total bridge length
- Vertical clearance requirements
- Skew
- Curvature
- End bent slopes

## End Bent Slopes

End bent slopes are generally determined to achieve a measure of slope stability, which is affected by:

- Local subsurface conditions
- Embankment heights
- Type of grading (cut or fill)

In some cases, retaining wall end bents may be used instead of end bent slopes.

## Grading at Bridges

Evaluate each bridge on a case-by-case basis with regard to drainage under the bridge, layout of the bridge, and end bent slopes. Once these items are determined, there are various options for grading at bridges, as well as various options for protecting bridge piers and end bent

slopes. Grading and roadside design issues at bridges typically fall into one of nine basic situations.

Four situations address protection of bridge piers, either in the median or adjacent to shoulders:

1. Median bridge piers with earth berms
2. Median bridge piers with concrete barrier or guardrail
3. Outside or shoulder bridge piers within the clear zone
4. Outside bridge piers beyond the clear zone

Treat retaining walls within the clear zone in a manner like outside or shoulder bridge piers within the clear zone.

Five situations address protection of end bent slopes without shoulder bridge piers:

1. End bent slopes with natural or false cuts
2. End bent slopes with concrete barrier or guardrail
3. End bent slopes with curb and gutter
4. End bent slopes with existing ditch (without provision for future pavement widening)
5. End bent slopes with existing ditch (with provision for future pavement widening)

Each of these situations is described below in Sections 5.3.8.1 through 5.3.8.9, respectively.

Section 5.3.8.10 discusses shoulder slope rates under bridges; this information applies to the various situations discussed in Sections 5.3.8.1 through 5.3.8.9.

Section 5.3.3.4 discusses the geometry of bridge end bent slopes; this information applies to the various situations discussed in Sections 5.3.8.1 through 5.3.8.9.

### 5.3.8.1 Median Bridge Piers with Earth Berms

Provide earth berm median pier protection when structures span over divided facilities with bridge piers located in medians of sufficient width to accommodate the required grading. Coordinate with the Structures Lead during PDN Activity 2RD1 to determine the need for, and location of, median bridge piers. Assess median width and clear zone requirements with respect to the traffic volumes and conditions of the facility under the bridge. Provide a minimum 400-foot-long transition between the normal typical section and the slope protection required at the bridge pier. Develop grading details and transitions from the typical section in accordance with [NCDOT Roadway Standard Drawings](#) Std. No. 225.08.

When the median width is not sufficient to accommodate the required grading, provide concrete barrier; refer to Section 5.3.7.2 below.

### 5.3.8.2 Median Bridge Piers with Concrete Barrier or Guardrail

Provide concrete barrier or guardrail pier protection when structures span over divided facilities with bridge piers located in medians of width insufficient to accommodate the required grading. Coordinate with the Structures Lead during PDN Activity 2RD1 to determine the need for, and location of, median bridge piers. Assess median width and clear zone requirements with respect to the traffic volumes and conditions of the facility under the bridge.

Refer to [NCDOT Roadway Standard Drawings](#) Std. No. 857.01 and 862.01 for guidance on the use of concrete barrier versus guardrail and Std. No. 854.05 for concrete barrier transition lengths and details.

Note that the presence of curb and gutter does not negate the need to provide protection when median bridge piers are located within the clear zone.

### 5.3.8.3 Outside or Shoulder Bridge Piers Within the Clear Zone

The Structures Lead will determine the need for, and location of, outside bridge piers (i.e., interior bents located between the bridge end bents and the roadway below the bridge) during PDN Activity 2RD1. The use of shoulder bridge piers (i.e., interior bents located directly adjacent to the shoulders of the roadway below the bridge) is discouraged, but in some cases may be required. Section 6.1.2 of the [NCDOT Structures Management Unit Manual](#) states that shoulder bridge piers are not permitted adjacent to the travel way.

When outside or shoulder bridge piers are required, they may be located within the clear zone. Refer to RDM Part I Chapter 4 Section 4.6 for guidance on defining the clear zone.

Measure the horizontal clearance to the face of the bridge pier, which is defined as the element of the bridge pier (the column or bent cap) closest to the travel way. In cases where very tall columns are used (where the bottom of the bent cap is located several feet above the desired minimum vertical clearance), measure the horizontal clearance to the column; otherwise measure the horizontal clearance to the face of the bent cap.

Compare the clear zone width and the horizontal clearance to the face of the bridge pier. When bridge piers are located within the clear zone, provide appropriate protection.

Refer to RDM Part I Chapter 6 for guidance on roadside barrier design. Typical protection measures include concrete barrier or guardrail; see below for further discussion of specific details related to these two options.

Note that the presence of curb and gutter does not negate the need to provide protection when median bridge piers are located within the clear zone.

#### Outside Bridge Piers with Concrete Barrier

When using concrete barrier protection, locate the end bent slope break point 1'-6" behind the face of the barrier. This is based on the 1'-5" width of the NCDOT Standard 41-inch tall Single Faced Precast Reinforced Concrete Barrier ([NCDOT Roadway Standard Drawings](#) Std. No. 857.01) with a 1-inch expansion joint between the back of barrier and the face of the turned-down toe of the 4-inch thick end bent concrete slope protection. If a wider rail is used, provide a larger dimension. The end bent slope break point is defined as the intersection of the projection of the top of the paved offset with the projection of the top of the end bent concrete slope protection.

Coordinate with the Structures Lead during PDN Activity 2ST1 to locate the bridge pier a minimum of 1'-11" behind the face of the barrier. This results in a 6-inch space between the back of the barrier and the face of the pier allowing room for the turned-down toe of the 4-inch end bent concrete slope protection with 1-inch expansion joints on both sides. The space provided will allow runoff from the end bent concrete slope protection to flow unobstructed behind the concrete barrier. Detail a full width paved shoulder from the edge of travel lane to the face of the concrete barrier. Taper the full width paved shoulder under the bridge to the typical paved shoulder width as shown in the plan view in [NCDOT Roadway Standard Drawings](#) Std. No. 610.01. Develop grading details and transitions from the typical section in accordance with [NCDOT Roadway Standard Drawings](#) Std. No. 225.09.

When the concrete barrier section extends beyond the end of slope protection paving, begin the paved shoulder taper at the end of concrete barrier.

Refer to [NCDOT Roadway Standard Drawings](#) Std. No. 610.01 for further details. See also Figure 5-20 for additional information not explicitly presented in Std. No. 610.01.

### Outside Bridge Piers with Guardrail

When using guardrail protection, locate the end bent slope break point at least 5'-6" from the face of the guardrail when standard steel beam guardrail (6'-3" post spacing with 6-foot posts) is specified. The minimum offset distance from the face of the guardrail to the end bent slope break point is 3'-6" (3'-1.5" post spacing with 6-foot posts). When the offset distance from the end bent slope break point to face of guardrail is between 3'-6" and 5'-6", specify 3'-1.5" post spacing at a point 25 feet prior to the outside bridge pier and carry the 3'-1.5" post spacing throughout the length of the outside bridge piers. If the offset distance of 3'-6" cannot be provided, use concrete barrier protection. Add a special detail or notes on the guardrail summary and plan sheets to clarify the areas where 3'-1.5" post spacing is required. Refer to [NCDOT Roadway Standard Drawings](#) Std. No. 862.01 for further details.

Figure 5-20 Shoulder Detail Under Bridge with Bridge Pier and Concrete Barrier or with End Bent Slope and Guardrail

Bridge Pier on Outside Shoulder

To be Used in Conjunction with Standard Drawing 610.01

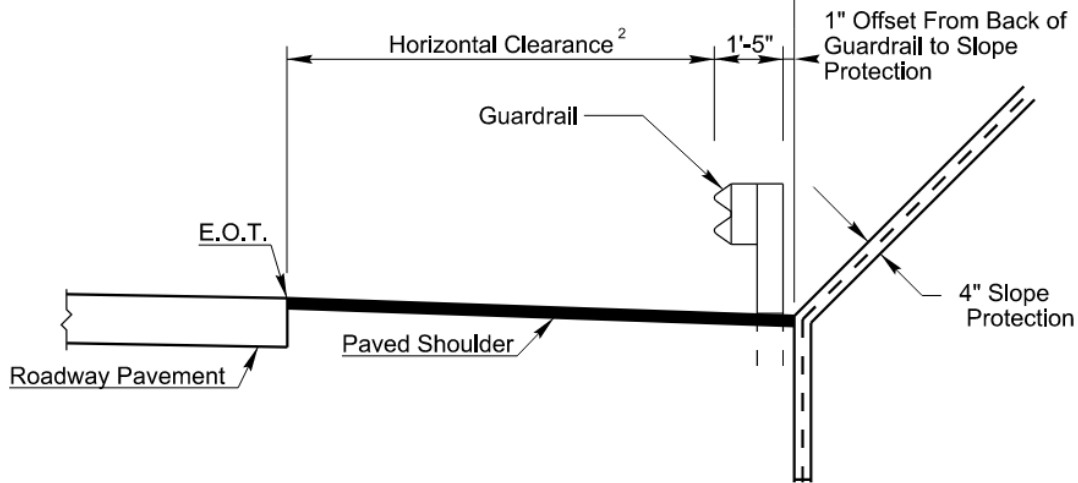
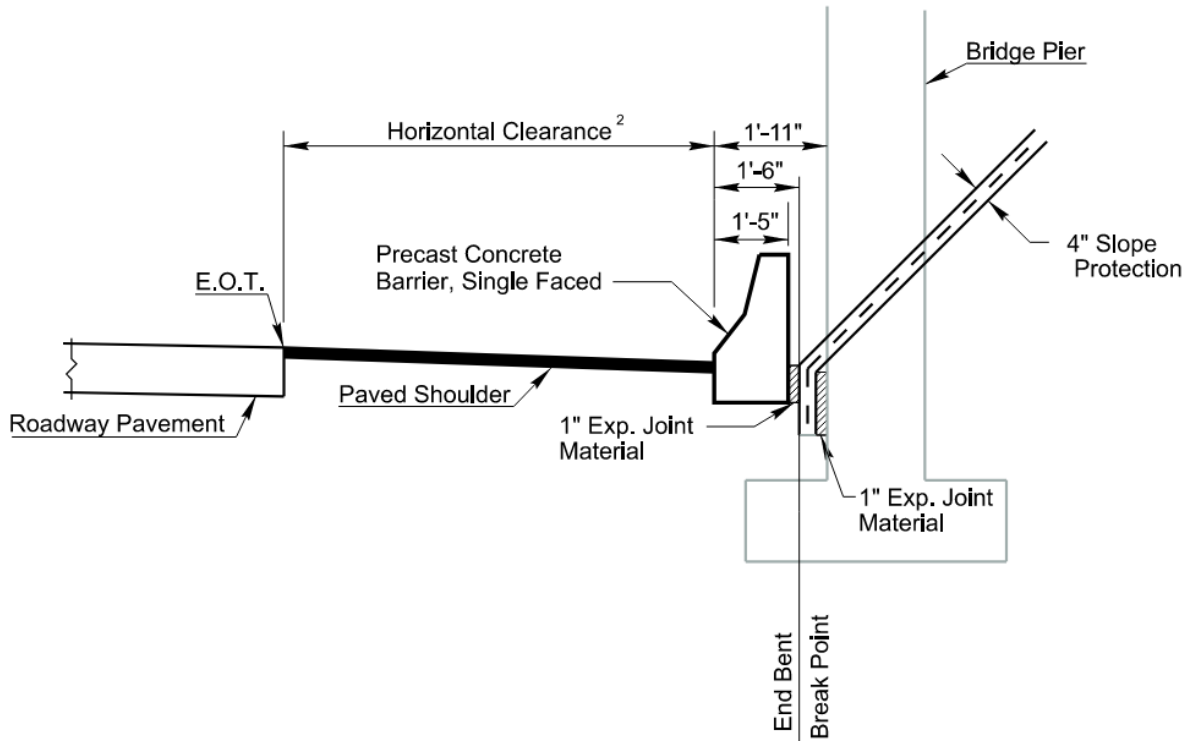

Guardrail on Outside Shoulder

To be Used in Conjunction with Standard Drawing 610.02

**Bridge Pier on Outside Shoulder**  
To be Used in Conjunction with Standard Drawing 610.01

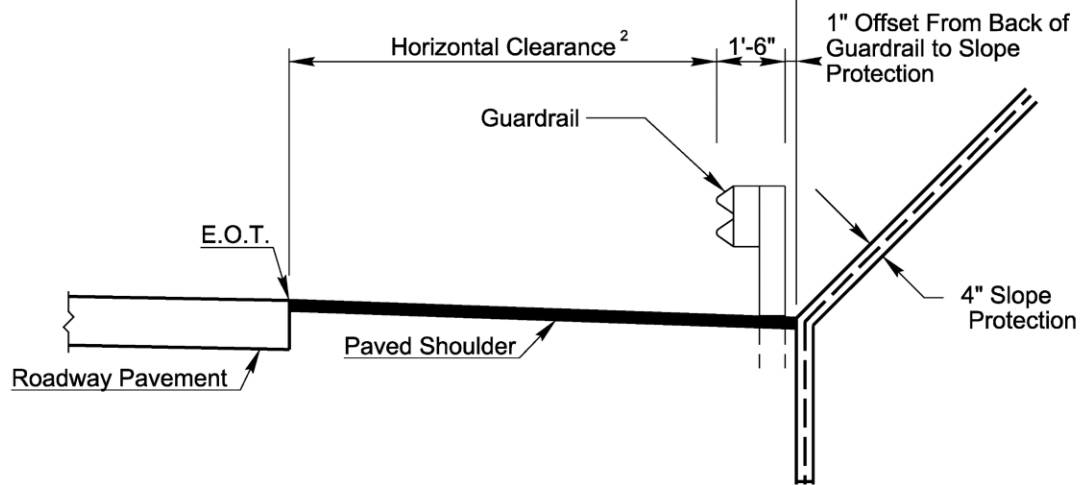
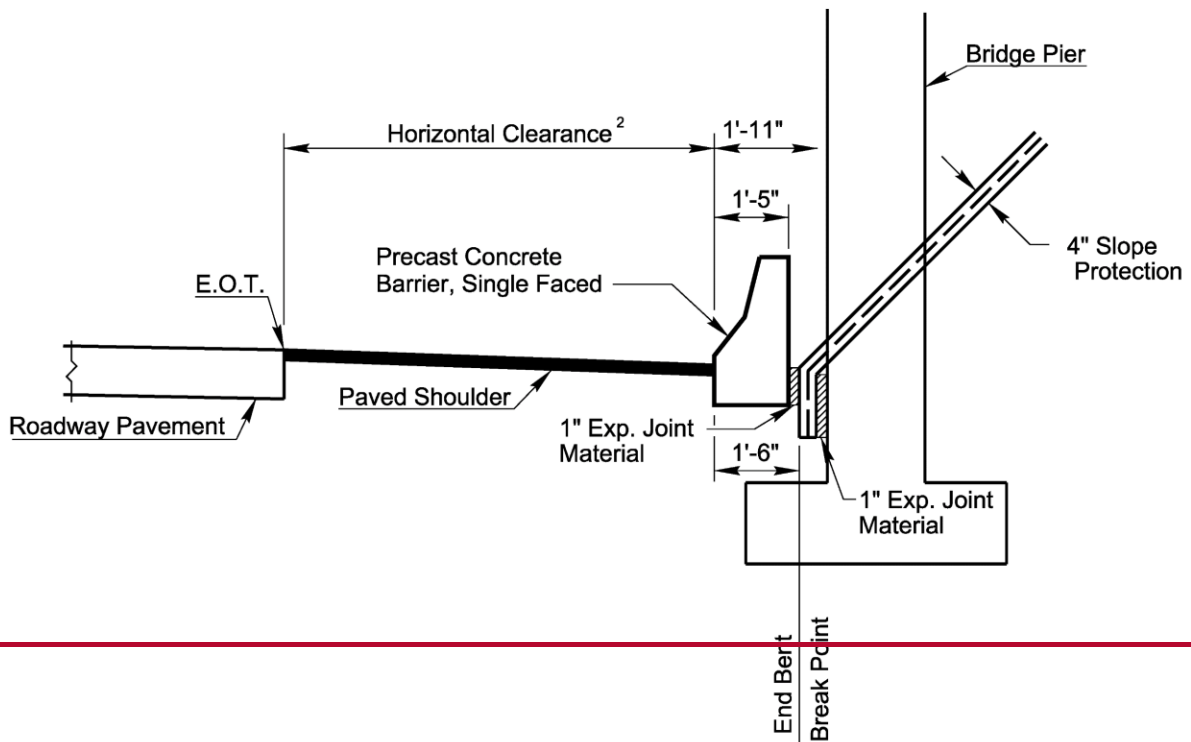

**Guardrail on Outside Shoulder**  
To be Used in Conjunction with Standard Drawing 610.02

Notes:

1. The location of the projected end bent break point for the case of a bridge pier on outside shoulder is the same as for the case of guardrail on outside shoulder.
2. Refer to Figure 5-13 thru Figure 5-18 above related to Horizontal Clearances.



#### 5.3.8.4 Outside Bridge Piers Beyond the Clear Zone

The Structures Lead will determine the need for, and location of, outside bridge piers (i.e., interior bents located between the bridge end bents and the roadway below the bridge) during PDN Activity 2RD1. In some cases, the outside bridge pier closest to the roadway may be located beyond the clear zone. These situations are typically associated with very long, multi-span bridges. The face of bridge pier is defined as the closest element of the bridge pier (whether column or bent cap). In cases where very tall columns are used (where the bottom of the bent cap is located several feet above the desired minimum vertical clearance), measure the horizontal clearance to the face of the bent cap.

In these situations, the location of the end bent slope break point is typically determined by the Structures Lead based on the required location of the end bent and the end bent fill slope. The location of the end bent in these cases may be influenced by minimum hydraulic opening criteria, the need to clear subsurface obstructions, or other governing constraints.

Develop grading details and transitions from the typical section in accordance with [NCDOT Roadway Standard Drawings](#) Std. No. 225.09.

#### 5.3.8.5 End Bent Slopes with Natural or False Cuts

Coordinate with the Structures Lead during PDN Activity 2RD1 to confirm whether a shoulder bridge pier or outside bridge pier is required. Refer to Section 5.3.8.3 or Section 5.3.8.4 if a shoulder or outside bridge pier is required.

If a shoulder or bridge pier is not required, and if the approach roadway is in a cut section, provide a natural cut slope. Refer to Section 11-1 of the [NCDOT Structures Management Unit Manual](#) for the grade of the end bent slope (1.5:1, 2:1, or other). Transition the natural cut slope to the end bent slope as appropriate if they are different; refer to [NCDOT Roadway Standard Drawings](#) Std. No. 225.07 as a guide for transition dimensions.

If a shoulder or bridge pier is not required, and if the approach roadway is in a fill section, then determine whether to provide a false cut or not. The false or natural cut provides protection for the steep end bent slopes within the clear zone at the bridge approaches.

- When the roadway under the bridge is part of an Interstate, Freeway, ~~or~~ Expressway, or Arterial on a divided highway, system, provide a false cut. (See section 5.3.8.6)
- When the roadway under the bridge is part of a Local or Collector system, provide a false cut only if suitable waste material is available.

Discuss the decision to provide a false cut with the Project Manager and Structures Lead during PDN Activity 2RD1.

Refer to [NCDOT Roadway Standard Drawings](#) Std. No. 225.07 for false cut details and Section 11-1 of the [NCDOT Structures Management Unit Manual](#) for the grade of the end bent slope (1.5:1, 2:1, or other).

If a natural or false cut is provided, the projected end bent slope break point is defined as the intersection of the projection of the top of the paved offset with the projection of the top of the end bent concrete slope protection. Coordinate with the Structures Lead to determine the location of the bridge end bents such that adequate horizontal clearance for the roadway below and the grade of the end bent slopes meets the provisions of Section 5.3.3 above. The Structures Lead may also choose to extend the span length slightly for economical or other reasons.

Round the end bent fill slope with a 6 foot vertical curve. Provide 6inch concrete slope protection, extending 4'-6" to either side of the projected end bent slope break point. This 6 inch concrete slope protection is a Roadway pay item (pay item 6" SLOPE PROTECTION). The 4inch end bent concrete slope protection (pay item 4" SLOPE PROTECTION) beyond the 4'-6" distance is a Structures pay item. Provide a full width paved shoulder between the edge of the travel lane and the beginning of the 6inch concrete slope protection. Taper the full width paved shoulder under the bridge to the typical paved shoulder width as shown in the plan view in [NCDOT Roadway Standard Drawings](#) Std. No. 610.03.

Refer to [NCDOT Roadway Standard Drawings](#) Std. Nos. 225.07 and 610.03 for additional details, including grading details and transitions from the typical section. See also Figure 5-21 for additional information not explicitly presented in Std. Nos. 225.07 and 610.03.

Refer to RDM Section 5.3.7.6 below if a natural or false cut is not provided.

Figure 5-21 Shoulder Detail Under Bridge with 6-Inch Slope Protection or Abutment Wall

6" Slope Protection on Outside Shoulder

To be Used in Conjunction with Standard Drawing 610.03

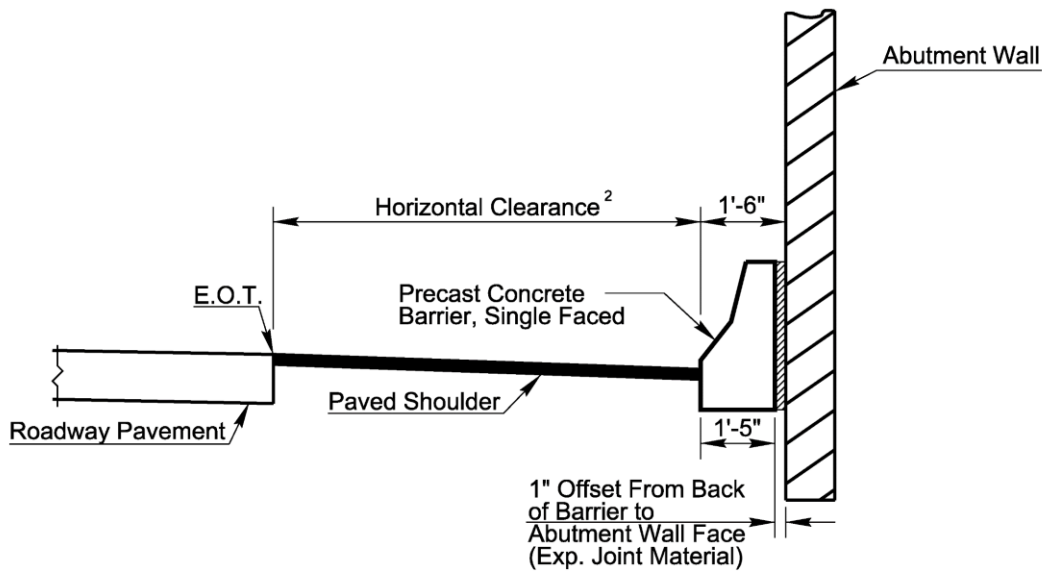
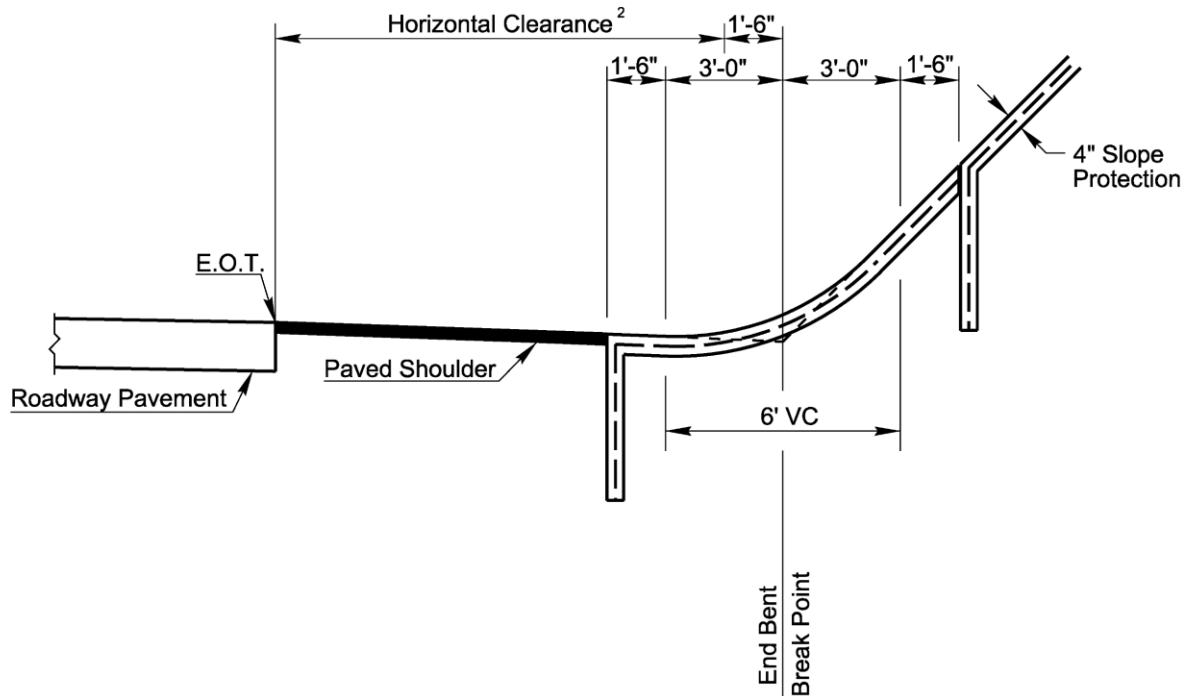

Abutment Wall on Outside Shoulder

To be Used in Conjunction with Standard Drawing 610.04

Notes:

1. The location of the projected end bent break point for the case of a 6" slope protection with a 6' vertical curve is the same as for the case of an abutment wall.
2. Refer to Figure 5-13 thru Figure 5-18 above, related to Horizontal Clearances.

### 5.3.8.6 End Bent Slopes with Concrete Barrier or Guardrail

Protect the end bent slope with concrete barrier or guardrail when:

- ~~the location of the grade separation bridge end bents is controlled by the need to provide adequate horizontal clearance for the roadway below.~~
- shoulder bridge piers or abutments are ~~not provided~~ within the clear zone.
- a natural or false cut is not provided where shoulder piers have been eliminated.

Concrete barrier is generally the preferred method of protection as it typically requires less long-term maintenance when subjected to multiple impact incidents. However, the use of guardrail can be considered on a case-by-case basis. Coordinate with Division personnel, considering anticipated crash rates, initial construction cost funding, maintenance costs, aesthetics, and the presence of features within the recovery areas outside of the clear zone.

Refer to [NCDOT Roadway Standard Drawings](#) Std. Nos. 610.01 and 610.02 for guides for paving shoulders under bridges with concrete barrier and guardrail, respectively. The end bent slope break point is in the same position whether concrete barrier or guardrail is used. Locate the end bent slope break point 1-inch behind the back of the concrete barrier or the guardrail. The end bent slope break point is defined as the intersection of the projection of the top of the paved offset with the projection of the top of the end bent concrete slope protection. The geometry of the end bent concrete slope protection and its toe wall will be the same whether concrete barrier or guardrail is used and is the same as discussed in Section 5.3.7.3 above. Extend the shoulder paving from the edge of travel lane to the slope protection paving. Taper the full width paved shoulder under the bridge to the typical paved shoulder width as shown in the plan view in [NCDOT Roadway Standard Drawings](#) Std. Nos. 610.01 or 610.02 as appropriate. Also refer to Figure 5-20 for additional information not explicitly presented in Std. Nos. 610.01 and 610.02. Refer to [NCDOT Roadway Standard Drawings](#) Std. No. 225.09 for a guide for shoulder and ditch transitions at grade separations.

### 5.3.8.7 End Bent Slopes with Curb and Gutter

When a curb and gutter section is carried beneath a bridge, locate the end bent slope break point a minimum of 1-inch behind the back of the curb, edge of the sidewalk or shared-use path to allow for a 1-inch expansion joint between it and the toe of the 4-inch concrete slope protection Figure 5-22. Coordinate with the Project Manager and appropriate agencies or other disciplines to identify the need for, and widths of, any sidewalks or shared-use paths. If outside bridge piers are used, locate the face of pier a minimum of 5 inches behind the end bent slope break point.

Figure 5-22 Berm Detail Under Bridge

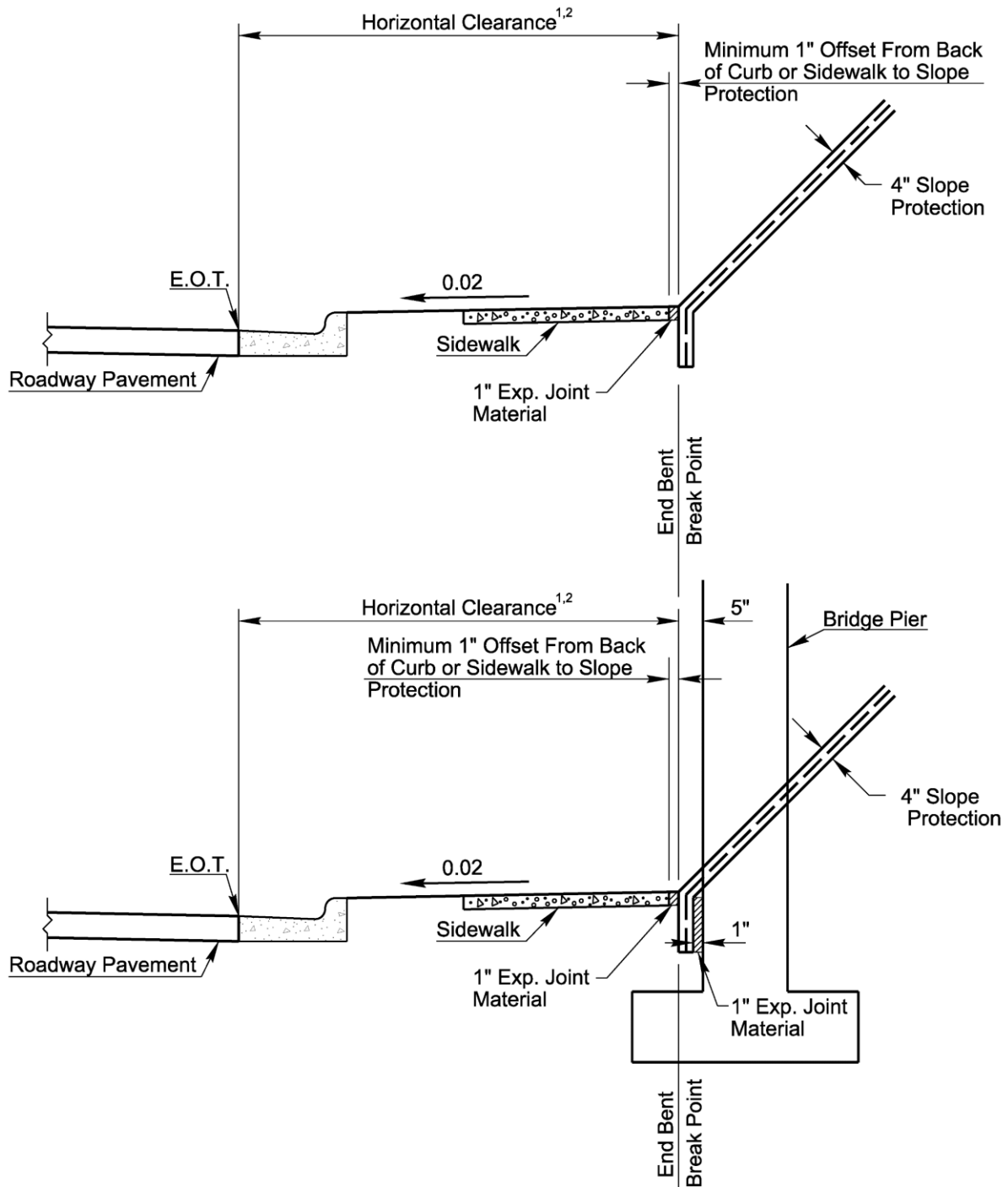

Notes:

1. Consider the width of the curb and gutter, sidewalk (if any), and other offsets (if any) on a case-by-case basis in determining the appropriate width in each location. Barrier or guardrail may be warranted depending on the clear zone requirements of the roadway.
2. Refer to Figure 5-13 thru Figure 5-18 above related to Horizontal Clearances.

### 5.3.8.8 End Bent Slopes with Existing Ditch (without Provision for Future Pavement Widening)

Follow these guidelines when a proposed bridge will be built over an existing road with no proposed changes in the pavement, shoulder, or ditch of the road beneath the bridge, and no provisions to accommodate future widening of the road under the bridge. Locate the end bent slope break point to satisfy the applicable provisions of RDM Section 5.3.3.3 above for the given facility being crossed by the bridge. The end bent slope break point is defined as the intersection of end bent fill slope with the projection of the shoulder slope from the edge of existing pavement.

Coordinate with the Structures Lead during PDN Activity 2RD1 to determine if outside bridge piers will be required. If an outside pier is needed, locate the face of the bridge pier a minimum of 5'-0" behind the end bent slope break point. If the face of the pier in this location is at least 2'-0" behind the existing ditch, the ditch should drain satisfactorily. If the face of the pier in this location is less than 2'-0" behind the existing ditch such that the pier would interfere with flow of water in the ditch, consider the following options:

1. Slightly grade the shoulder and ditch section to allow drainage to flow past the pier.
2. Eliminate the existing ditch, grade to the shoulder section and install concrete barrier or guardrail and a drainage system for the bridge end bent area.
3. Discuss locating the pier further from the ditch with the Structures Lead.

### 5.3.8.9 End Bent Slopes with Existing Ditch (with Provision for Future Pavement Widening)

Follow these guidelines when a proposed bridge will be built over an existing road with minor pavement widening and/or shoulder and ditch grading proposed initially, and with provisions for additional pavement widening in the future.

Determine bridge widths and clearances based on the traffic volumes, design speed, and bridge recommendations developed during the Project Initiation Phase under PDN Activity 1RD1. Coordinate with the Project Manager, Division Engineer, and Roadway Design Unit before implementing any provisions for future widening beyond those noted in the Record of Decision prepared under PDN Activity 2EP1.

Locate the end bent slope break point to satisfy the applicable provisions of RDM Section 5.3.3.3 above for the given facility being crossed by the bridge. The end bent slope break point is defined as the intersection of end bent fill slope with the projection of the future shoulder slope from the edge of existing pavement.

Coordinate with the Structures Lead during PDN Activity 2RD1 to determine if outside bridge piers will be required. If an outside pier is needed, locate the face of the bridge pier a minimum of 5'-0" behind the end bent slope break point. If the face of the pier in this location is at least 2'-0" behind the existing ditch, the ditch should drain satisfactorily. If the face of the pier in this location is less than 2'-0" behind the existing ditch such that the pier would interfere with flow of water in the ditch, consider the following options:

1. Slightly grade the shoulder and ditch section to allow drainage to flow past the pier.
2. Eliminate the existing ditch, grade to the shoulder section and install concrete barrier or guardrail and a drainage system for the bridge end bent area.
3. Discuss locating the pier further from the ditch with the Structures Lead.

### 5.3.8.10 Shoulder Slopes Under Bridges

See Figure 5-23 for guidance on shoulder slope rates and rollovers ~~when the roadway under a bridge is superelevated~~. The figure shows shoulder slope treatment for both the high-side and low-side for superelevation rates of .00 to .10.

~~Apply the left side of Figure 5-24 in the following cases:~~

- ~~• No paved shoulder.~~
- ~~• 4-foot paved shoulder.~~
- ~~• 10-foot paved shoulder.~~

~~Apply the right side of Figure 5-24 when providing a 2-foot full depth paved shoulder.~~

Utilize NCDOT Roadway Standard Drawings Std. Nos. 560.01 and 560.02. for the shoulder superelevation rollover rates up to 100' from the underpass approach. Coordinate with Structures to confirm the slope to be proposed under the structure according to Figure 5-23. If these are not the same, provide a uniform transition for the shoulder on all approaches over the 100' noted.

The superelevation rollover rates for shoulders are different under bridges. As the roadway superelevation goes below .02, the shoulder superelevation stays at -.04. This is held until -.05 roadway superelevation, in which the shoulder superelevation matches that of the roadway. Provide a 100-foot-long transition in shoulder slope approaching and leaving the bridge area as needed.

Figure 5-23 Standard Method of Shoulder Construction Under Bridges

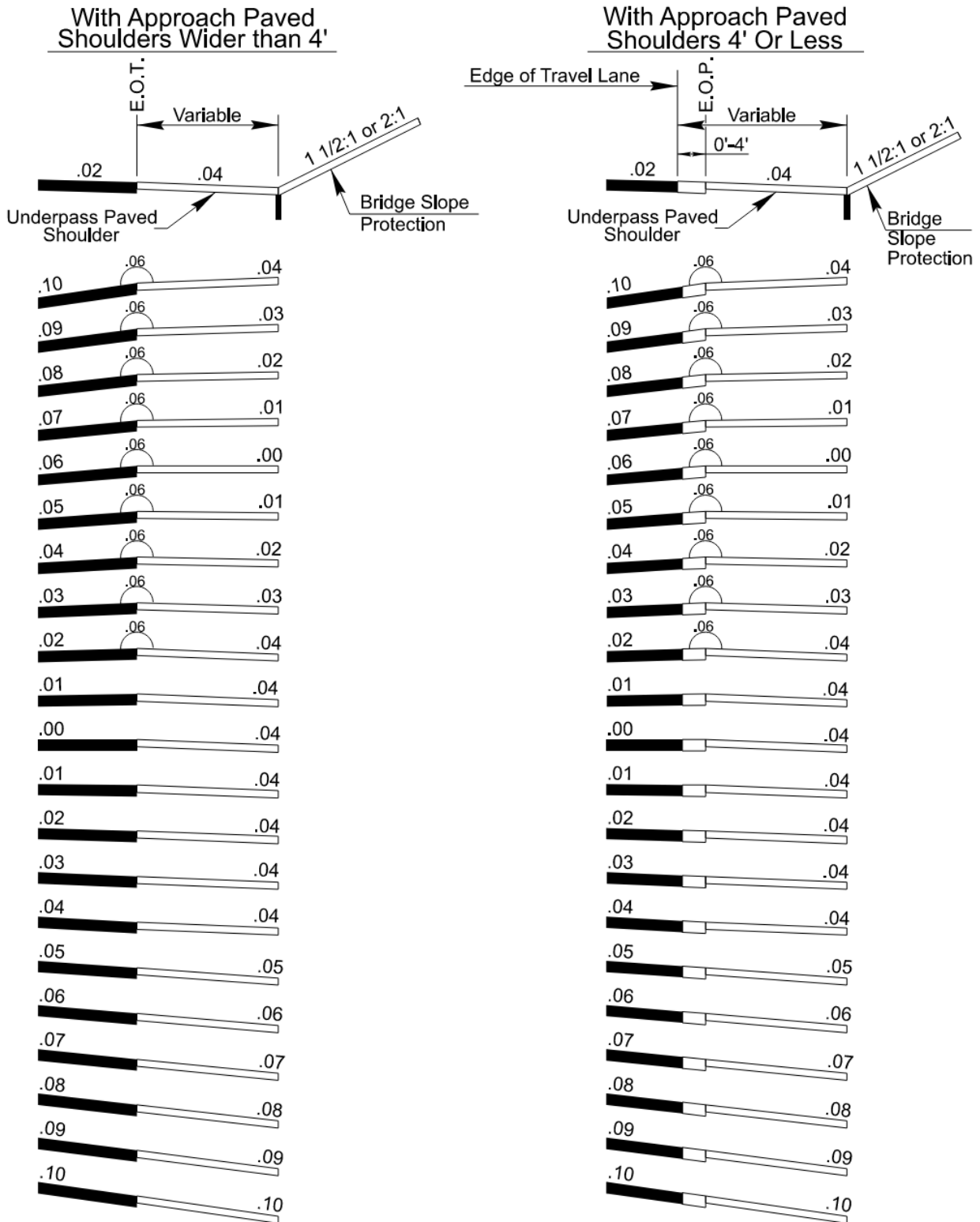

Notes:

1. Roll-over algebraic difference in rate of cross slope not to exceed 0.06 as shown.
2. Transition from above slope under bridge to roadway typical section within 100' from edge of bridge slope protection.



~~This shoulder treatment under bridges agrees with *NCDOT Roadway Standard Drawings* Std. Nos. 560.01 and 560.02 with the following exception: Do not provide the 6-inch thick slope protection with 6-foot vertical curve (per *NCDOT Roadway Standard Drawings* Std. No. 610.03) on the high side of superelevation at the bridge end bent fill. Instead, maintain a constant slope in the shoulder up to the end bent slope break point. The Structures Lead should extend the bridge end bent concrete slope protection and provide the turned down toe at the end bent slope break point. Provide a 100-foot-long transition in shoulder slope approaching and leaving the bridge area in cases where the typical roadway shoulder has the vertical curve on the high side of superelevation.~~

## 5.3.9 Bridges Approaches

### 5.3.9.1 Bridge Approach Slabs

Provide concrete approach slabs at the ends of all bridges. Sections 8.2.2 and 8.2.3 of the [NCDOT Structures Management Unit Manual](#) present bridge approach slab length and width requirements, respectively. Bridge approach slab lengths are determined based on functional classification and anticipated ADT of the facility; in some cases, longer approach slabs may be used on a case-by-case basis if suggested by local site conditions and Division preference. Bridge approach slab widths are affected by the gutter-to-gutter width on the bridge, the presence or absence of sidewalks, the type of barrier rail and end treatments used on the bridge, and curb widths as appropriate.

The *NCDOT Structures Management Unit Manual* also provides guidance regarding the geometry of the ends of approach slabs. The type of approach roadway pavement (flexible or rigid pavement) and Division preference typically determine whether the ends of approach slabs will be parallel to the bridge end bent fill faces or normal to the roadway alignment.

Coordinate with the Structures Lead and Division staff during PDN Activity 2RD1 and Activity 2ST1 to determine bridge approach slab lengths, widths, and geometry.

If the width of approach slab differs from the width of the approach roadway traffic lanes and paved shoulders, provide paved shoulder tapers using a 25:1 taper geometry (Figure 5-24).

Figure 5-24 Paved Shoulder Taper at Bridges

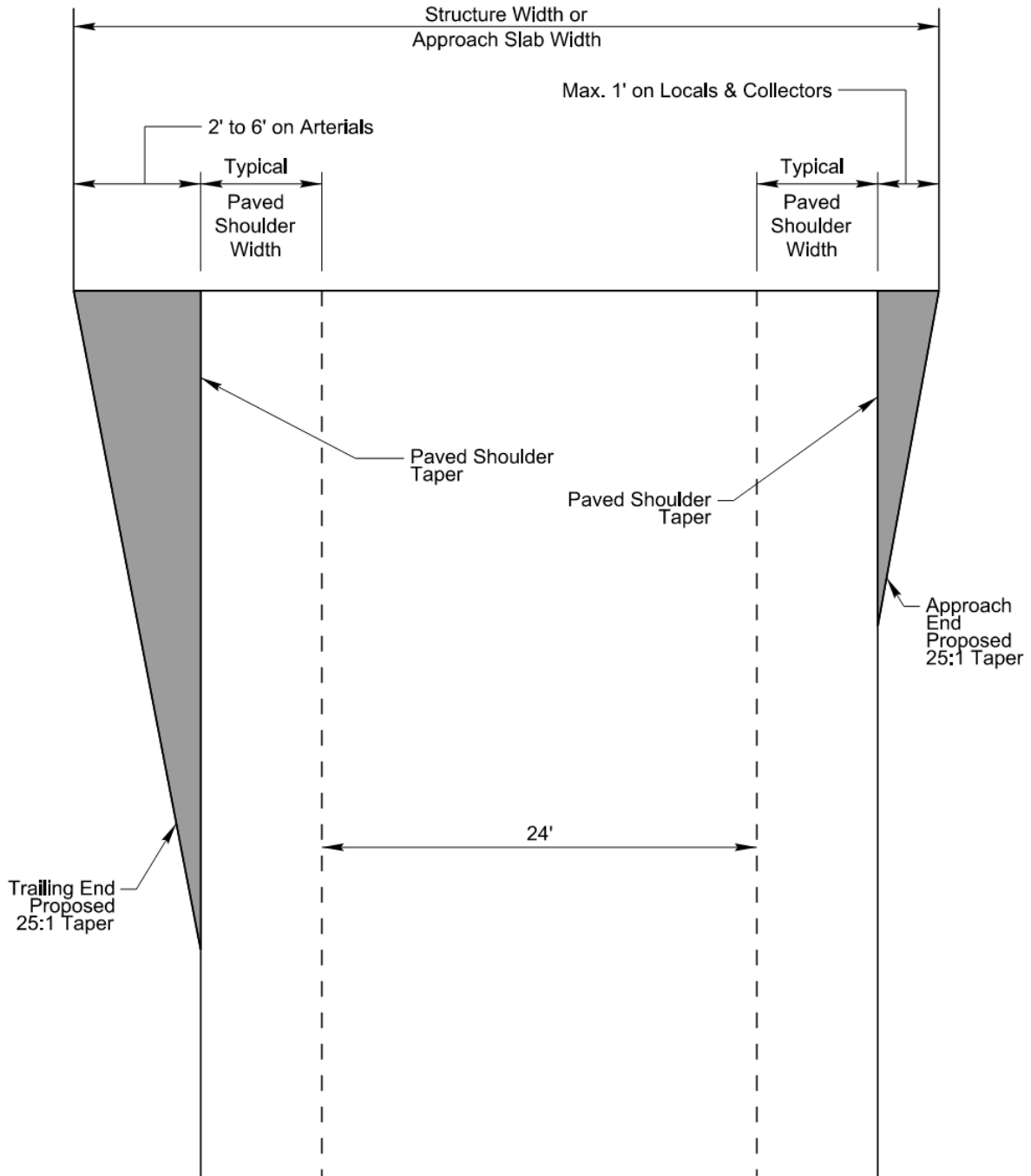

### 5.3.9.2 Bridge Approach Fills

Provide bridge approach fills at all bridges. Coordinate with the Structures Lead and Design Geotechnical Engineer during PDN Activity 2RD1 to determine which standard approach fill detail to use at each bridge, or if a special approach fill detail is needed. [NCDOT Roadway Standard Drawings](#) Std. Nos. 423.01, 423.02, 423.03 and 423.04 show standard bridge approach fill details. See Table 5-5 for typical usage of the standard bridge approach fill details.

**Table 5-5 Typical Usage of Standard Bridge Approach Fill Details**

Roadway Standard Drawing No.	Bridge Approach Fill Type	Typical Usage
423.01	Type 1 –Approach Fill	Bridges with end spans composed of steel or prestressed concrete girders and conventional end bents
423.02	Type 1A–Approach Fill	Bridges with integral abutments
423.03	Type 2–Approach Fill	Bridges with mechanically stabilized earth (MSE) walls at conventional end bents. See Note.
423.04	Type 2A –Approach Fill	Bridges with mechanically stabilized earth (MSE) walls at Integral abutments. See Note.

Note: MSE wall fill details provided by the Design Geotechnical Engineer or Structures Lead, or both.

### 5.3.9.3 Bridge Barrier Rail End Treatments

Provide bridge barrier rail end treatments in accordance with guidance in RDM Part I Chapter 6 Section 6.3. Coordinate with the Structures Lead during PDN Activity 2RD1 to determine appropriate bridge barrier rail end treatments at both ends of bridges on the project.

In general, two types of guardrail end units are available for the construction of new bridges.

1. Use Type III guardrail end unit to anchor guardrail to bridges with metal bar railing or other barrier rail types with a vertical face allowing the Type III attachment.
2. Use Type B-77 guardrail end unit to anchor guardrail to bridges with F-shape barrier rail. The end unit has a rub rail which prevents vehicles from snagging the barrier.

Refer to [NCDOT Roadway Standard Drawings](#) Std. No. 862.03 for details of both the Type III and Type B-77 guardrail end units. Show required guardrail attachment points in the DRPS.

### 5.3.9.4 Unpaved Approach Roadways

On low volume, unpaved roads, provide an approved asphalt surfacing for a distance of 100 feet from each end of newly constructed bridges. Design the paved travel lane to be 20 feet wide and transition to match the deck width of the bridge over a distance of 10 feet from the end bent fill face. Refer to Section 5.2.3 above for guardrail requirements.

## 5.3.10 Attachments to Bridges

### 5.3.10.1 Lighting

Structures Management Unit policy generally discourages the mounting of lighting on bridges. In general, lighting should be supported using separate, ground-mounted structures.

Occasionally, under bridge lighting is required under very wide structures. Small luminaires can be attached to bridge interior bents if coordinated early in the design process. Occasionally, bridge deck lighting may be required for projects with high pedestrian traffic and/or aesthetic requirements. Coordinate with the Project Manager, Roadway Lighting Design Engineers, and Structures Lead during PDN Activity 2RD1 to discuss the need for, design of, and location of, such lights and their supports. Develop details on a case-by-case basis.

Do not mount high mast lighting on bridges.

### 5.3.10.2 Fencing

Occasionally, project requirements may dictate the need to provide fencing on bridges; common situations include pedestrian bridges or highway bridges with sidewalks over railroads or highways, particularly when high volumes of pedestrian traffic are anticipated. Coordinate with the Project Manager and Structures Lead during PDN Activity 2RD1 to discuss the need for, design of, and limits of fencing on bridges. The Structures Lead can develop fencing details on a case-by-case basis. The roadway designer shall coordinate with the Structure Lead to facilitate the tie of any roadway fencing to the structure fence.

### 5.3.11 Barrier Rails and Sidewalks

Coordinate with the Structures Lead during PDN Activity 2RD1 to determine what type of barrier railings will be used on each bridge. Consider functional classification, design speeds, the presence of sidewalks, bikeways, or shared-use paths, and any project-specific criteria, commitments, or requirements. Section 6.2.4 (and associated figures) of the [NCDOT Structures Management Unit Manual](#) presents standard bridge barrier railings and associated guidance. Coordinate the use of non-standard bridge barrier railings with the Structures Management Unit. Refer to Section 5.4 for further discussion of bikeways and share-use paths on bridges.

## 5.4 Structures in Multimodal Facilities

The [NCDOT Complete Streets Policy](#) directs the Department to consider and incorporate several modes of transportation when building new projects or making improvements to existing infrastructure. Evaluate the incorporation of pedestrian, bicycle, and public transportation facilities in all transportation projects.

Coordinate with the Project Manager, Integrated Mobility Division, and NEPA/SEPA Lead during PDN Activity 1TM1 to determine what features to incorporate into the design of the project. Coordinate with the Project Manager and Structures Lead during PDN Activities 2RD1, 1ST1, 2ST1, and 2ST2 to communicate requirements that affect the design and detailing of bridges and structures. Examples of pertinent coordination items include providing horizontal clearance under bridges to accommodate proposed or future sidewalks, bikeways, or shared-use paths, and providing separate pedestrian bridges or pedestrian culverts.

Refer to RDM Part I Chapter 2 Section 2.6 for additional guidance related to incorporating multimodal facilities.

Coordinate with the Project Manager, NEPA/SEPA Lead, and Structures Lead during PDN Activity 2RD1 to determine whether to provide sidewalks on bridges. Consider providing sidewalks on new bridges with curb and gutter approach roadways on facilities without control of access. In some instances, only one side of a bridge may warrant a sidewalk. Do not provide sidewalks on bridges in controlled access facilities. When deciding whether to provide sidewalks on bridges, consider commitments made in NEPA/SEPA documents. Section 6.2.5 (and associated figures) of the [NCDOT Structures Management Unit Manual](#) provides standard

details for typical sidewalks and barrier rails on bridges. The typical detail for a sidewalk on a bridge is 5'-6" wide, comprised of a 5'-0" sidewalk and a 6-inch-wide curb section. Coordinate with the Structure Lead when a sidewalk or shared-use path wider than 5'-0" is required. Consider cross slopes when developing interface geometry. Slope the top of sidewalk to drain toward the curb regardless of the cross slope of the travel way and shoulders. Provide barrier rail as recommended in section 4.14.1 Sidewalks and Berms. If necessary, the Structures Lead can develop custom details for unique project-specific situations.

Generally, provide sidewalk, bikeway, or shared-use paths on or under bridges with the same width as provided in the approaches. Provide a barrier rail between vehicle lanes or shoulders and sidewalks, bikeways, or shared-use paths when appropriate.

Consider the needs of pedestrians and bicyclists when designing guardrail on bridge approaches. Attach guardrail to the face of the bridge barrier, behind the sidewalk, bikeway, or shared-use path. Transition the alignment of the guardrail as far away from the vehicle zone as conditions permit. For roads with shoulder approaches the minimum offset from the edge of the vehicle zone to the face of the guardrail is 4'-0".

When designing sidewalks, bikeways, or shared-use paths under bridges or in pedestrian culverts, consider the following:

- Overall length
- The need for internal lighting
- Pathway grade
- Sight distances
- Approaching pathway alignment
- Drainage
- Ease of maintenance
- Open designs which allow daylight and lighting from the outside

Coordinate with the Project Manager, Structures Lead, Integrated Mobility Division, and NEPA/SEPA Lead during PDN Activity 1TM1 to discuss required clear pathway widths (and heights) for dedicated pedestrian or shared-use bridges, culverts, or tunnels. Consider the need to accommodate service vehicles as appropriate.

## 5.5 Retaining Walls

### 5.5.1 Types of Retaining Walls

Most retaining walls are either fill walls or cut walls. Fill walls are generally constructed from the bottom up by placing fill material behind the wall. Cut walls are generally constructed from the top down by removing cut material from in front of the wall.

#### 5.5.1.1 Fill Walls

The most common types of fill walls are (1) gravity retaining walls, (2) mechanically stabilized earth (MSE) retaining walls, and (3) cantilever concrete retaining walls.

Using one of these wall types in a cut wall application typically involves extensive overexcavation and significant temporary construction impacts. Avoid using these wall types in cut wall applications.

1. **Gravity Retaining Walls** – Gravity retaining walls are typically short walls (exposed heights of 10 feet or less) that develop stability from their own weight or mass. The most common types of gravity walls are cast-in-place gravity retaining walls, segmental gravity retaining walls and precast gravity retaining walls.
  - a. Cast-in-place gravity retaining walls are constructed of cast-in-place unreinforced concrete and in accordance with [NCDOT Roadway Standard Drawings](#) Std. No. 453.01 and [Section 453](#) of the NCDOT Standard Specifications for Roads and Structures.
  - b. Segmental gravity retaining walls are constructed of segmental retaining wall units and in accordance with [NCDOT Roadway Standard Drawings](#) Std. Nos. 454.01 or 454.02 and [Section 454](#) of the NCDOT Standard Specifications for Roads and Structures.
  - c. Precast gravity retaining walls are constructed of precast retaining wall units in accordance with [Section 455](#) of the NCDOT Standard Specifications for Roads and Structures.
2. **MSE Retaining Walls** – MSE retaining walls consist of facing elements connected to layers of soil reinforcement within the retained backfill. For permanent MSE walls, steel or geogrid reinforcements are used with facing elements consisting of precast concrete panels or segmental retaining wall units. For temporary MSE walls, steel, geogrid or geotextile reinforcements are used and facing elements consist of geotextiles and wire forms.
3. **Cantilever Concrete Retaining Walls** – Cantilever concrete retaining walls are constructed of cast-in-place reinforced concrete connected to a footing. Cantilever concrete walls partially develop their stability from the weight of the backfill over the footing. Cantilever concrete walls are often more expensive than MSE walls and as a result, are normally used only when MSE walls are not feasible. Cantilever concrete retaining walls require large footings extending behind the wall, affecting temporary construction impacts and easements.

For an all-fill wall on existing ground, the existing ground line and bottom of the exposed wall are the same. A permanent underground easement or right of way is required for the MSE reinforcement length or footing width behind the wall. Fill walls can be used in cuts but require either temporary shoring or a temporary slope to construct and may also require additional construction easements.

### 5.5.1.2 Cut Walls

Cut walls can be grouped as either cantilever retaining walls or non-cantilever retaining walls. Cantilever retaining walls are constructed using only vertical elements; they have smaller temporary and permanent easement and right of way impacts, but can only accommodate limited wall heights. Non-cantilever retaining walls use tie backs or anchors to provide additional support for the wall; they often can accommodate taller wall heights, but have more significant easement or right of way impacts.

The most common types of cantilever cut walls are sheet pile retaining walls and soldier pile retaining walls.

1. **Sheet Pile Retaining Walls** – Sheet pile retaining walls consist of interlocking sheet piles driven or vibrated into the ground. Sheet pile walls are common for temporary shoring. The Geotechnical Engineering Unit has standard details for temporary sheet

- pile walls using steel sheet pile sections. Prestressed concrete sheet pile sections have been used in limited applications for permanent retaining walls.
2. **Soldier Pile Retaining Walls** – Soldier pile retaining walls consist of steel H-piles driven or placed in drilled holes and partially filled with concrete. For permanent soldier pile walls, either precast panels are set in the flanges between adjacent piles, or a cast-in-place reinforced concrete face is connected to the front of the piles. For temporary soldier pile walls, timber lagging is typically set in the flanges between adjacent piles.

The depth of the piles below the bottom of the wall is called the embedment depth. The embedment depth for cantilever cut walls is typically about twice the wall height but is highly dependent on the subsurface conditions and the surrounding geometry (i.e., front and/or back slope). Coordinate with the Design Geotechnical Engineer to determine estimated embedment depths during PDN Activity 2RD1. Use this embedment depth when checking for conflicts with utilities that may run under retaining walls.

Cantilever cut walls can be constructed very close to the right of way since no part of the wall extends behind or in front of the wall. These walls can also be used in partial fill situations and usually do not exceed 13 feet in height when standard size H-piles are used (HP 12X53 and HP 14X79). However, the process of installing sheet piles or soldier piles often involves noise and vibration. Coordinate with the Project Manager, Design Geotechnical Engineer, NEPA/SEPA Lead, and Environmental Project Lead when buildings or other nearby features may be adversely affected by noise or vibrations.

The most common types of non-cantilever cut walls are (1) soil nail retaining walls and (2) anchored retaining walls.

1. **Soil Nail Retaining Walls** – Soil nail retaining walls can only be used in cut situations (no fill) and develop stability from passive (non-tensioned) anchors (known as soil nails) that resist applied earth pressure on the wall. Soil nails consist of steel bars grouted in drilled holes inclined at an angle below the horizontal. A soil nail wall consists of soil nails spaced at a regular pattern and connected to a shotcrete and cast-in-place reinforced concrete face with nail heads embedded in the concrete. Shotcrete facing is used for temporary support of the excavation during construction.
2. **Anchored Retaining Walls** – Anchored retaining walls, also called tieback walls, develop stability from tensioned anchors that resist applied earth pressure on the wall. Anchors consist of steel bars or strands in drilled holes inclined at an angle below the horizontal that are grouted and connected to steel piles. The piles are driven or placed in drilled holes filled with concrete below the bottom of the wall. The face is usually cast-in-place reinforced concrete connected to the piles and timber lagging is typically used for temporary support of the excavation during construction. Anchored walls can be used in partial cut and fill situations, but the anchors do not develop capacity in the unbonded length through the backfill.

For an all cut wall, the grade elevation is either at or above the existing ground line. A permanent underground easement or right of way is required for the nails and anchors behind the wall.

Figure 5-25 Figure 5 illustrates a typical retaining wall section. Key components have been labeled and definitions are provided. Typical sections of the different types of retaining walls can be found as standard cells on the [NCDOT Geotechnical Engineering Unit website](#).



Figure 5-25 Typical Retaining Wall Section

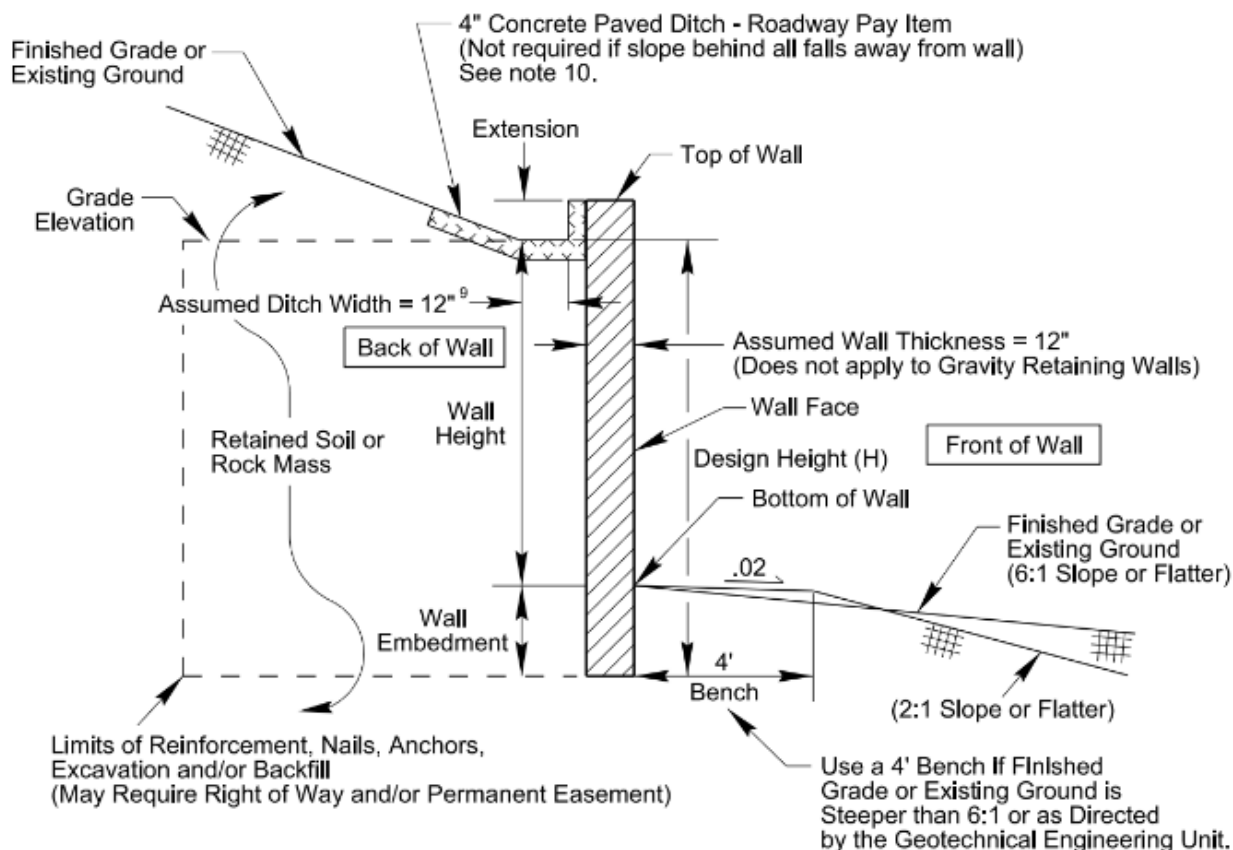

## Notes:

1. Bottom of wall - where finished grade (typically cut walls) or existing ground (typically fill walls) intersects front of wall.
2. Wall height - difference between grade elevation and bottom of wall.
3. Wall embedment - difference between bottom of wall and bottom of footing, cast-in-place face, or precast panels.
4. Extension - difference between top of wall and grade elevation.
5. Grade elevation - elevation where finished grade (typically fill walls) or existing ground (typically cut walls) intersects back of wall.
6. Top of wall - top of cast-in-place face of coping (or bottom of cap if abutment wall is part of end bent or embedded in cap).
7. Wall face - exposed face of front of wall.
8. Design height - wall height plus the wall embedment.
9. Final width of ditch to be determined by Hydraulics Unit.
10. Refer to [NCDOT Roadway Standard Drawings](#) Std. No. 850.01 for 4" Concrete Paved Ditches.

## 5.5.2 Identification, Layout, and Investigation of Retaining Walls

A retaining wall is a structure that retains or holds back a soil or rock mass. Retaining wall applications include repairing landslides, minimizing right of way requirements, shortening bridges (abutment walls), widening roads, and providing property access.

Coordinate with the Project Manager, Design Geotechnical Engineer, Structures Lead, Hydraulic Design Engineers, Utility Coordinator, and appropriate Division personnel during PDN Activity 2RD1 to collaboratively evaluate the proposed roadway design for potential locations where using retaining walls could reduce overall project costs or minimize impacts. The specific type of retaining wall employed is dependent on several factors including whether the wall is within a cut or fill section, subsurface conditions in the area around the proposed retaining wall, cost, and aesthetics.



Incorporate potential walls into typical sections, cross sections, and plan sheets and identify potential temporary and permanent impacts to environmentally sensitive areas, historical sites, landmarks, residential communities, or other features. For bridges with vertical abutment walls, the Structures Lead should develop wall envelopes under the PDN Activity 3ST1. The roadway designer and Structures Lead may need to coordinate for abutment walls (walls under bridges) that extend far from the bridge.

When considering the use of retaining walls, compare the cost of the retaining wall to the cost of other alternatives. Examples include:

- Minimizing right of way impacts – Compare the cost of retaining walls to the cost of alternatives such as roadway geometry adjustments or the use of reinforced, steepened slopes.
- Reducing bridge costs – Compare the cost of a shorter bridge with wall abutments to the cost of a longer bridge with traditional end bent slopes.

Perform cost comparisons (when appropriate) during Project Initiation, Stage 1, as part of PDN Activity 1ST1 or 1RD1. Retaining wall unit costs vary by application (cut versus fill), wall type, wall height, and subsurface conditions. Coordinate with the Project Manager, Design Geotechnical Engineer, and Structures Lead to determine the feasibility of using retaining walls, appropriate wall types, and applicable unit costs before undertaking a cost comparison study.

After confirming proposed wall locations with the Project Manager, transmit the wall locations to the Design Geotechnical Engineer for them to perform retaining wall investigations during PDN Activity 3GT2 phase.

### 5.5.3 Geometric Design and Protection of Retaining Walls

#### 5.5.3.1 Retaining Wall Alignments

Ideally, lay out retaining walls using straight alignments for ease of design and construction. Use curved walls when appropriate to maintain a constant offset from a survey line; note that the minimum permissible radius will vary depending on the type of wall. If a curved wall is specified, coordinate with the Design Geotechnical Engineer prior to preparing the preliminary wall envelope to determine whether a specific wall alignment is feasible.

Consider providing each retaining wall with its own unique alignment. Retaining wall alignments are often based on offset alignments from the roadway centerline, but it is not unusual for a retaining wall alignment to be independent of the roadway geometry. Note that for some walls, the stations may be shown on the wall envelope in descending order, since the wall envelope depicts the wall front face (the side of the wall that is exposed).

#### 5.5.3.2 Plan Presentation

Present retaining walls on the roadway plans and cross sections. Include preliminary retaining wall information in the DRPS and final retaining wall information in the final plans.

When referencing retaining walls on the roadway plans, number each wall sequentially along the -L- alignment (e.g., Retaining Wall #1, Retaining Wall #2). If only one wall is included on a project, identify the retaining wall as Retaining Wall #1. Where retaining walls are opposite each other and begin at the same station, number the wall on the left first. If a retaining wall is located along a -Y- alignment, the numbering sequence shall be based on where the -Y- alignment crosses the -L- alignment. Do not renumber the retaining walls if a wall is added after preliminary wall envelopes are submitted to the Design Geotechnical Engineer.

Show cast-in-place gravity retaining walls on the cross sections as a graphical element as shown on [NCDOT Geotechnical Standard Details](#) Std. No. 453.01. For other wall types, show retaining walls on the cross sections as a graphical element at least 1 foot thick for preliminary layout. Coordinate with the Design Geotechnical Engineer during PDN Activity 2RD1 or sooner to identify the anticipated actual wall thickness, batter, anchors, and other pertinent features, update the graphical representations on the cross sections as appropriate, and investigate for potential conflicts and impacts.

### 5.5.3.3 Wall Envelopes

A wall envelope is a profile view of the exposed wall face area. A wall envelope can be defined as a scaled plot of the grade elevations and bottom of wall elevations, the existing ground elevations (if it intersects the wall) and temporary grade elevations (if applicable) on some frequent station interval along the wall.

Provide bottom of wall elevations reflecting a 4-foot wide bench if the finished grade or existing ground in front of the wall is steeper than 6:1 or when directed by the Design Geotechnical Engineer as shown in Figure 5-26. Show the grade and bottom of wall elevations both graphically and numerically. Depict the existing ground line on the envelope, even if it differs from the grade or bottom of wall. These elevations depict whether the wall is a cut wall or a fill wall or a combination of the two.

Depict and label the grade and bottom of wall at 50-foot station intervals (e.g., Sta. 10+00, 10+50) along the offset centerline from the beginning to the end of each wall. Where the grade lines are highly variable, the Design Geotechnical Engineer may request the elevations be labeled more frequently. Include calculations of the wall face area with the wall envelope.

Develop preliminary wall envelopes during PDN Activity 2RD1 and final wall envelopes during PDN Activity 3RD1. See below for descriptions of each.

#### Preliminary Wall Envelopes

Label the following information on the preliminary wall envelope:

- Station and offset distance at the beginning of wall, end of wall, and where the wall alignment changes (if applicable)
- The grade and bottom of wall elevation at 50-foot station intervals (e.g., Sta. 10+00, 10+50)

Show where the grade elevation intersects the bottom of wall (where the grade and bottom of wall elevations are equal, i.e., where the wall height is null). This will typically occur at the begin and end of each wall. Also show station, offset, grade elevation, and bottom of wall elevation at each point where the wall alignment changes (i.e., at each point where the wall alignment bends). Consider using plus or minus station references (e.g., Sta. 10+12 +/-) to label the estimated beginning and ending of each wall. The Contractor is required to survey the existing ground elevations and submit a revised wall envelope for review and approval prior to designing and constructing each wall.

Wall envelopes are typically drawn using an exaggerated vertical scale.

When walls are not provided with their own unique wall alignment, be aware that wall envelopes may not be depicted accurately in the following situations:

- Walls that do not have a constant offset related to the centerline alignment
- Walls that are located in curves

For these cases, add the following note to the wall envelope drawing: “THE WALL ENVELOPE DOES NOT ACCURATELY DEPICT THE ACTUAL FACE OF THE WALL.” In these situations, calculate the wall faces areas by hand instead of measuring the areas in the drawing, since the wall envelope drawing presents a distorted view of the wall face.

Figure 5-26 shows an example wall envelope.

Figure 5-26 Example Retaining Wall Envelope Drawing

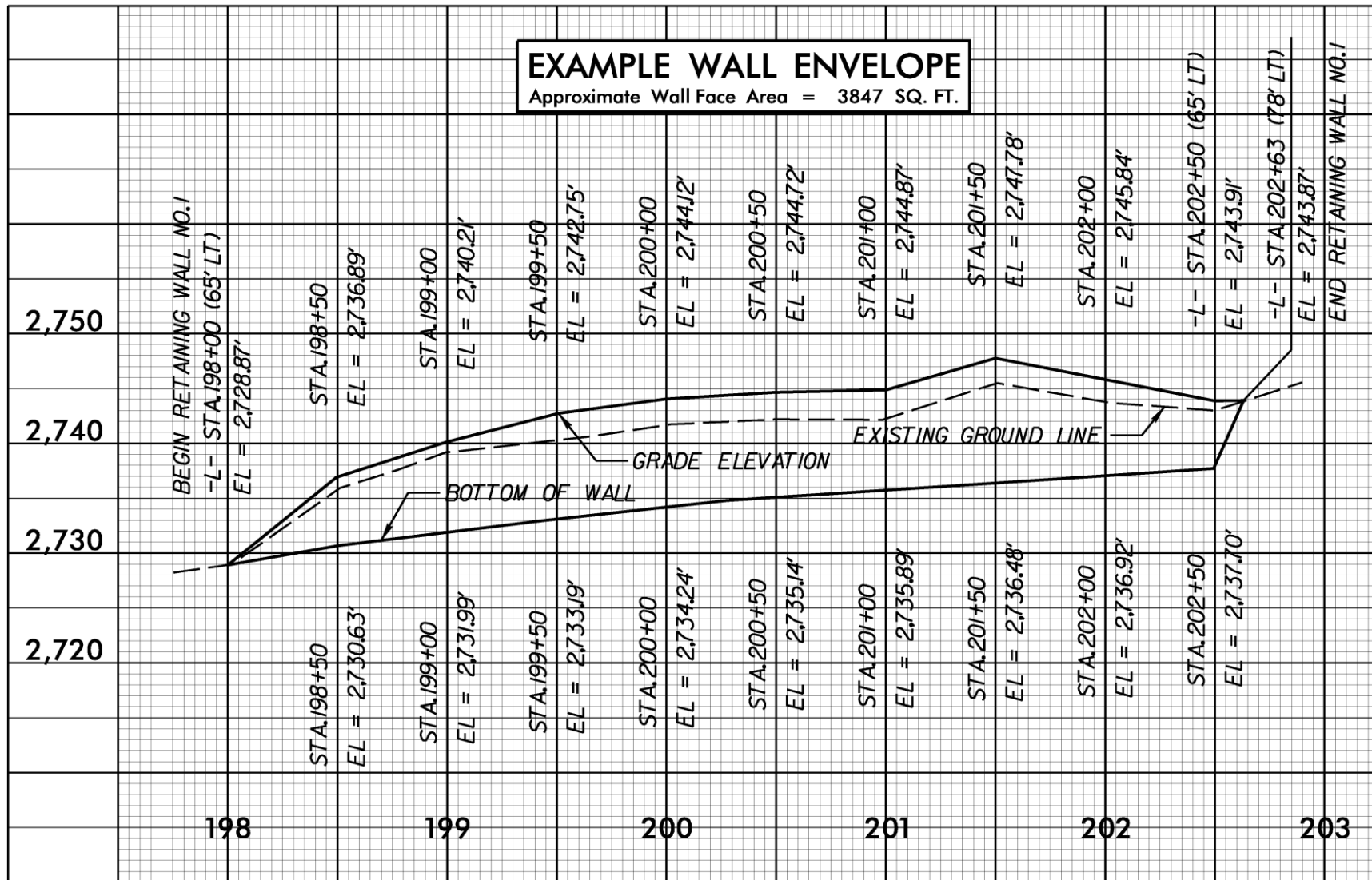

## Final Wall Envelope

Submit a final wall envelope to the Design Geotechnical Engineer during PDN Activity 3RD1, after revising the plans based on input from other discipline leads comments from the combined or final design Field Inspection. Show the same items in the final wall envelopes as were shown in the preliminary wall envelopes. The main differences between the preliminary and final wall envelopes are typically minor changes to the stations and elevations.

Note that drainage ditches in the vicinity of the wall may affect the grade elevations on the final wall envelope. Coordinate with the Project Manager, Design Geotechnical Engineer, Hydraulic Design Engineer, WZTC Project Design Engineer, Structures Lead and others as applicable to obtain input prior to preparing the final wall envelopes. Include the final wall envelopes in the retaining wall plans and not the roadway plans, except when there are no structures plans for the project and the retaining wall plans are inserted in the roadway plans as W-series sheets.

If a retaining wall is eliminated during the design of the project, include a note in the plans clarifying why the wall numbers are no longer in sequence. Include the note on the plan sheet that depicts the next wall in the series. For example, if Retaining Wall #2 was eliminated, include a note on the plan sheet that contains Retaining Wall #3 stating, "RETAINING WALL #2 HAS BEEN ELIMINATED." Do not provide such notes when the retaining wall eliminated was the only wall on the project or the wall numbering sequence was not affected.

### 5.5.3.4 Construction Limits

Construction limits to determine right of way or easements vary depending on retaining wall geometry and wall type. Request preliminary retaining wall construction limits from the Design Geotechnical Engineer during PDN Activity 2RD1. The Design Geotechnical Engineer should present final retaining wall construction limits in the roadway foundation recommendations prepared during PDN Activity 3GT2. For cut walls during preliminary design, in the absence of better information from the Design Geotechnical Engineer, right of way or permanent easement approximately 1.2 times the maximum wall height (1.2H) may be shown behind a cut wall in most situations until project specific information is provided. However, for cut walls taller than 15 feet in the coastal plain, contact the Design Geotechnical Engineer as more than 1.2H may be needed for right of way or permanent easement. The coastal plain region is located within Divisions 1-3 and portions of Divisions 4, 6 and 8. For fill walls, assume a preliminary right of way limit at least 5 feet in front of the face of retaining wall.

### 5.5.3.5 Protection of Retaining Walls

If a wall is located within the clear zone, use steel beam guardrail, single-faced reinforced concrete barrier or concrete barrier rail with a moment slab to protect traffic.

#### Steel Beam Guardrail (Top or Bottom of Wall)

Place steel beam guardrail at the bottom or the top of a retaining wall as necessary to protect the hazard. Offset steel beam guardrail 5'-6" from the face of the guardrail to the nearest wall surface when standard steel beam guardrail (6'-3" post spacing with 6-foot posts) is specified. The minimum offset distance from the face of the guardrail to the nearest wall surface is 4'-0" at the top of the wall (6'-3" post spacing with 8-foot posts) and 3'-6" at the bottom of the wall (3'-1.5" post spacing with 6-foot posts). When the offset distance from the wall surface to face of guardrail is between 3'-6" and 5'-6" at the bottom of the wall, specify 3'-1.5" post spacing at a point 25 feet prior to the wall and carry the 3'-1.5" post spacing throughout the length of the wall. If the offset distance at the bottom of the wall is less than 3'-6", specify single-faced concrete

barrier. Add a special detail or notes on the guardrail summary and plan sheets to clarify the areas where 3'-1.5" post spacing and extra depth 8-foot posts are required. Coordinate with the Design Geotechnical Engineer to investigate whether guardrail posts conflict with the retaining wall design. Figure 5-27 illustrates the offset requirements for steel beam guardrail in relation to the wall.

**Figure 5-27 Offsets for Steel Beam Guardrail at Retaining Walls**

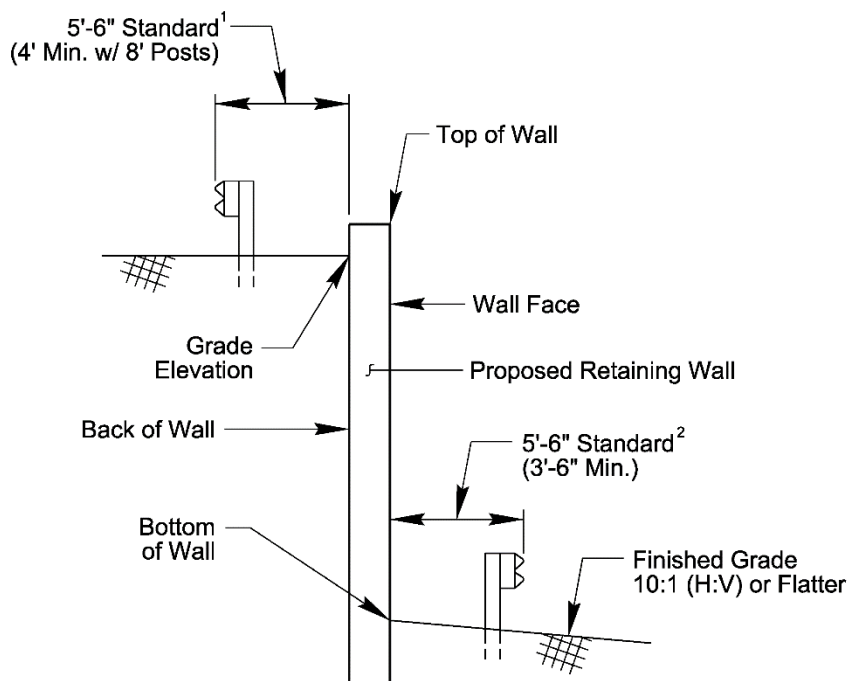

Notes:

1. Use concrete barrier rail with moment slab if offset is less than 4'.
2. Specify 3'-1.5" post spacing when the offset distance at the bottom of the wall is between 3'-6" and 5'-6".

### Concrete Barrier Rail with Moment Slab (Top of Wall Only)

If the offset distance from the face of the guardrail to the top of a retaining wall is less than 4 feet, provide a concrete barrier rail with moment slab. Locate concrete barrier rail with moment slab on top of the wall with no offset as illustrated in Figure 5-28. When concrete barrier rail with moment slab is required, coordinate with the Design Geotechnical Engineer and Structures Lead to confirm design details and identify pay items (Concrete Barrier Rail is a Structures pay item). Due to its relatively high cost, use a concrete barrier rail with moment slab only when other options, such as moving the wall far enough from the travel way to allow the use of steel beam guardrail, are not possible or are less economical.

Include details for the concrete barrier rail with moment slab with the retaining wall plans. Coordinate with the Design Geotechnical Engineer to obtain the most current standard details for concrete barrier with moment slab.

Attach guardrail to the concrete barrier rail with appropriate anchors per the most current guardrail policies. If a guardrail is attached to the concrete barrier rail, extend the barrier the entire length of the wall.

Concrete barrier rail with moment slab is not designed to accommodate pedestrian traffic adjacent to the barrier rail. If sidewalk is proposed adjacent to the concrete barrier rail,

coordinate with the Design Geotechnical Engineer and Structures Lead, who will assess the associated loading on the retaining wall and who will design a custom barrier rail with moment slab, respectively.

Figure 5-28 Concrete Barrier Rail with Moment Slab on Retaining Wall

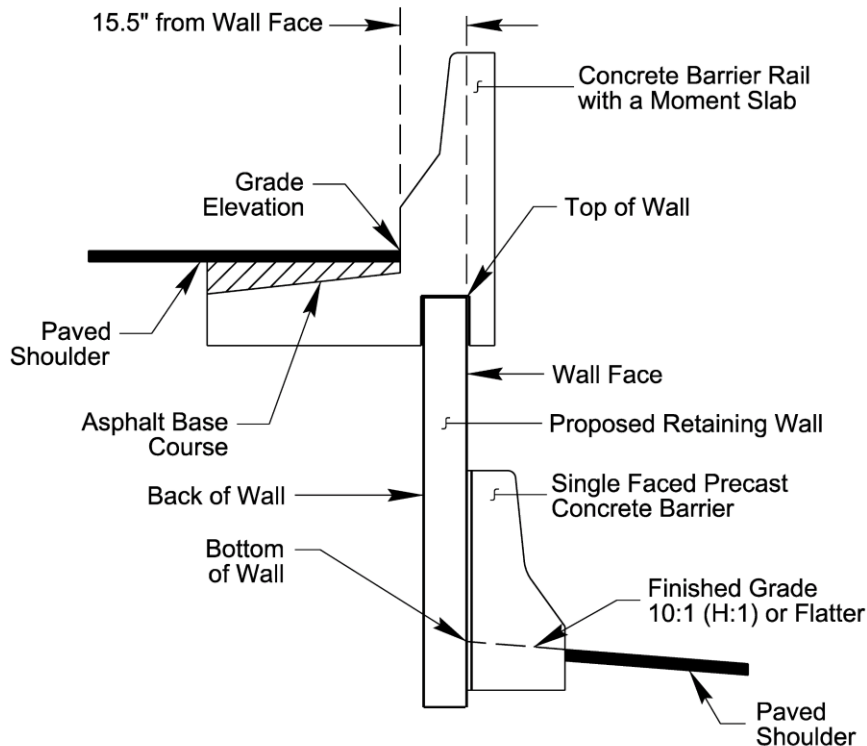

### Single-Faced Reinforced Concrete Barrier (Bottom of Wall Only)

Locate single-faced reinforced concrete barrier next to a wall face when needed at the bottom of a retaining wall. Account for a 1-inch expansion joint between the concrete barrier and the wall. If guardrail needs to be attached to the single-faced concrete barrier, extend the barrier the entire length of the wall. Attach guardrail to the concrete barrier with appropriate anchors per the most current guardrail policies. Figure 5-28 illustrates the placement of single-faced concrete barrier in relation to the bottom of wall. In some cases, the placement of single-faced concrete barrier at the bottom of wall can result in significant cost savings by reducing the wall height (the wall face can be placed closer to the edge of travel lane when concrete barrier is used instead of steel beam guardrail). If future widening is not anticipated in the vicinity of the bottom of the wall, coordinate with the Design Geotechnical Engineer to determine if the use of single-faced concrete barrier will result in cost savings.

Include a typical section inset in the roadway plans depicting the placement of the single-faced barrier or guardrail in relation to the retaining wall. Clearly label any proposed offset distances in the inset. When a concrete barrier rail with moment slab is specified, detail asphalt base course (B25.0C) to fill the area between the subgrade and the top of moment slab.



### Fence or Handrail Placement:

Provide a fence or handrail when pedestrian traffic is anticipated in the vicinity of the top of a retaining wall. Determine whether handrail or fence is appropriate, based on the height of the wall and the project conditions in the vicinity of the wall. Preferably, locate fence or handrail no closer than 1-foot from the back of wall, and design the fence or handrail posts foundations using standard details. Coordinate with the Design Geotechnical Engineer when providing fence or handrails in the vicinity of a wall to determine if the fence or handrail posts will conflict with the retaining wall design.

If it is necessary to locate a fence or handrail directly on a retaining wall, attach the fence or handrail posts to a properly designed cast-in-place concrete structural element (part of the wall or coping). Request the Structures Lead design the proposed details, or use applicable, previously designed, standard details obtained from the [State Plans and Standards Engineer](#) in the Contract Standards and Development Unit to prepare details for the attachment to the wall. Incorporate the fence or handrail details into the roadway plans as 2-Series sheets.

Show chain link fence that is attached to a retaining wall in the appropriate fence summary and identify it for payment under [Section 866](#) of the NCDOT Standard Specifications for Roads and Structures as Chain Link Fence, \_\_\_" Fabric, per linear foot. Add a label to the fence summary to reference the sheet number (for example: "SEE DETAIL SHEET 2-? FOR FENCE ATTACHMENT TO RETAINING WALL) showing appropriate fence details and sections. Use standard chain link fence symbology to denote the chain link fence on the roadway plans. Use a generic fencing pay item and provide a Special Provision to address payment for handrail that is attached to the wall. Include the handrail in the list of Special Provision items.

Consider the maintenance of vegetation when guardrail, fence, or handrails are provided at the top of the wall. Consider providing asphalt or Class A stone for erosion control between the guardrail, fence, or handrail and the retaining wall to reduce the need for maintenance in areas that are difficult to access. Provide a typical section inset or detail showing the asphalt or Class A stone.

Coordinate with the Design Geotechnical Engineer during PDN Activity 2RD1 to determine if the presence of vegetation or other erosion control details might affect the design or performance of the retaining wall.

### 5.5.4 Request for Retaining Wall Design

Initiate the request for retaining wall design during PDN Activity 2RD1. Coordinate with the Project Manager, Design Geotechnical Engineer, Hydraulic Design Engineer, and Structure Lead. Allow sufficient time for subsurface investigations and preliminary retaining wall design to occur during PDN Activity 2GT2.

Include the following information with the request for retaining wall design:

1. Plan sheet(s), profile sheet(s), and cross sections in the location of the proposed retaining wall(s)
2. Wall plan view(s) with offset centerline(s) and distances and curve data (if applicable)
3. Preliminary wall envelope(s)
4. Other factors that need to be taken into account in the design of the wall(s) (e.g., drainage, utilities, lighting, fence, guardrail, barrier)



### 5.5.5 Temporary Shoring

Temporary shoring is often required to maintain traffic. On occasion, temporary shoring may be used to protect wetlands, buildings or structures. Temporary shoring is often used during the removal of existing bridges and structures. Refer to the [NCDOT Temporary Shoring Memorandum](#) dated January 17, 2007, for additional information regarding various design responsibilities.

If temporary shoring is required for maintenance of traffic, show the shoring on the roadway plans, without stationing, in the plan view. Refer to the traffic control plans for the temporary shoring. If temporary shoring is required at more than one location, show the quantity for each location on the traffic control plans.

On occasion, the roadway designer will request temporary shoring. In this situation, show the shoring location, including station and offset information, on the roadway plans. Show the typical sections and accompanying notes on the roadway plans. When shoring is required at more than one location, show the quantity for each location on the roadway plans.

If temporary shoring is required, the Design Geotechnical Engineer may provide standard shoring details for insertion into the final plans. The number of detail sheets will be dependent on the notes referenced in the Geotechnical Engineering Unit's standard notes document, [NCDOT Temporary Shoring – Shoring Notes](#). Place the standard shoring details in the roadway plans as 2G Series sheets.

## 5.6 Sound Barrier Walls

The Traffic Noise and Air Quality Group Leader and the Environmental Analysis Project Lead will develop a Final Design Noise Report during PDN Activity 3EN1, providing required locations and limits of proposed sound barrier walls. Additionally, the Final Design Noise Report will include wall envelopes based on proposed grades and the locations of cut/fill sections to establish minimum noise wall heights along the length of any proposed noise wall. Prior to design implementation, review wall locations, limits, and envelopes for constructability, feasibility, utility conflicts, environmental impacts, and roadway design criteria allowances with the Project Manager, Structures Lead, Design Geotechnical Engineer, Hydraulic Design Engineer, NEPA/SEPA Lead, Utility Coordination Project Lead, and any other affected discipline leads.

Address wall placement, stations and offsets, and roadside protection at sound barrier walls in the roadway plans. The Structures Lead should prepare sound barrier wall plans using the Sound Barrier Wall (SBW) standard drawings when possible, and custom designs when necessary. The Design Geotechnical Engineer should provide sound barrier wall foundation recommendations.

Typically, include SBW plans in the structure plans, except when walls are the only structures on the project; in that event, include the SBW plans in the roadway plans.

Show SBWs on the roadway plans and cross sections. When referencing SBWs on the roadway plans, number each wall sequentially along the -L- alignment (for example, "Sound Barrier Wall #1") with begin and end stations identifying the limits of the proposed SBW. Where SBWs are opposite each other and begin at the same station, number the wall on the left first. If a sound barrier wall is located along a -Y- alignment, the numbering sequence shall be based on where the -Y- alignment crosses the -L- alignment. Coordinate the SBW numbers with the Structures Lead.

Develop the alignment for SBWs shall be using the information provided in the Final Design Noise Report and the Structures Management Unit's SBW standard drawings.

When developing wall alignments, be mindful of the following:

- Consider sight distances; check that appropriate sight distances are provided when are not sufficient; consider changing the SBW alignment or eliminating the SBW.
- Avoid locating SBWs on bridges. If an SBW must be located on a bridge, limit the height to 10 feet or less. Coordinate with the Structures Lead whenever the location of SBWs on bridges is being considered.
- Structures Management Unit's standard SBW details allow for 10foot and 15foot pile spacing. Consider the footprint of SBWs on curved alignments based on chording between the piles when evaluating right of way and clear zone impacts.
- Assume consistent pile spacings the entire length of the wall. Structures Management Unit's standard SBW details allow for 10foot and 15foot pile spacing. When necessary, only use non-standard pile spacings at the ends of the wall or turning points. Do not use pile spacings less than 5 feet.
- Standard precast concrete panels are used with 10-foot or 15-foot pile spacings. Twentyfoot pile spacings are allowed but standard precast panels are not included with the standard drawings. In such cases, the Structures Lead must perform a custom design.
- Structures Management Unit's standard SBW details show the wall height as the accumulative height of stacked panels, with a minimum embedment depth of 6 inches at the bottom panel.
- Structures Management Unit's standard SBW details are only applicable for wall heights of 25 feet or less when precast concrete piles are specified, and 29 feet or less when steel piles are specified.
- Walls exceeding 29 feet in height require custom designs. SBWs with heights significantly greater than 29 feet become increasingly impractical from structural design perspective.
- When using precast concrete piles, limit kinks in the wall alignment to angles less than or equal to 45 degrees.
- Changes of more than 1foot (drop or rise) in the top of wall elevation between panel sections are not permitted, except in the first panel section at either end of the wall. Top of wall elevation changes resulting in a jagged appearance are not allowed.

## 5.7 Drainage at Bridges

### 5.7.1 Bridge Deck Drainage

Coordinate with the Structures Lead, Hydraulic Design Engineer, and potentially the NEPA/SEPA Lead (for bridges over waterways) during PDN Activities 2RD1, 2ST1, 2ST2, and 2HY1 to address bridge deck drainage. Discuss various options to address excessive spread on bridge decks when predicted by hydraulic design calculations; choose options that best address project needs overall.

During storm events, drainage runoff can accumulate at the gutter lines on bridges. The width of this runoff accumulation is called the hydraulic spread. Generally, the hydraulic spread should be limited to the shoulders and not extend into the travel lanes. When the width of the hydraulic spread exceeds the width of the shoulders, the design should be adjusted. There are several options for addressing excessive hydraulic spread on bridges:

1. Adjust the vertical profile to improve drainage and reduce hydraulic spread in bridge gutters.
2. Increase bridge deck width to provide wider shoulders to accommodate hydraulic spread.
3. Provide bridge approach drainage to intercept some of the runoff before it reaches the bridge.
4. Provide open drains in the bridge deck at the barrier rail gutter lines.
5. Provide bridge deck drains that feed into a closed drainage system.

Adjusting the vertical profile can reduce the amount of runoff before it reaches the bridge or can accelerate the longitudinal flow of runoff on the bridge (thus reducing the hydraulic spread). In many cases, minor adjustments to the vertical profile can reduce or eliminate excessive hydraulic spread on bridges without adding cost to the project.

Increasing bridge deck width to provide wider shoulders on the bridge allows for wider hydraulic spread without impacts to traffic. In some cases, this can reduce or eliminate the need for open deck drains or a closed drainage system. Although the increase in bridge deck width will increase the initial construction cost of the project, the cost increase may be warranted by the reduction in long term maintenance costs associated with a closed drainage system or by the avoidance of open deck drains discharging over environmentally sensitive areas.

Bridge approach drainage (i.e., inlets just beyond the bridge approach slabs, at the higher end of the bridge) can intercept much of the runoff prior to it reaching the bridge. This reduces hydraulic spread on the bridge, potentially enough to minimize or avoid the need for bridge deck drains. Drainage inlets are a common feature on highway projects and adding inlets at bridges generally does not significantly increase initial construction costs or long-term maintenance costs. Refer to Section 5.7.2 below for additional discussion of bridge approach drainage.

## 5.7.2 Bridge Approach Drainage

As mentioned in Section 5.7.1 above, providing bridge approach drainage is an effective way of reducing hydraulic spread on bridge decks and thus reducing or eliminating the need to provide bridge deck drains. Coordinate with the Structures Lead and Hydraulic Design Engineer during PDN Activities 2RD1, 2ST1, 2ST2, and 2HY1 to address bridge approach drainage.

Choose bridge approach drainage treatments based on the approach roadway conditions. The most common situations include:

### 5.7.2.1 Roadways with Shoulders

Metal funnel drains, grated drop inlets, or concrete bridge approach drop inlets are the most common treatments. Coordinate with the Hydraulic Design Engineer, who will determine which treatment is appropriate.

### 5.7.2.2 Curb and Gutter Roadways

Coordinate with the Hydraulic Design Engineer, who will determine the specific design and details.

# Chapter 6 Roadside Barriers

## 6.1 General Considerations

Roadside barriers are generally used to prevent vehicles that leave the roadway from colliding with rigid objects or embankment slopes located along the side of the roadway or with vehicles coming in the opposite direction.

Common types of barriers are steel beam guardrail, cable guiderail, and concrete barrier. This section of the RDM discusses specific types of barriers and their use.

Use roadside safety hardware compliant with the AASHTO *Manual for Assessing Safety Hardware (MASH)* 2016 and NCDOT Memo September 11, 2017 [Roadside Safety Hardware – MASH-16 Implementation Plan](#).

The use of roadside barriers along the side of the roadway warrants careful consideration. Where applicable, adjust the design elements of the project to reduce or remove the need for roadside barriers.

The preferred method of addressing roadside hazards is as follows:

1. Remove the hazard
2. Remove embankment hazard (flatten slopes)
3. Shift hazard away from traffic
4. Reduce the impact severity by using breakaway posts
5. Protect the hazard
6. Delineate the hazard so motorists are aware of the hazard

Refer to Table 6-1 below and GB Chapter 4 Section 4.10 for detailed discussion of roadside barriers.

## 6.2 Longitudinal Barriers

Longitudinal barriers are roadside barriers placed parallel to the travel way to protect motorists from hazards along the side of the roadway. The most common type of longitudinal barrier in use today is the 12-foot 6-inch W-beam galvanized steel beam guardrail (noted as guardrail in the following information); however, other barrier types such as concrete or cable barrier may be more appropriate for a specific location. The following sections describe warrants and guidelines for locations where longitudinal barriers should be considered.

### 6.2.1 Barrier Warrants

Consider use of a protective barrier, or barrier warrant, when it has been determined that impacts to the protective barrier will be less severe than impact with the roadside hazard. Design barrier warrants in accordance with the RDG.

When determining barrier warrants, an important concept to understand is clear zone. From the RDG: “a clear zone is the unobstructed, traversable area provided beyond the edge of the through traveled way for the recovery of errant vehicles. The zone includes shoulders, bike lanes, and auxiliary lanes, except those auxiliary lanes that function like through lanes”.

Refer to RDM Part I Chapter 4 Section 4.6 for more information on the importance of clear zones.

Establish the location and grade of the project so as to eliminate as much barrier as possible using these warrants.

After location data is received, plans plotted, grades set, and initial templates determined, adhere to the following procedures:

1. Determine potential barrier locations or warrants using the clear zone guide and Table 6-1 below.
2. Determine if barrier can be eliminated
  - a. Can the hazard be removed, relocated, or made breakaway?
  - b. Does a cost effectiveness analysis justify flattening slopes?
  - c. Include the additional costs for right of way, drainage, borrow, erosion control, and clearing, in the initial cost of the slope-flattening alternative.
  - d. Will the design decision increase impacts on wetlands?
3. Use the clear zone guide:
  - a. Refer to RDM Part I Chapter 7 Section 7.5 for pipe end treatment guidelines for cross drainage pipe within the safety zone.
  - b. For large pipes or culverts that have openings within the clear zone, justify use through a cost effectiveness analysis by either extending the pipes or culverts beyond the safety limits, leaving the drainage as it is without barrier protection, or using barrier to protect the hazard.
  - c. Check the ditch sections for any non-traversable front or back slope within the clear zone. The ditch may remain unshielded if the back slope is smooth and free from hazards.
  - d. If justified, check to see that all obstructions within the clear zone are removed, modified for safety, or protected by barrier.
  - e. Check landscape plans to be sure that reforestation is not proposed within the safety clearing limits.
  - f. On low volume, unpaved roadways, guardrail is generally warranted only for bridge rail protection. Refer to RDM Part I Chapter 5 Section 5.2 for guidelines pertaining to Subregional Tier Bridge Projects.

**Table 6-1 Barrier Guidelines for Non-Traversable Terrain and Roadside Obstacles** <sup>a,b</sup>

Obstacle	Guidelines
Bridge piers, abutments, and railing ends	Shielding generally required.
Boulders	Judgment decision based on nature of fixed object and likelihood of impact.
Culverts, pipes, headwalls	Judgment decision based on size, shape, and location of obstacle.
Foreslopes and backslopes (smooth)	Shielding not generally required.
Foreslopes and backslopes (rough)	Judgment decision based on likelihood of impact
Ditches (parallel)	Refer to RDG Figures 3-6 and 3-7.
Ditches (transverse)	Shielding generally required if likelihood of head-on impact is high.
Embankment	Judgment decision based on fill height and slope Refer to RDG Figure 5-1(b).
Retaining walls	Judgment decision based on relative smoothness of wall and anticipated maximum angle of impact.
Sign/luminaire supports <sup>c</sup>	Shielding generally required for non-breakaway supports.
Traffic signal supports <sup>d</sup>	Isolated traffic signals within clear zone on high-speed rural facilities may warrant shielding.
Trees	Judgment decision based on site-specific circumstances.
Utility poles	Shielding may be warranted on a case-by-case basis.
Permanent bodies of water	Judgment decision based on location and depth of water and likelihood encroachment.

## Notes:

- a* Shielding non-traversable terrain or a roadside obstacle usually is warranted only when it is within the clear zone and cannot practically or economically be removed, relocated, or made breakaway, and it is determined the barrier provides a safety improvement over the unshielded condition.
- b* Marginal situations, with respect to placement or omission of a barrier, usually will be decided by crash experience, either at the site or at comparable sites.
- c* When appropriate, most sign and luminaire supports should be of a breakaway design regardless of their distance from the roadway if there is reasonable likelihood of an errant motorist hitting them. The placement and locations for breakaway supports also should consider the safety of pedestrians from potential debris resulting from impacted systems.
- d* In practice, relatively few traffic signal supports, including flashing light signals and gates used at railroad crossings, are shielded. If shielding is deemed necessary, however, crash cushions sometimes are used in lieu of a longitudinal barrier installation.

Source: RDG Chapter 5 Table 5-2

## 6.2.2 Length of Need

After it has been determined through use of the previous tables that roadside barrier is warranted, determine the total length of barrier needed. Barrier will be warranted throughout the entire length of the hazard. Provide adequate protection for errant motorists, extend barrier beyond the hazard.

The length of need will vary depending on traffic volume, design speed, and type of hazard present. Follow Figure 6-1 through Figure 6-4 when determining the length of need (or X) for protection of a fill slope or rigid obstacle.

Note: Do not leave a space of less than 300 feet between guardrail installations. Extend the guardrail through the area if less than 300 feet exists between installations.



Refer to RDG Chapter 5 Section 5.6.4 for the formulas and details on calculating the total length of barrier needed to protect a hazard.

The minimum length of guardrail between end units is 12.5 feet when the design speed is 45 mph or less and 25 feet when the design speed is greater than 45 mph. Guardrail end units and structural anchor units are not designed to connect to each other warranting a section of guardrail between them.

### 6.2.2.1 Fill Slope Warrants

Fill slope warrants are locations along a fill or embankment where the use of a barrier should be considered based on the height of the fill and the slope of the front slope as noted in the RDG Chapter 5 Figure 5-1(b). Where possible, the front slope should be flattened to avoid the need for a barrier.

Generally, if the fill height is 6 feet or greater with front slopes of 2:1 and 12 feet or greater with front slopes of 3:1, a barrier should be considered. When determining barrier warrants, use engineering judgement and document all design decisions. NCDOT has been using guardrail warrant flags to denote the potential need for barrier warrants in the cross sections.

Note that with fill slopes of 2:1 or steeper, an errant vehicle has an increased chance to rollover. At a 3:1 slope, an errant vehicle should traverse the slope without rolling over, but the slope is considered too steep for the vehicle to recover. On 4:1 or flatter slopes an errant vehicle will be able to traverse the slope and recover.

## 6.3 Guardrail Placement

### 6.3.1 Placement on Approach End of Rigid Obstacle Warrant

Refer to Figure 6-1 when determining the length of need (or X) on the approach end of a rigid obstacle warrant. A rigid obstacle can be an object such as a tree, bridge pier, culvert, headwall, or retaining wall.

Refer to RDM Part I Chapter 5 Section 5.2.3 for information on how to determine the minimum guardrail lengths for subregional tier bridge projects.

For guardrail installations at bridges, refer to the [NCDOT Roadway Standard Drawings](#) Std. No. 862.01 Sheets 1 thru 4. Place steel beam guardrail on 10:1 or flatter slopes.

Use the following variables to determine the length of need on the approach end of the rigid obstacle warrant:

- $L_C$  = Clear zone distance for the roadway. Refer to RDM Part I Chapter 4 Section 4.6.
- $L_A$  = Distance from the edge of the travel lane to the backside of the hazard.
  - Note: Use  $L_C$  as  $L_A$  value if the hazard extends beyond the clear zone.
- $L_R$  = Runout length or theoretical distance needed for a vehicle which has left the roadway to come to a complete stop. Refer to RDG Chapter 5 Section 5.6.4 Table 5-10b.
- $N_1$  = The distance from the edge of the adjacent travel lane to the face of the guardrail.
  - $N_1$  = Normal shoulder width for locals and collectors (minimum 4 feet).
  - $N_1$  = Normal shoulder width plus 2 feet for arterials, interstates and freeways.



The above values are listed on Figure 6-1 and can be used in the following formula:

$$X = \frac{L_A - N_1}{L_A / L_R}$$

Note: This formula is for use on tangent alignments. A graphic solution is more suitable for curve alignment.

- X = Length of need which will be measured from the approach end of the hazard (area of concern) to the guardrail end unit (GREU).

Figure 6-1 Detail of Guardrail Placement on Approach End of Rigid Obstacle Warrant

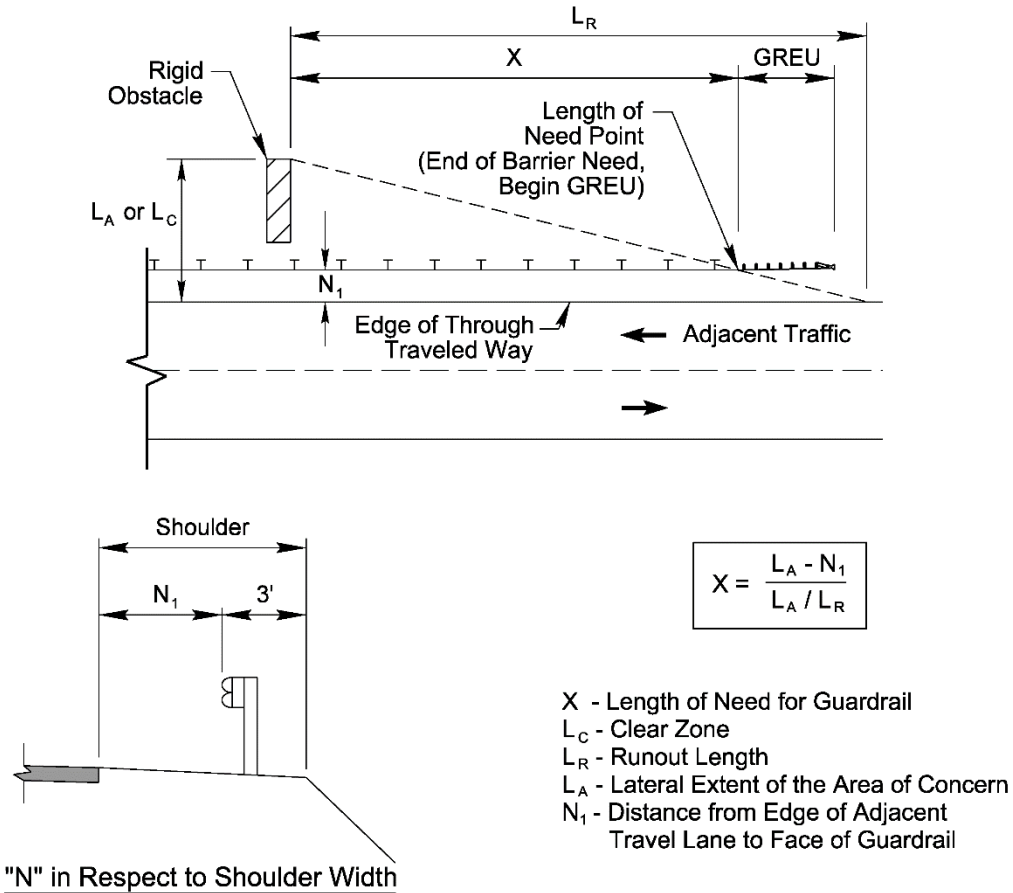

Note: For normal shoulder widths refer to RDM Part I Chapter 4 Section 4.4 Tables 4-1 and 4-2. Note that the width of the shoulder from the edge of travel lane to the face of guardrail increases in certain scenarios as defined in Chapter 4.

Source: RDG Chapter 5 Section 5.6.4 Figure 5-39

### 6.3.2 Placement on Trailing End of Rigid Obstacle

Use Figure 6-2 to determine the length of need (or X) on the trailing end of a rigid obstacle warrant. The variables used in determining the length of need are as follows:

- $L_A$  = Distance from the edge of the opposing travel lane to the area of concern. (Note diagram in Figure 6-2 )
  - As on the approach end, use  $L_A$  if  $L_C$  is less than  $L_A$ .
- $L_C$  = Clear zone distance for the roadway. Refer to RDM Part I Chapter 4 Section 4.6.1.

- $N_2$  = Distance from edge of opposing travel lane to the face of the guardrail.
- $L_R$  = Runout length. Refer to RDG Chapter 5 Section 5.6.4 Table 5-10b.

On roadways where the distance from the edge of the opposing travel lane to the face of guardrail is equal to or greater than the clear zone distance, use a CAT-1 Anchor Unit placed 25 feet beyond the end of the guardrail warrant point (refer to Figure 6-2).

Figure 6-2 Detail of Guardrail Placement on Trailing End of Rigid Obstacle Warrant

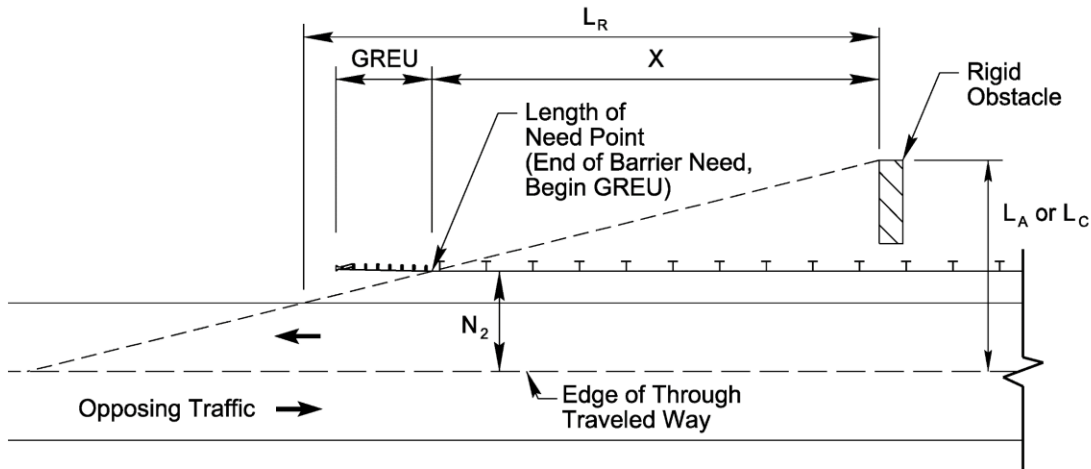

$$X = \frac{L_C - N_2}{L_C / L_R}$$

- $X$  - Length of Need for Guardrail
- $L_C$  - Clear Zone
- $L_R$  - Runout Length
- $L_A$  - Lateral Extent of the Area of Concern
- $N_2$  - Distance from Edge of Opposing Travel Lane to Face of Guardrail

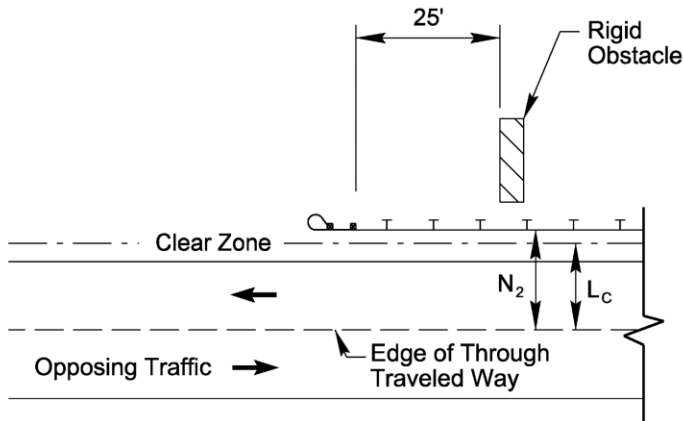

Notes:

1. When  $N_2$  is equal to or greater than  $L_C$ , a CAT-1 anchor unit can be used and be placed 25' beyond the end of the guardrail warrant point.
2. Refer to RDG Chapter 5 Section 5.6.4 Figure 5-42 for additional information.

### 6.3.3 Placement on Approach and Trailing End of Fill Slope Warrants

Use Figure 6-3 in determining the length of need (or  $X$ ) on the approach and trailing end of a fill slope warrant.

Refer also to RDG Chapter 5 Section 5.6.4 Table 5-10b; and RDM Part I Chapter 4 Sections 4.4.1 and 4.6.1. Use the formula from RDG Chapter 5 Section 5.6.4 or the formula referenced in Figure 6-3 below to determine the length of need. On roadways where the distance from the edge of the opposing travel lane to the face of guardrail is equal to or greater than the clear zone distance, use a CAT-1 Anchor Unit placed 25 feet beyond the end of the guardrail warrant point (refer to Figure 6-2 above).

Figure 6-3 Detail of Guardrail Placement on Approach and Trailing End of Fill Slope Warrant

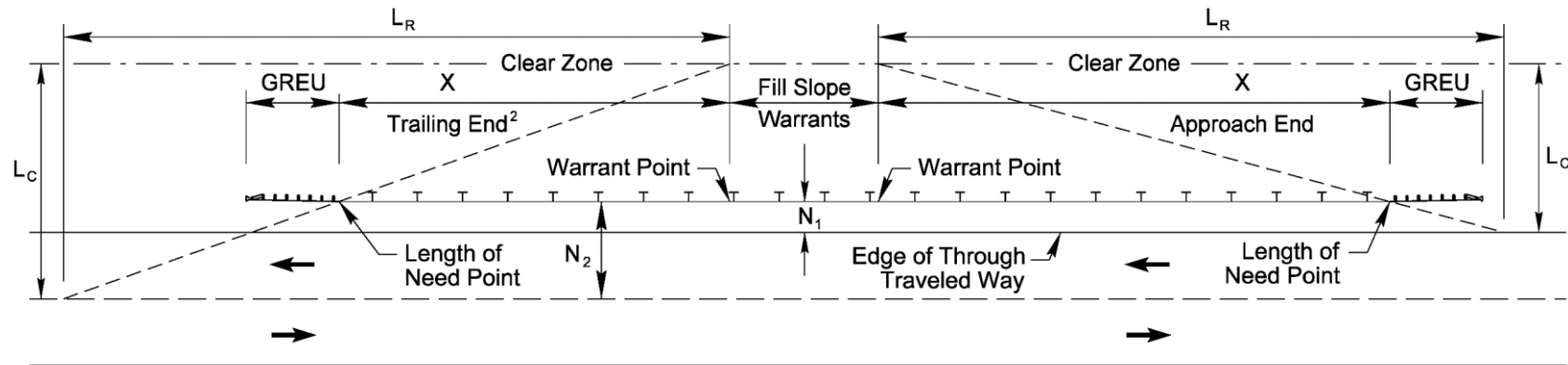

Notes:

1. Typically, the fill slope warrant point is at the location where the fill slope becomes steeper than 3:1 (or 4:1 if a hazard is present at the bottom of the slope). Refer to RDG Chapter 5 Section 5.2.1 Figure 5-1b for further detail.
2. For the trailing end, if the offset from the trailing end barrier to the edge of travel lane is equal to or greater than the clear zone ( $L_C$ ), a CAT-1 anchor unit can be used and be placed 25' beyond the end of the guardrail warrant point.

$$X = \frac{L_C - N}{L_C/L_R}$$

### 6.3.4 Placement on Approach End of a Hazard Located on a Curve

Figure 6-1 through Figure 6-3 are applicable to tangent alignments. Use Figure 6-4 when either a rigid obstacle or fill slope hazard exists on a curved alignment.

On curved alignments, a vehicle which leaves the roadway will generally follow a tangential runout path. Therefore, extend the tangent runout from the edge of the travel lane to either the area of concern ( $L_A$ ) or clear zone distance ( $L_C$ ). Add the guardrail end unit to the length of need to obtain the total guardrail length.

Figure 6-4 Detail of Guardrail Placement on Approach End of Hazard Located on Horizontal Curve

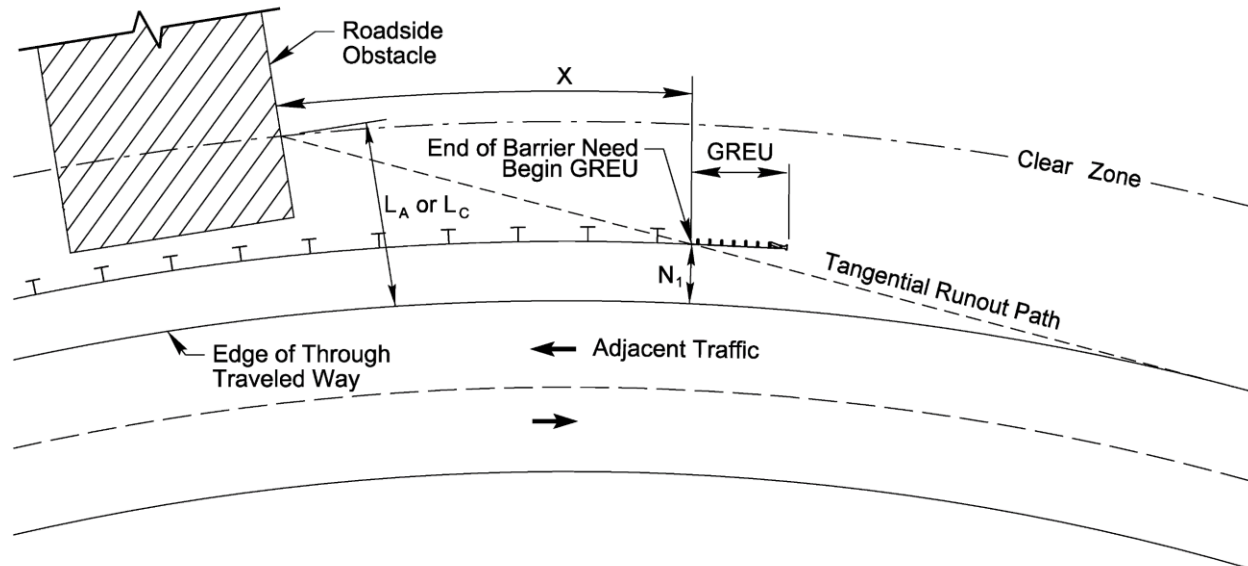

Note: Use  $L_A$  if the roadside obstacle is contained within the limits of the clear zone. If the roadside obstacle extends beyond the limits of the clear zone,  $L_C$  shall be used.

### 6.3.5 Placement for Median Breaks

In general, provide median guardrail breaks for maintenance and emergency vehicles at 1-mile intervals. The minimum width of the median break is 20 feet. Discuss locations and width of access breaks with Division personnel at the Field Inspection.

Refer to [NCDOT Roadway Standard Drawings](#) Std. No. 862.01 Sheet 7 for guardrail placement.

### 6.3.6 Placement at Intersections

When installing guardrail around intersections, take care to ensure adequate sight distance is maintained at the intersection. The guardrail should not impede the turning path of a vehicle. When guardrail is warranted around an intersection, provide as much offset as possible from the edge of the travel lane to the face of the guardrail. This will ensure adequate sight distance and place the guardrail farther from a vehicle's turning path.

In installations along curb and gutter facilities, place the guardrail preferably 12 feet from the face of the curb instead of at the face of the curb. When guardrail is placed at the face of the curb, sight distance and the vehicle's turning ability is impeded.

Refer to [NCDOT Roadway Standard Drawings](#) Std. No. 862.01, Sheet 8, for a pictorial view showing placement of guardrail at intersections.

### 6.3.7 Placement on -Y- Lines and Interchange Bridges

Consider the addition of guardrail where warranted throughout the construction limits along a -Y- line. Remember lower speeds on the -Y- line may negate the need for guardrail.

Whenever guardrail is used to shield bridge ends on -Y- lines with three or more lanes, no guardrail is warranted on the trailing end of the bridge when fill slopes are 4:1 or flatter. The elimination of the guardrail on the trailing end of the bridge will improve sight distance at ramp intersections, which are downstream of the bridge.

### 6.3.8 Placement Adjacent to Curb and Gutter

Placement of guardrail adjacent to curb and gutter warrants careful consideration as the trajectory of the vehicle will be altered when the vehicle impacts the curb and gutter. The type of curb and gutter, vehicle speed, vehicle angle of impact, and vehicle characteristics will all influence the vehicle trajectory. Placing the guardrail flush with the back of the curb and gutter allows the guardrail to work before the vehicle trajectory is altered. Placement of the guardrail farther from the curb and gutter allows the vehicles suspension to settle the vehicle trajectory before impact with the guardrail.

- Fill Height and Slope Warrant, Preferred Placement – The preferred treatment is to place the face of the guardrail 8 feet minimum from the face of the curb. The 8-foot minimum distance allows the vehicle's bumper to return to normal height before impacting the guardrail at design speeds less than 45 mph. Use a 13-foot minimum distance from the face of the guardrail to the face of the curb for design speeds from 45 to 50 mph. This placement method also accommodates sidewalk installation. Place the guardrail behind the sidewalk.
  - Add 2 feet of additional berm width behind guardrail. Refer to [NCDOT Roadway Standard Drawings](#) Std. No. 862.01 for details on this placement.
- Fill Height and Slope Warrant, Alternative Placement – When right of way restrictions prohibit the use of the preferred treatment, place the guardrail so the face of the guardrail aligns with the back of the curb. If sidewalk exists or is proposed, the sidewalk may have to be flared at the anchor unit installation. Refer to [NCDOT Roadway Standard Drawings](#) Std. No. 862.01 for details on this placement.

High speed facilities frequently require a gutter and guardrail combination on outside shoulders to control surface drainage and reduce erosion of fill slopes. Only use the expressway gutter and guardrail combination when the Hydraulics Unit recommends it on freeways with three or more lanes of pavement sloped in the same direction. The situation generally occurs on the low side of a superelevated curve in a fill section. Use the shoulder berm gutter and guardrail combination to meet this requirement at all other locations.

Refer to RDG Chapter 3 Section 3.4.1 and Chapter 5 Section 5.6.2.1 for additional information on curb and gutter and guardrail placement.

### 6.3.9 Placement Under Bridges

1. With Outside Bridge Piers
  - a. With a Concrete Barrier
    - i. If the outside pier is 15 feet 6 inches or less from the edge of the main travel lane, use a concrete barrier and guardrail [NCDOT Roadway Standard Drawings](#) Std. No. 857.01.

- ii. Extend the guardrail from the concrete barrier according to the length of need requirements as outlined in Section 6.2.2 above.
  - b. Without a Concrete Barrier
    - i. If the face of the bridge pier is greater than 15 feet 6 inches from the edge of the main travel lane but within the clear zone, use guardrail to protect the pier. The face of the guardrail will normally be placed 5 feet 6 inches from the face of pier, but usually no less than 12 feet from the edge of the main travel lane. Refer to [NCDOT Roadway Standard Drawings](#) Std. No. 862.01, Sheet 1.
    - ii. Extend the guardrail based on the length of need requirements as outlined in Section 6.2.2 above.
- 2. Without Outside Bridge Piers
  - a. Approach with a Natural or False Cut
    - i. No guardrail is needed if the 6-foot vertical curve is used with [NCDOT Roadway Standard Drawings](#) Std. Nos. 225.07 and 610.03.
  - b. Approach in a Fill without a False Cut
    - i. Guardrail is normally placed 6 feet to 12 feet from the edge of a local, collector, or auxiliary lane, and 12 feet to 20 feet from the edge of a main travel lane. Guardrail spacing at the end bent slope will typically be 6 feet 3 inches. Extend the guardrail based on the length of need requirements as outlined in Section 6.2.2 above.
- 3. With Curb and Gutter
  - a. Review curb and gutter facilities to determine if protection of bridge piers is required. Place the guardrail so the face of the guardrail aligns with the face of the curb.

### 6.3.10 Placement on Proposed Structures/Culverts

Refer to RDM Part I Chapter 5 for additional information on guardrail end units on structures.

Refer to [NCDOT Roadway Standard Drawings](#) Std. Nos. 857.01, 862.01, and 862.03.

### 6.3.11 Placement on Bridge Approaches

Place the guardrail at the back of the sidewalk so that it ties directly into the bridge rail as shown on [NCDOT Roadway Standard Drawings](#) Std. No. 862.01 Sheet 4.

Coordinate with the Structures Management Unit to determine the type of bridge rail to be used. Typically, a Type III Guardrail End Unit to anchor the guardrail to the end of all bridges with sidewalk. Refer to [NCDOT Roadway Standard Drawings](#) Std. No. 862.03, Sheet 2.

### 6.3.12 Placement on Existing Structures

Coordinate guardrail attachments required at existing bridges with the Structure Design Lead assigned to the project. If the project has not been assigned to a Structure Design Lead, coordinate with the Structures Management Field Operations Project Engineer.

The [Structures Management Unit Design Manual](#) contains examples of guardrail attachment used on previous projects; see Figures 6-32, 33, 34 and 35. If a required detail is not in the

manual, the Structure Design Lead will prepare the detail and the finalized detail will be sent to the Engineering Development Section in the Structure Design Unit for distribution. At times, measurements from the Bridge Maintenance Unit will be necessary before the details can be finalized.

Note: The Structure Design Lead is responsible for determining the appropriate design detail to be used or if a new design is required.

### 6.3.13 Temporary Guardrail Placement

During construction, maintain the clear zone and recovery area in accordance with the RDG. If this cannot be achieved and the hazardous situation will be temporary, protect the area with temporary guardrail or temporary concrete median barrier. Note that guardrail should be lapped in the direction of traffic. If the direction of traffic changes, the guardrail will need to be re-lapped in the new direction.

For a two-way road, add a 2-foot width to the shoulder for clear roadway width and an additional 2-foot width for placement of the guardrail.

In areas where guardrail or median barrier is placed in close proximity to the travel lane, take special care to avoid creating an unpaved drop-off area between the edge of the paved shoulder and the face of the barrier or guardrail.

## 6.4 Concrete Barriers

Due to its low cost, high durability, and effective performance, concrete barrier is the most common type of rigid barrier in use today. Concrete barriers vary in size, shape, and construction type. Depending on the location and use, concrete barriers can be cast in place, slip-formed, or precast. Common concrete barrier shapes are the New Jersey, single faced, and double faced. Refer to [NCDOT Roadway Standard Drawings](#) Std. Nos. 854.01, 854.02, 854.04, 854.05 and 857.01 for examples of these shapes.

Use “T” Type Double Faced Concrete Barrier (Std. No. 854.02) on all interstates and freeways with truck traffic exceeding 250 DDHV.

Refer to RDM Part I Chapter 6 Section 6.8, RDG Chapter 5 Section 5.4.1.12 and RDG Chapter 6 Section 6.4.1.8 for more details on concrete barriers and their selection.

### 6.4.1 Positively Anchored Temporary Precast Concrete Bridge Barrier – Type S

During staged construction, widening, or specific rehabilitation projects, the Work Zone Traffic Control Engineer may require a temporary bridge rail. In general, the pay item for temporary bridge barrier will be a traffic control item. Close coordination between the Structures Lead, roadway designer, and Work Zone Traffic Control Engineer is extremely important.

Adhere to the following procedures:

1. The Structures Lead will contact the roadway designer and the Work Zone Traffic Control Engineer to determine the width of the bridge deck needed to maintain traffic during construction. This will determine the location of the temporary barrier. The offset distance shall be the distance from the back of the barrier to the edge of the slab.
2. If the offset distance is from 0 feet to 3 feet 11 inches, anchor the Type S barrier positively to the slab. The roadway designer will include the detail of the Type S barrier in their plans. This barrier will be a Traffic Control pay item. The Work Zone Traffic Control Engineer will be responsible for determining pay limits and estimating pay item



quantities for the Engineer's estimate. The structure designer will include a sketch of the Type S barrier with the offset distance dimensioned and a note to see the Traffic Management plans for location and pay items of the positively anchored temporary precast concrete bridge barrier - Type S.

- a. The Structure Design Project Group Engineer will furnish the beginning and ending approach slab stations to the Work Zone Traffic Control Engineer and the roadway designer.
3. If the offset distance is from 4 feet to 5 feet 11 inches, use the standard precast temporary concrete median barrier found in [NCDOT Roadway Standard Drawings](#) Std. No. 1170.01.
  - a. The structure designer will furnish the beginning and ending approach slab stations to the Work Zone Traffic Control Engineer and the roadway designer. This will be used to determine the pay limits for the barrier. The Work Zone Traffic Control Engineer will put the following note in their plans.
    - i. THE TEMPORARY PRECAST MEDIAN BARRIER ON THE BRIDGE SHALL BE RESTRAINED AGAINST LATERAL MOVEMENT BY THE ANGLE AND ANCHOR SYSTEM. SEE THE BRIDGE PLANS FOR DETAIL AND PAYMENT FOR THE ANGLE AND ANCHOR SYSTEM.
4. If the offset distance is 6 feet or greater, use the standard precast temporary concrete median barrier found in [NCDOT Roadway Standard Drawings](#) Std. No. 1170.01. No attachment to the bridge deck is required. This will be a Traffic Control pay item.
5. If a bridge member is over stressed due to the use of the barrier specified in procedures 1, 2, or 3, the Structure Design Project Group Engineer will coordinate with Work Zone Traffic Control Engineer and roadway designer to use an alternate type of rail.

## 6.5 Cable Barriers

Cable barrier, or cable guiderail, is a roadside barrier that consists of steel cable mounted on weak posts. The primary use of cable barrier is placement in highway medians to prevent head-on collisions. There are two types of cable barrier systems: low-tension and high tension. Though each system has advantages and disadvantages, in general, a high-tension system has lower long-term maintenance costs but a higher initial cost. Only approved cable barrier systems are allowed on NCDOT projects.

For information on cable guiderail details and placement, see [NCDOT Roadway Standard Drawings](#) Std. No.865.01 Section 6.8 Median Barrier Selection.

## 6.6 Safety vs. Cost Guidance

The installation of roadside safety devices requires weighing the cost of the installation and maintenance of the safety device against the risk of injury or death of the motorist.

Perform a benefit cost analysis as part of the final safety barrier determination.

For more information on this subject see [NCHRP Report 492 – Roadside Safety Analysis Program \(RSAP\)- Engineers Manual](#).

## 6.7 Guardrail and Guiderail Summaries

The guardrail summary provides details on guardrail placement and guardrail quantities. Place a guardrail summary in all plan sets for projects where guardrail is used. Note that a guardrail summary is also used for concrete barrier and temporary guardrail locations. A separate summary is usually provided for cable guiderail. For more information on the details provided in these summaries see RDM Part II, Chapter 13 Section 13.7.1.2.

## 6.8 Median Barrier Selection

Depending on the situation, steel beam guardrail, cable barrier, or concrete barrier may be used in the median to protect motorists from rigid obstacles, bridge abutments, errant vehicles crossing the median or other obstacles that present a hazard to the motorist. Place steel beam guardrail on 10:1 or flatter slopes.

This determination is based on the following conditions:

- Median width
- Bridge abutments
- Existing conditions
- NCDOT Division preference

NCDOT requires median guardrail, guiderail, or barrier on all interstate and freeway projects with median widths of 70 feet or less.

Standard double-faced concrete barrier is commonly used when the median is less than 30 feet in width. Consult the [State Plans and Standards Engineer](#) in the Contract Standards and Development Unit to obtain details or approval for special concrete median barrier.

Refer to Table 6-2 for guidance on selecting standard double-faced concrete median barrier.

**Table 6-2 Standard Median Concrete Barrier Types**

Barrier Type	Standard Drawing	Application
Type I	854.01	Glare screen permitted Freeways with truck traffic less than 250 DHV Arterials, collectors, and local roads
Type II	854.01	Glare screen permitted Grade-separated median Variable height Freeways with truck traffic less than 250 DHV Arterials, collectors, and local roads
Type III	854.01	No glare screen permitted Grade-separated median Variable height Freeways with truck traffic less than 250 DHV Arterials, collectors, and local roads
Type IV	854.01	No glare screen permitted Freeways with truck traffic less than 250 DHV Arterials, collectors, and local roads

Barrier Type	Standard Drawing	Application
Type T	854.02	Freeways with truck traffic over 250 DHV
Type T1	854.02	Grade-separated median Variable barrier height (51 inches to 63 inches) Freeways with truck traffic over 250 DHV
Type T2	854.02	Grade-separated median Variable barrier height (68 inches to 92 inches) Freeways with truck traffic over 250 DHV
Single Slope Concrete Barrier	854.07	Grade-separated median Variable barrier height (48 inches to 54 inches) Freeways with truck traffic over 250 DHV

Note: MSE wall fill details provided by the Design Geotechnical Engineer or Structures Lead, or both.

## 6.8.1 Guidelines for Typical Median Guardrail or Guiderail Installation

### 6.8.1.1 Types of installations to be used

Use low tension cable guiderail (LTCG) or steel beam guardrail with post spacing (semi-rigid guardrail) of 6 feet 3 inches when slopes of 6:1 or flatter exist in the median. LTCG deflects up to 12 feet. When using cable guiderail, the designer will verify the deflection of the rail does not extend into the opposing travel lane. High tension cable guiderail systems (HTCG) have lower deflections (5 feet 8 inches) than LTCG systems. Use HTCG in areas where lower deflections are needed in the median or on the outside shoulder. HTCG systems are proprietary. HTCG systems must be on the NCDOT Approved Products List and may be used at the approval of Division personnel or the State Roadway Design Engineer. Install all HTCG systems per the manufacturer's instructions.

Steel beam guardrail must be placed on 10:1 or flatter slopes. When using steel beam guardrail to protect from rigid obstacles, ensure the face of the guardrail is placed 5 feet 6 inches from the face of the hazard. Refer to offset distance note on [NCDOT Roadway Standard Drawings](#) Std. No. 862.01,.

Use weak post steel beam guardrail in freeway medians that have adjoining segments of weak post guardrail in place at each end of the project. Currently, NCDOT is not proposing to use weak post guardrail in any other locations. This guardrail is flexible and has post spacing of 12 feet 6 inches. The normal deflection of this guardrail is 7 feet. Weak post guardrail must be placed on slopes 10:1 or flatter.

Place the guardrail as far from the edge of the travel lane as the above guidelines will allow.

### 6.8.1.2 Typical Barrier Placement for Various Median Widths

Table 6-3 Typical Barrier Placement for Various Median Widths

Less than 30 feet:	Use double-faced concrete barrier. (Extend paved shoulder width to the face of the barrier.)
30 feet:	**Typically, use two rows of semi-rigid guardrail. (Assuming slopes steeper than 6:1 exist in the median)
36 feet:	**Two rows of semi-rigid guardrail if slopes are steeper than 6:1. One line of cable guiderail (approximately 4 feet from the centerline of the ditch) if median slopes are 6:1 or flatter.

46/51 feet:	One line of cable guiderail if slopes are 6:1 or flatter. (Place approximately 4 feet from the centerline of the ditch). **Two lines of semi-rigid guardrail if slopes are steeper than 6:1.
60 feet and above:	One line of cable guiderail placed approximately 8 feet from the center of the ditch.

Note: \*\*If two lines of guardrail are required, place semi-rigid guardrail. (The two lines of steel beam guardrail should not pose as much maintenance problems as two lines of cable guiderail.)

The above are guidelines only and will not cover every possible situation. Study and evaluate each location in conjunction with the previous information to determine an appropriate median guardrail treatment.

[NCDOT Roadway Standard Drawings](#) have not been developed for the following conditions. These conditions can be detailed on the plan view itself.

### 6.8.1.3 Two Rows of Semi-Rigid Guardrail at Median Piers (30'-36' MED)

Use semi-rigid guardrail to serve as pier protection for median widths ranging from 30 to 36 feet. Ensure the semi-rigid guardrail (with 3-foot 1.5-inch post spacing) can be placed at a minimum distance of 3 feet 6 inches from the face of the bridge piers. (See [NCDOT Roadway Standard Drawings](#) Std. No. 862.01, Sheet 1 which describes minimum offset to piers.

### 6.8.1.4 Use of Cable Guiderail with Earth Berm Protection

Use earth berm protection in median widths of 68 feet and 70 feet. Guardrail is not required in medians wider than 80 feet when the bridge pier is located in the center of the median.

When using the earth berm, stop the cable guiderail at an approximate distance of 225 feet from the beginning of the concrete slope protection. Note that if the earth berm is not feasible or cost effective, concrete barriers, guardrail, guiderail or impact attenuators should be used.

Refer to [NCDOT Roadway Standard Drawings](#) Std. No. 225.08 for Earth Berm Protection. Stop the guiderail between sections D and E as shown on the standard. Provide a distance of 225 feet from the concrete slope protection as calculated from [NCDOT Roadway Standard Drawings](#) Std. No. 225.08.

### 6.8.1.5 Special Median Grading for Median Barriers

Placement of median barriers (concrete barrier, guardrail, and cable barrier) requires special grading for the barrier systems to function properly. The following information provides guidance the roadway and hydraulics engineers must consider when placing median barriers in the median.

Special grading in superelevated locations shall have standard median shoulder slopes (refer to [NCDOT Roadway Standard Drawings](#) Std. Nos. 560.01 and 560.02). Use a 10:1 slope from the higher median shoulder break point to establish the elevation at the center of the median. Next, extend a slope from the lower median shoulder break point to the center of the median elevation, as established above, to complete the median cross section (See Figure 6-5 below).

Highway plans, with special median grading (see Figure 6-5 below), submitted to the hydraulics engineer shall include information as follows:

- Modified Cross Sections as specified by [NCDOT Roadway Standard Drawings](#) Std. No. 225.08, Sheet 1; Std. No. 862.01, Sheet 1; Std. No. 862.01, Sheet 2; and Std. No. 865.01, Sheet 2.

- Cross reference the plan sheets to the applicable standard by showing “Note: See Cross Sections and [NCDOT Roadway Standard Drawings](#) Std. No. \_\_\_\_\_, Sheet \_\_\_\_\_ for Special Median Grading.”
- Show guardrail and impact attenuators requiring special grading. Use the longest impact attenuator permitted by the Special Provisions for grading limits.
- Label beginning and ending of special grading on plan sheets.

Inform the hydraulics engineer of altered drainage patterns or low points created by the special median grading.

Figure 6-5 Special Grading in Superelevated Location

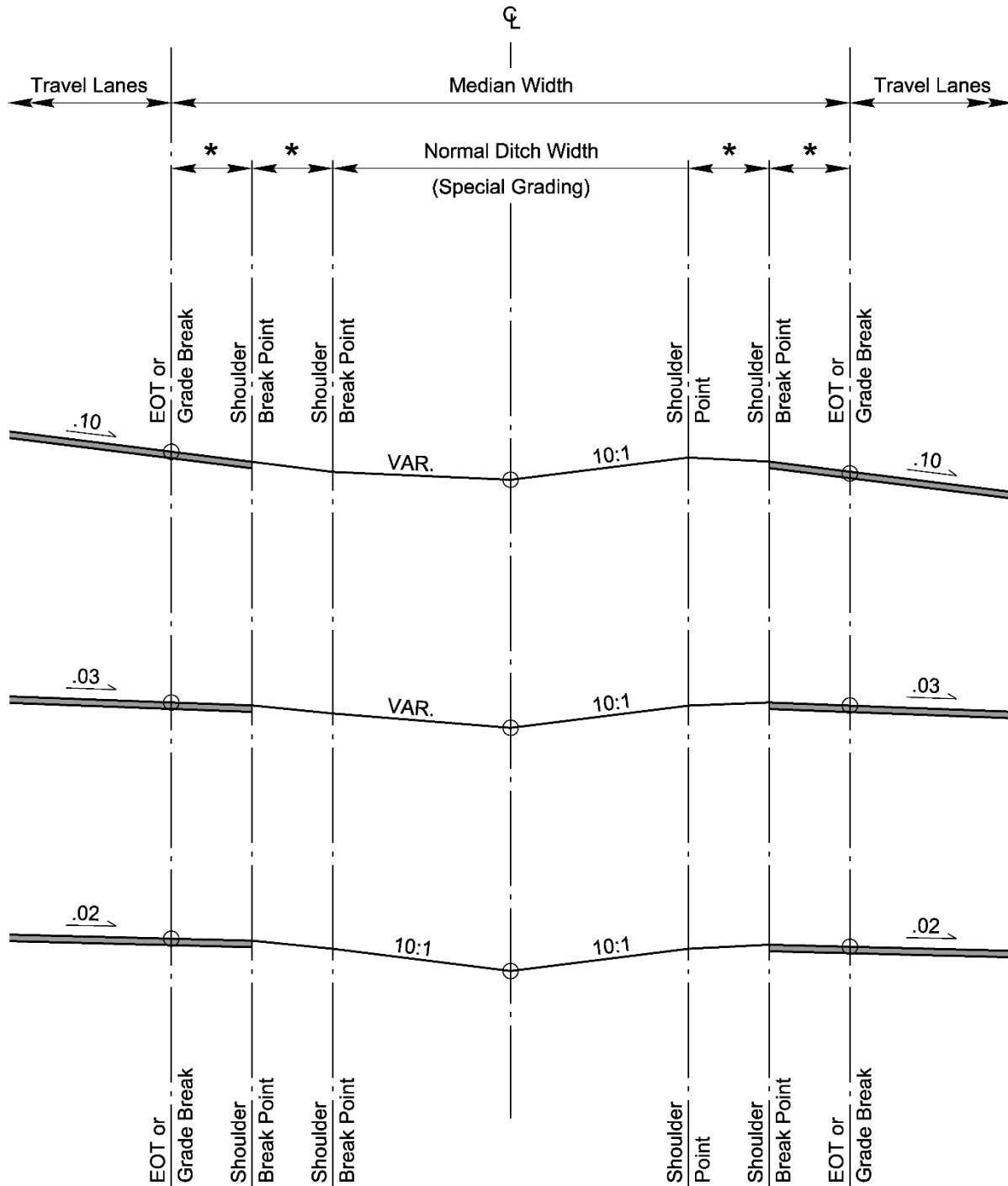

Notes:

1. (★) = Median shoulder width.
2. See NCDOT Roadway Standard Drawings Std. No. 560.01 and 560.02 for method of shoulder construction.

Note that this special grading in superelevated location (Figure 6-5) will apply to locations that do not require traffic barriers.

RDG Chapter 6 Figure 6-1 provides median width guidance on when a median barrier is recommended.

[NCDOT Roadway Standard Drawings](#) Std. Nos. 854.01, 854.02, 854.04, 854.05, 857.01, 862.01 and 865.01 provide details on the proper placement of safety barriers in the median and under bridges (median and outside shoulders). Other types of concrete median barriers, such as single slope, F-shape, and flat faced, may be used as approved by the State Roadway Design Engineer. All alternative concrete median barriers must meet current AASHTO and FHWA crash testing requirements.

Follow [NCDOT Roadway Standard Drawings](#) Std. Nos. 560.01 and 560.02 for special grading for medians in superelevation.

Refer to RDG Chapter 6 and GB Chapter 4 Section 4.10.2.2 for more information on median barriers.

## 6.9 Guardrail End Units

The following are commonly used end units with a brief description.

- Guardrail End Unit Test Level 2 and Test Level 3 (GREU-TL-2 and TL-3) – The GREU TL-2 and TL-3 are tangential end units used parallel to the travel way. Flare these units to provide a 1-foot offset. GREU-TL-2 (25 feet long) can be used when design speeds are less than 50 mph. GREU TL-3 (50 feet long) can be used when design speeds are 50 mph or greater.
- Cable Anchor Terminal: (CAT-1) – The CAT-1 end treatment is not crashworthy and should only be used at locations where there is not an opportunity to have a head-on hit within a vehicle's clear zone. A CAT-1 unit is typically placed on the trailing end of a run of guardrail.
- Anchor Terminal (AT-1) – Use of the AT-1 is limited to anchoring the shop curved guardrail at intersections which have radii between 20 feet and 75 feet.
- Impact Attenuators (varies) – The impact attenuator or crash cushion is used to protect roadside objects that cannot be moved. Typical impact attenuator lengths range between 20 feet and 50 feet. Refer to the NCDOT [Approved Products List](#) to find current available products.
- Gating vs. Non-gating Attenuators – Gating describes an attenuator that folds (acts like a gate) and allows the vehicle to slow down in the clear zone. These are applicable when there is sufficient clear zone for the vehicle to come to a stop. The clear recovery area on each side of the gating unit has to be a minimum of 30 feet. Use a non-gating attenuator if a clear recovery area of 30 feet is not available.
  - Non-gating describes an attenuator that, when impacted from the front of the system, does not allow a vehicle to pass into the clear zone. A clear zone still exists, but it is usually smaller. These types of attenuators are generally used in medians or where the full clear zone is not possible.
- Structure Anchor Units:
  - Type III – Use this anchor unit to anchor guardrail to bridges with metal bar railing or any other rail design with a vertical concrete railing or parapet allowing the Type III attachment. See [NCDOT Roadway Standard Drawings](#) Std. No. 862.03.

- Type B-77 (with rubrail) – Use this guardrail end unit to attach guardrail to concrete Jersey or F-shape barrier as illustrated in [NCDOT Roadway Standard Drawings](#) Std. No. 862.03.
- Type B-83 – Use this end unit on existing bridges with a Jersey shape barrier and an 8-inch or higher curb on the approach slab. See [NCDOT Roadway Standard Drawings](#) Std. No. 862.03.
- Terminal End Section (TES) – The terminal end section must not be used parallel to traffic as it is not crashworthy in that application. It is a system part typically used for guardrail placed perpendicular to traffic at a dead end situation, i.e. a cul-de-sac, to prevent errant traffic from causing damage to the adjacent property or creating an unsafe situation. See NCDOT Roadway Standard Drawings Std. No. 862.02.

Refer to [NCDOT Roadway Standard Drawings](#) Std. Nos. 862.01, 862.02, 862.03 and RDG Chapters 7 and 8 for more detailed information on bridge railing and end treatments.



# Chapter 7 Drainage

The main factors to consider in roadway drainage design are traffic safety, potential for property damage from flooding, roadway functionality, environmental impacts, and maintenance. Bridges, box and pipe culvert crossings, channels, gutters, storm sewer systems and stormwater best management practices are some of the design elements used to collect, manage, remove water from the roadway and convey it across the right of way. The information in this chapter provides an overview of the most important aspects regarding drainage of transportation facilities.

## 7.1 Drainage Considerations for Strategic Transportation Corridors

Roadways that have been identified as Strategic Transportation Corridors (STC) may require more rigorous drainage design criteria than expected based solely on their functional classification, thus it is critical to coordinate with the hydraulics engineer when setting the initial roadway grade. The criteria for these STC may require larger drainage structures for larger design storm events, may affect the required minimum and maximum roadway vertical grade, may require extending the project limits, and may result in the need for additional right of way acquisition. Design for STC functional standards may also result in additional environmental impacts, an increased cost estimate, or a combination of any of these factors.

Refer to the [NCDOT Strategic Transportation Corridor](#) site for more information regarding STC classification and STC maps.

## 7.2 PDN Process and Drainage Design

Maintain ongoing communication with the hydraulics engineer throughout the different stages of the NCDOT PDN process, since roadway design changes may affect the hydraulic design, and vice versa.

### 7.2.1 Alignment Defined PDN Stage 2

Coordinate early in the process with the hydraulics engineer when establishing the horizontal and vertical roadway alignment. The hydraulics engineer will prepare the preliminary hydraulic recommendations which include any preliminary bridge or culvert reports, or a hydraulics memo stating whether the proposed roadway grade is hydraulically controlled. For instance, if the existing hydraulic structure is at or below the existing base flood elevation, raising the existing roadway grade may have significant effects on the existing base flood elevations upstream and cause flooding. A larger proposed hydraulic opening may mitigate for raising the grade, but this is not guaranteed. Getting to an acceptable roadway grade and proposed structure combination is an iterative process.

In addition, consider the type of permits and the agencies that will be involved with the project to include any additional time required for the permit application processes when developing the project schedule. Environmental permitting involving jurisdictional streams, wetlands and riparian buffers, Coastal Area Management Act (CAMA) permits, Federal Emergency Management Agency (FEMA) and North Carolina Floodplain Mapping Program (NCFMP) permitting are some of the permit applications that may take a significant amount of time for approval. For example, streams crossings not included in a FEMA study may only require approval from the NCDOT Hydraulics Unit. Whereas stream crossings included in a FEMA

study may need to be coordinated through NCDOT's Highway Floodplain Program and may also need approval from NCFMP or FEMA. These NCFMP/FEMA permit approvals may take 4 to 6 months and sometimes longer.

### 7.2.2 Plan-in-Hand PDN Stage 3

Discuss with the hydraulics engineer any revisions to the roadway design, since these may affect drainage design and environmental permit drawings. Coordinate with the erosion control designer regarding the anticipated location and size of erosion control basins since this information is crucial for the development of right of way plans which include permanent and temporary construction easements. At this time, the transportation management plan is being finalized and any on-site temporary detours, if present, will require appropriate temporary detour drainage and erosion control measures, and potential modifications to hydraulic structures. The environmental permit drawings commence once the hydraulic design is approved.

### 7.2.3 Plans, Specifications and Estimate PDN Stage 4

During Stage 4, any hydraulics and erosion control open tasks are finalized, and the permit drawings are secured. Maintain ongoing communication with the hydraulics engineer and erosion control designer and inform them of any changes in roadway design that may affect both disciplines and the environmental permit drawings.

## 7.3 Vertical Clearance and Other Grade Considerations

### 7.3.1 Cut Ditch Sections

In cut ditch sections, a roadway grade flatter than 0.3 percent may be used as long as the ditches have a ditch slope greater than 0.3 percent. Maintenance is more important on flat gradients on uncurbed pavements to prevent the build-up of vegetation or debris along the edge of pavement that could result in a spread ponding situation.

### 7.3.2 Curb and Gutter Sections

For curb and gutter sections (and along median barrier sections), maintain a minimum grade of 0.3 percent at the edge of pavement. Although not desirable, minimum grades for drainage can be maintained in very flat terrain by use of a rolling profile or by warping the cross slope to achieve rolling gutter profiles. Superelevation and widening transitions at roadway intersections can result in a gutter profile that is very different from the centerline profile, creating sumps or ponding areas along the gutter. Identify and eliminate these areas early on in coordination with the hydraulics engineer.

### 7.3.3 Vertical Clearance for Pipes

Refer to the [NCDOT Pipe Material Selection Guide](#) for vertical clearance information for most commonly used pipes. The hydraulics engineer will verify the required minimum and maximum fill heights for other less commonly used pipe sizes not listed in the guide, such as corrugated steel or aluminum pipe arches, structural plate steel pipes, elliptical and arched concrete pipes.

Refer to Figure 7-1 for illustration of minimum pipe cover.

Figure 7-1 Minimum Pipe Cover Requirements

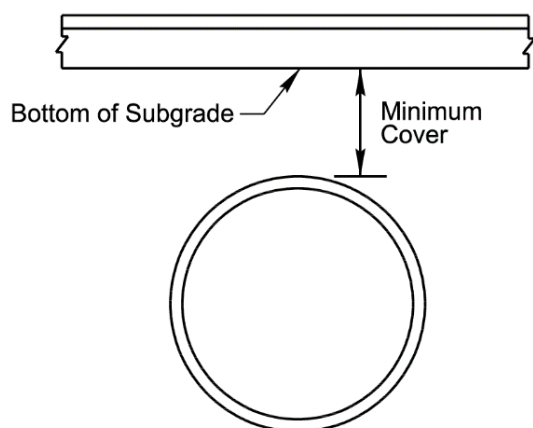

### 7.3.4 Vertical Clearance for Box Culverts

For NCDOT box culverts, the desired cover is 3 feet or more, measured from the top of the roof slab to the finished grade. For those instances when meeting the 3-foot cover criteria is not practical or cannot be met, provide as a minimum for full depth of pavement at all critical spots along the box culvert. Pay special attention to low spots on skewed pipe and box culverts.

Top slab thicknesses can vary, depending on the fill height. For example, under a given condition a 10-inch slab thickness may be needed whenever the cover is equal to 3 feet or more. However, design loads based on AASHTO typically increase as the depth of cover gets closer to 0 feet. The increased loading may result in an increased slab thickness, as thick as 18 inches in some cases. Increasing the slab thickness will further encroach upon the depth of cover as measured from the top of the roof slab to the finish grade.

Coordinate with both the structures and hydraulics engineers whenever low fill conditions may be encountered. A grade revision, alternate hydraulic structure, modified structural design, or a combination of all three options may be needed to find an appropriate solution. Also coordinate closely when temporary detours may limit vertical clearance requirements.

Refer to Figure 7-2 for illustration of minimum cover for boxes.

Figure 7-2 Minimum Box Culvert Cover Requirements

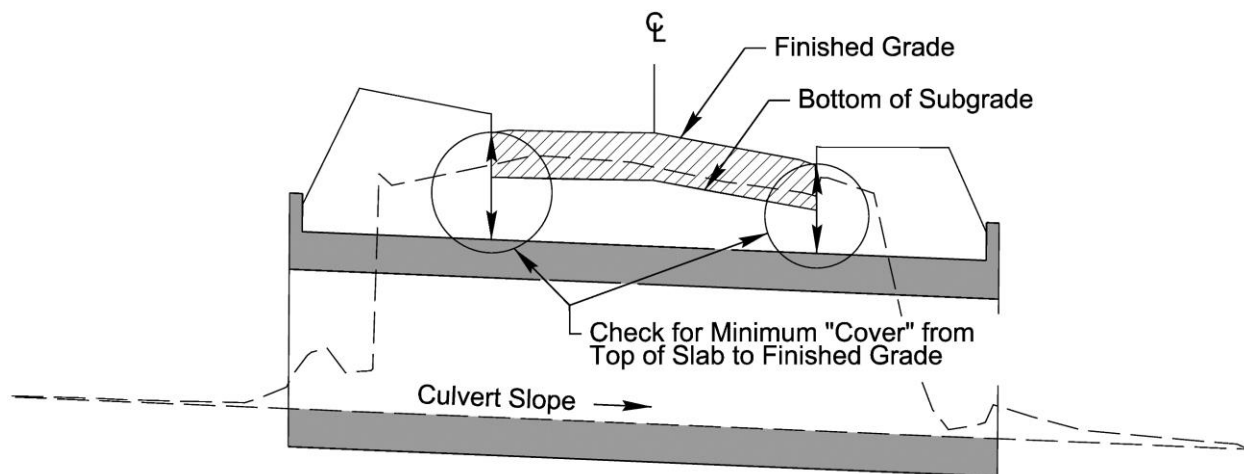

## 7.4 Skew Angle

The angle that a crossing pipe, bridge, box culvert, or other structure makes with the centerline of the roadway is measured in a clockwise direction from the centerline, line ahead. Refer to Figure 7-3 for illustration of skew angle designation.

- For box culverts and cross pipes, round to the nearest whole or half degrees preferably. Angle designation will vary as needed for hydraulics design and site restrictions.
- For bridges over streams, round to the nearest 5 degrees preferably.
- For cored slab or box beam bridges round to the nearest 15 degrees so that standard NCDOT bridge plans may be utilized.

Figure 7-3 Skew Angle Designations

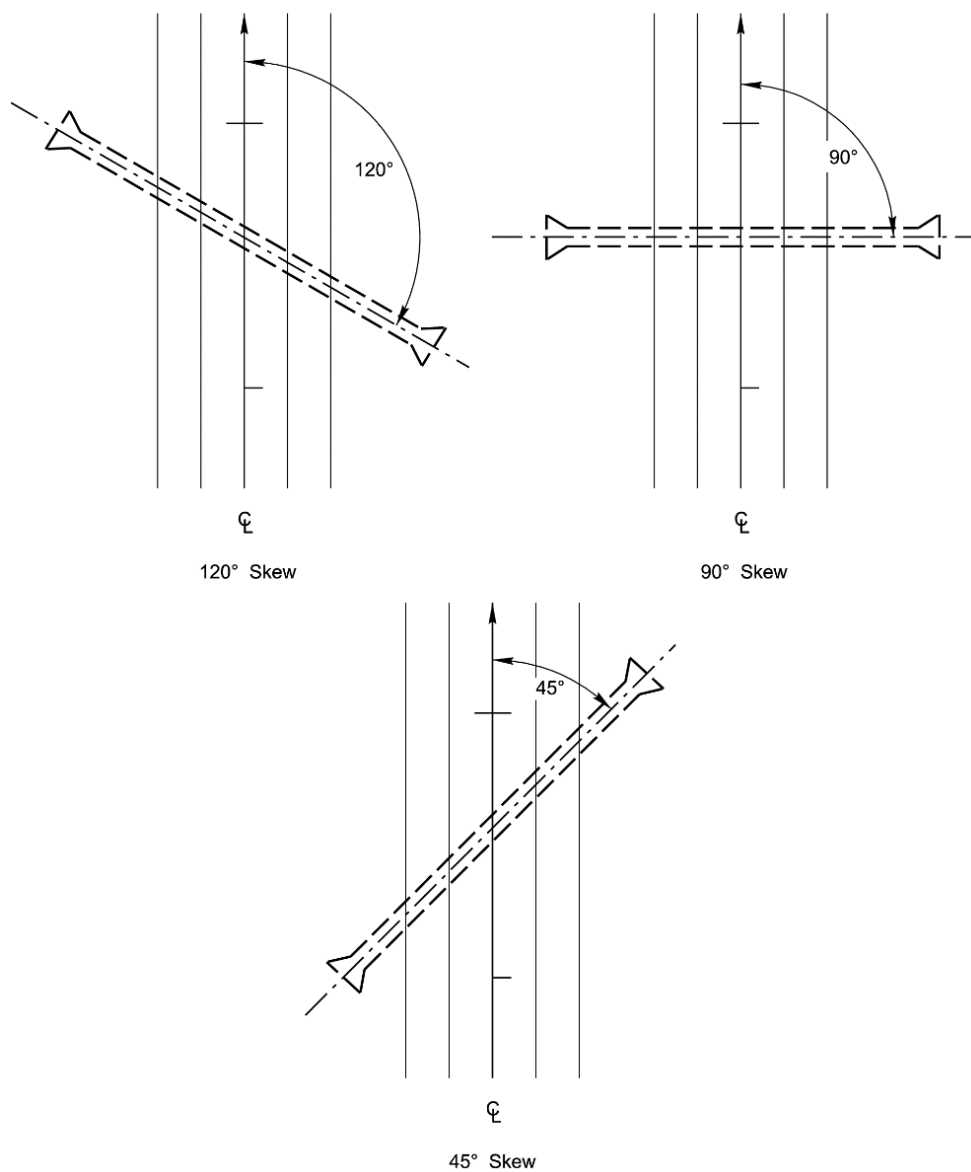

## 7.5 Pipe End Treatment

Pipe ends within the clear zone are considered a hazard for motor vehicles without an appropriate end treatment approach. The criteria to be used depends on the facility type and the design speed. Coordinate with the hydraulics engineer to discuss the pipe end treatment approach to be used for each road in the project.

Verify the pipe end treatments used are appropriate for the project after the hydraulics design is complete. Discuss with the hydraulics engineer any specific locations where a clear zone guardrail warrant can be eliminated by lengthening of pipes/culverts.

Refer to [NCDOT Roadway Standard Drawings](#) Std. Nos. 310.02, 310.03, 310.04, and 310.05 for parallel pipe and cross pipe end sections. Also refer to RDM Part I Chapter 4 Section 4.6.1.

These guidelines apply to new construction and major reconstruction projects on Interstate, US, and NC routes. They do not apply to resurfacing or secondary roads (SR). Pipe end treatment on those type of projects (including private pipe installation) will be the same as existing pipes unless accident history warrants special consideration.

Providing a clear roadside recovery area is desirable in all locations, but the design will be more compatible on projects with minimum access points. (For example, partial control of access projects or projects on new locations.) The RDG also provides guidance, but many of the recommended treatments are not typically used by NCDOT.

Sections 7.5.1 and 7.5.2 below apply to projects on the primary system and do not apply to those projects on the secondary road system. Recommendations are listed in order of preference; use the first recommendation under each heading if practical. Use engineering judgement to determine if a different but more appropriate treatment is necessary.

### 7.5.1 Pipe End Treatment for Cross Pipes

Refer to [NCDOT Roadway Standard Drawings](#), Std. Nos. 310.03 and 310.05.

#### 7.5.1.1 Cross Pipes Outside the Clear Zone

- For pipes 36 inches in diameter and greater, use endwall on inlet end unless the hydraulics engineer specifies otherwise. Equalizer pipes in wetlands and outside the clear zone area do not require headwalls.
- Pipes 30 inches in diameter and smaller do not require headwalls on either end unless the hydraulic engineer specifies otherwise.

#### 7.5.1.2 Cross Pipes Inside the Clear Zone

- For pipes 36 inches in diameter and greater, extend pipe beyond the clear zone recovery area when feasible and use endwall on inlet end unless hydraulics engineer specifies otherwise. Consider any impacts to jurisdictional areas when extending pipes beyond clear zone. Any additional backfill material necessary to extend this pipe is covered under Section 300 of the [NCDOT Standard Specifications for Roads and Structures](#).

If extending the pipe beyond the clear zone recovery area is not feasible, use guardrail with endwall on the inlet end. Protect with guardrail on the outlet end.

- For pipes 30 inches in diameter and smaller, extend pipe beyond the clear zone recovery area when feasible. If extending the pipe beyond the clear zone recovery area is not feasible, use a cross pipe end section with a 4:1 slope.

## 7.5.2 Pipe End Treatment for Parallel Pipes

Refer to [NCDOT Roadway Standard Drawings](#) Std. Nos. 310.02 and 310.04.

### 7.5.2.1 Parallel Pipes at Median Crossovers

- Use a grated drop inlet with 10:1 or flatter slopes.
- Use pipes 30 inches in diameter and smaller with parallel pipe end sections, and 6:1 slopes at existing locations without sufficient depth for a drainage structure.

### 7.5.2.2 Parallel Pipes at Grade Intersections

#### Multilane roadways with design speed greater than 50 mph

Recommendations are listed in order of preference.

- Place all pipes beyond the clear zone and use an endwall on the inlet end of pipes 36 inches in diameter and greater accordingly unless the hydraulics engineer specifies otherwise. Transition the roadway ditch accordingly.
- When placing pipes beyond the clear zone is not feasible, use a grated drop inlet with 6:1 or flatter slopes on the approach ends where practical and where existing or proposed drainage systems are available. Trailing ends do not require special treatment other than endwalls on the inlet end of pipes 36 inches in diameter and greater unless the hydraulics engineer specifies otherwise.
- When using a grated drop inlet on the approach ends is not feasible, then use a parallel pipe end section with 6:1 slope for pipes 24 inches in diameter and smaller and use guardrail for pipes 30 inches in diameter or greater. Trailing ends do not require special treatment other than endwalls on the inlet end of pipes 36 inches in diameter and greater unless the hydraulics engineer specifies otherwise.

#### Multilane roadways with design speed less than 50 mph and all two-lane roadways

Multilane roadways with design speed less than 50 mph and all two-lane roadways do not require special end treatment other than the use of an endwall on the inlet end for pipes 36 inches in diameter and greater unless hydraulics engineer specifies otherwise.

### 7.5.2.3 Driveways

Where feasible, locate the driveway pipe outside the clear roadside recovery area and transition the roadway ditch accordingly. Refer to Figure 7-4 for illustration of pipe location and clear roadside recovery area.

## 7.5.3 Endwalls

Construct the endwalls perpendicular to the centerline of the pipe unless specific site conditions warrant construction of an endwall parallel to the roadway. Coordinate with Hydraulics Unit for approval. Extend the pipe to allow the end of the endwall to tie into the toe of the fill.

Refer to Figure 7-5 for illustration of typical endwall treatment. Additional backfill material necessary to extend this pipe is covered under Section 300 of the [NCDOT Standard Specifications for Roads and Structures](#).

The quantities for the endwalls constructed perpendicular to the centerline of the pipe are based on a 90-degree skew rather than the skew of the pipe. On multiple pipe installations, provide additional pipe length such that a line projected along the face of the endwall is perpendicular to the centerline of pipes.

Figure 7-4 Clear Roadside Recovery Area for Access Roads

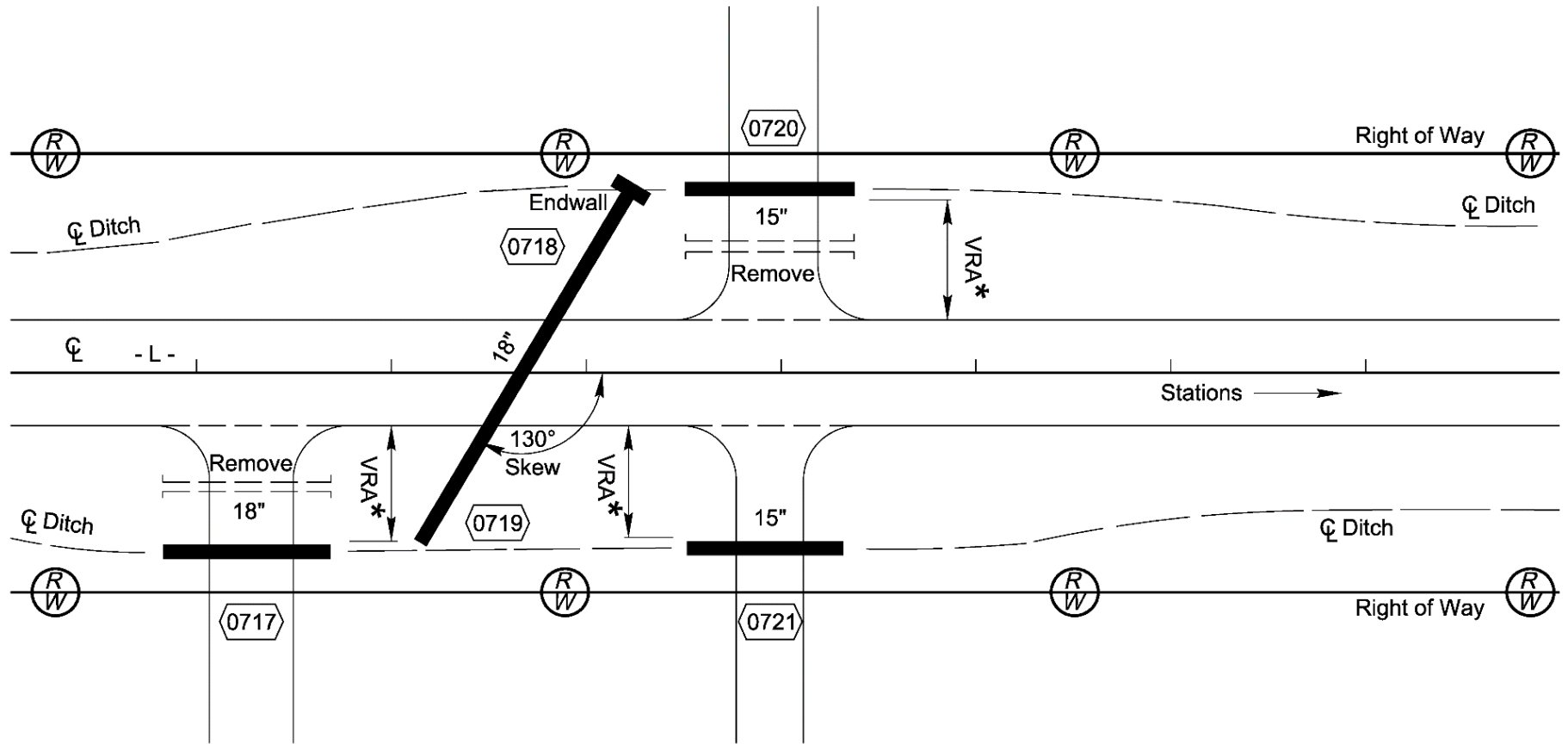

Note: VRA = Vehicle Recovery Area. Refer to RDM Part I Chapter 4 Section 4.6 for the definition of Vehicle Recovery Area.



Figure 7-5 Example of Endwall Treatment

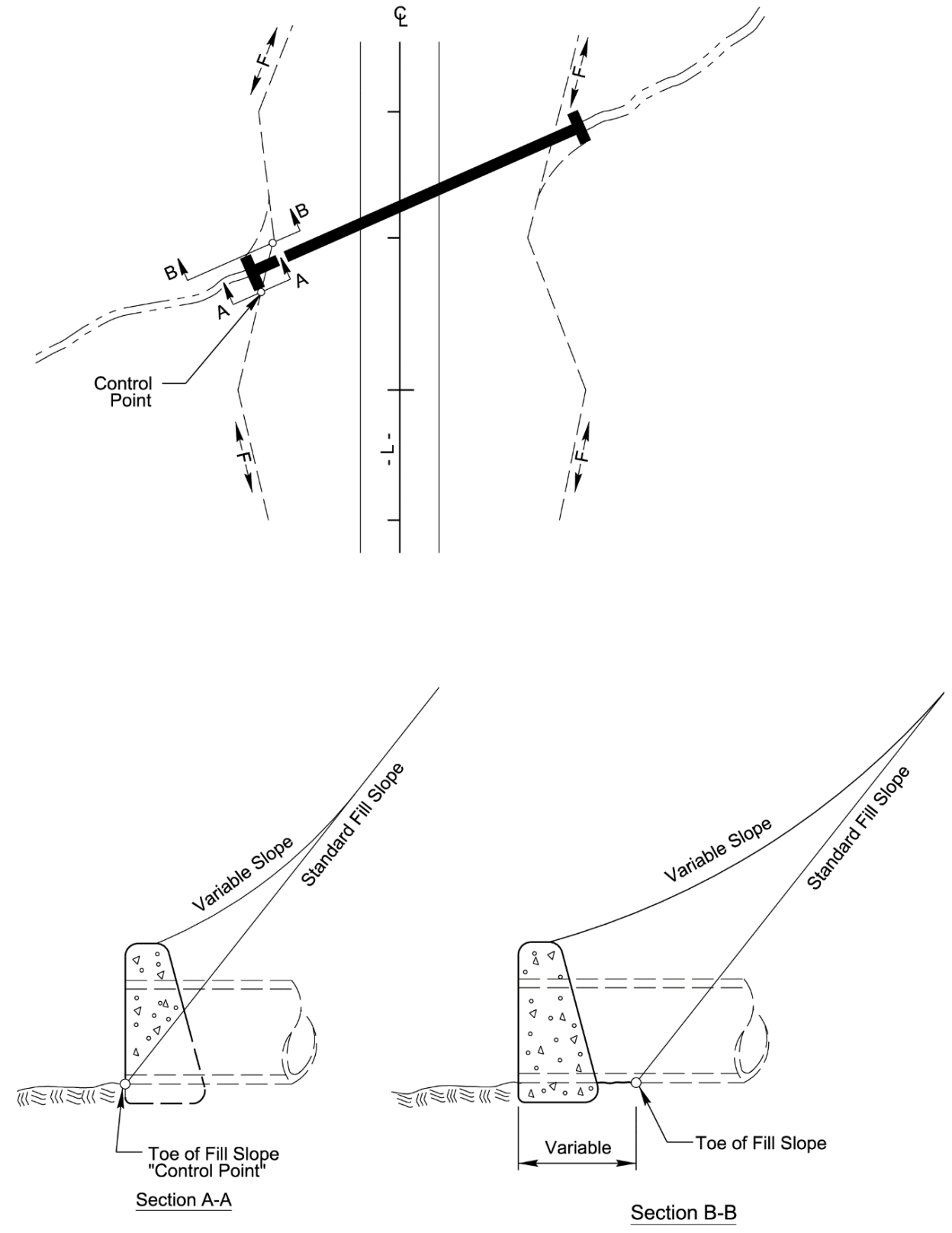

## 7.6 Drainage and Gutter Guidelines

There are times when the need for a gutter section is solely due to drainage or erosion control requirements. For instance, use shoulder berms, gutters and curbing on the outside edge of fill shoulders as recommended by the hydraulics engineer to minimize the shoulder and slope erosion resulting from sheet flow off the pavement.

### 7.6.1 Addressing Erosion on Existing Facilities

Coordinate with the hydraulics engineer and the geotechnical engineer to define the proper solution based on individual site conditions. When erosion at the curb on existing installations causes undermining of the curb and erosion of fill slopes, try the following:

- On existing facilities with 2-foot or 4-foot paved shoulders, remove the curb and stabilize the shoulder and slope.
- On 10-foot paved shoulder facilities, extend the paved shoulder to abut the curb.

### 7.6.2 Proposed Construction

Coordinate with the Division and hydraulics engineers regarding gutter placement when developing the typical sections for the project. Address the shoulder treatment during the preliminary field inspection and discuss water quality issues that may arise at that time.

Refer to [NCDOT Design Resources](#) page on the Connect NCDOT website for the most current listing of the Field Inspection Questions document.

#### 7.6.2.1 Shoulder Berm Gutter

Shoulder berm gutter is used in conjunction with guardrail, with the face of the rail directly above the flow line. Typically, diffuse flow is accomplished when surface water is allowed to flow across the shoulders and down the fill slope. However, simple grass cover cannot always prevent erosion of the embankment slopes and in those cases, it may be necessary to add shoulder berm gutter. The following conditions may warrant use of shoulder berm gutter:

- Presence of easily erodible soils or soils not conducive to vegetative growth along the shoulder and the embankment.
- Roadside development which might require stricter control of runoff.
- Potential for large runoff flow and velocity due to/or in combination with any of the following factors:
  - Pavement width (including paved shoulder) is 36 feet or greater flowing in one direction.
  - High embankments (over 20 feet) in combination with pavement width warrant.
  - Superelevated sections. Place shoulder berm gutter on the low side of superelevation.
  - Steep roadway grade in combination with pavement width warrant.

The hydraulics engineer will evaluate and indicate any other areas that may require shoulder berm gutter.

### 7.6.2.2 Expressway Gutter

Use expressway gutter when positive control of sheet flow is needed, and guardrail is not warranted. Expressway gutter is also used in cut sections where the right of way is not wide enough to accommodate the typical section. Expressway gutter used in combination with guardrail requires NCDOT Hydraulics and Roadway Units approval.

Refer to [NCDOT Roadway Standard Drawings](#) Std. No. 846.01.

### 7.6.2.3 Median Curbs

Coordinate early in the process with the hydraulics engineer since the recommended curb used will affect the typical section. The hydraulics engineer will make a recommendation based on the spread requirements for the facility. Several curb types are available depending on the type of facility and design speed.

Refer to [NCDOT Roadway Standard Drawings](#), Std. No. 846.01.

- 1-foot 6-inch curb and gutter is used along the edge of a raised median divided section, which could be either grass or concrete. The 1-foot 6-inch curb is a mountable curb allowing emergency or service vehicles to navigate the median safely without the redirecting properties of a vertical or sloping curb such as 2-foot 6-inch curb and gutter.
- 2-foot 9-inch curb and gutter is often used on the low side of a fully superelevated section or along curves of greater lengths. In these cases, hydraulic spread begins to be an issue and the extended gutter width of 2 feet will provide adequate space to contain spread, keeping it further outside of the travel way. If determined by the hydraulics unit that 2-foot 9-inch curb and gutter should be used, obtain a special detail from NCDOT, as there is not currently a standard for it.

### 7.6.2.4 Curb and Gutter

A 2-foot 6-inch curb and gutter is a sloping curb used in urban and semi-urban environments to address issues such as access control, complex terrain, and limited right of way. The 2-foot 6-inch curb and gutter is used to collect surface runoff from paved streets, parking lots, or other impervious surfaces and convey it to a storm drain system. The 2-foot 6-inch curb and gutter is also used in interchanges at the edge of shoulder on the inside of the curve.

## 7.7 Hydroplaning

Hydroplaning occurs when a vehicle loses traction due to a layer of water that builds up between a vehicle's tires and the roadway, preventing constant contact between the tires and the road surface. This situation may lead to vehicle skidding.

There are mitigating strategies to reduce the potential for hydroplaning. These strategies need to be coordinated with the NCDOT Hydraulics Unit and involve an iterative and ongoing collaboration. Some strategies may also require coordination with the Division, and Pavement Design, and Materials and Tests Units.

The NCDOT Hydraulic Design Unit is currently developing hydroplaning guidance specific to North Carolina roadways. Portions of the guidance will be included in the RDM when they become available.

Refer to [NCDOT Guidelines for Drainage Studies](#) for information on the current hydroplaning assessment. Refer to GB Chapter 3 Section 3.3.2.1 and Chapter 4 Section 4.2.4 for additional detailed information.

## 7.8 Paved Ditches

When paved ditches are necessary, they will be included in the drainage recommendations made by the Hydraulics Unit. Discuss the need for paved ditches during the field inspection.

Refer to [NCDOT Roadway Standard Drawings](#) Std. No. 850.01 and section 7.9 below.

## 7.9 Rip Rap for Drainage Ditches

Rip rap for drainage ditches is normally proposed by the Hydraulics Unit where significant water flows are anticipated. Rip rap used to line ditches is typically either Class A, Class B or Class I. Class II rip rap is typically reserved for usage along stream channels.

### 7.9.1 Class A Rip Rap

Class A rip rap is usually recommended within the clear roadside recovery area and is measured by the ton. See Roadway Standard Drawings, Std. No. 876.03 for typical placement of Class A rip rap.

### 7.9.2 Class B, Class I and Class II Rip Rap

Class B, Class I and Class II rip rap are usually recommended outside the clear roadside recovery area. Class B rip rap will be measured by the ton. Measurement in the form of square yards by means of a special provision is permitted if requested by the Division. See Roadway Standard Drawings, Std. No. 876.04 for typical placement of Class B rip rap. See Roadway Standard Drawings, Std. No. 876.01 for typical placement of Class I and Class II rip rap.

## 7.10 Rip Rap at Pipe Outlets

Place rip rap at pipe outlets as recommended by the Hydraulics Unit. Rip rap will be measured by the ton. Measurement in the form of square yards by means of a special provision is permitted if requested by the Division.

Refer to [NCDOT Roadway Standard Drawings](#) Std. No. 876.02 for typical placement of rip rap at pipe outlets.

## 7.11 Geotextile Fabric for Drainage Ditches and Pipe Outlets

Use geotextile fabric in conjunction with rip rap Class B, Class I and Class II unless the Hydraulics Unit specifies otherwise.

Refer to [NCDOT Roadway Standard Drawings](#) Std. Nos. 876.01 and 876.04 for placement of geotextile fabric in drainage ditches.

Refer to [NCDOT Roadway Standard Drawings](#) Std. No. 876.02 for placement and quantities of geotextile fabric at outlet pipes.

Do not use geotextile fabric with Class A rip rap unless specifically directed by the Hydraulics Unit.

## 7.12 Special Ditches

The Hydraulics Unit recommends specially designed ditches to accommodate drainage. These ditches are shown on plans, cross sections, and special details. Show the location, description,

and estimated quantity of drainage ditch excavation for all these ditches on the plan sheets or in a summary table.

## 7.13 Berm Ditches

The Hydraulics Unit recommends berm ditches; however, it is the responsibility of the roadway designer to check each project and determine if berm ditches should be constructed.

Recommend berm ditches where the cut slopes are 10 feet high or greater and 100 feet or more of natural ground at the top of the cut slopes (measured perpendicular to the roadway) drain towards the project. Verify adequate right of way and easements at berm ditch locations. Show berm ditches on plan, profile, and cross section sheets.

Refer to [NCDOT Roadway Standard Drawings](#) Std. No. 240.01 for berm ditch construction.

Refer to [NCDOT Roadway Standard Drawings](#) Std. No. 850.10 and 850.11 for berm drainage outlets.

This page intentionally left blank.

# Chapter 8 At Grade Intersections

## 8.1 General

An intersection is the area where two or more roadways cross and includes the roadway as well as the roadside components that accommodate traffic movements within the area. Each road that branches out from an intersection is referred to as a leg. A four-leg intersection is the most common type of intersection configuration.

There are four types of roadway crossings: at-grade intersections, grade separations without ramps, grade-separated intersections, and interchanges. Intersections generally have adjacent areas that provide for business and community activities and multiple modes of transportation to share the same travel space. Traffic control devices are placed at intersections that require users to stop or slow down. Therefore, intersections generally have less capacity than other areas of the roadway and are also where most accidents occur.

Intersections should be designed to accommodate all modes of travel including automobiles, pedestrians, bicyclists, trucks, and transit. Include not only the roadway pavement, but elements such as sidewalks, bike lanes, and medians in the design.

This chapter of the RDM focuses primarily on at-grade intersections.

Refer to RDM Part I Chapter 9 for more information on interchanges.

Refer to GB Chapter 9 Section 9.2 for more information on general intersection considerations and characteristics.

## 8.2 Types of Intersections

The types of at-grade intersections are three-leg, four-leg, and multi-leg. These intersections can be further described as unchannelized, flared, and channelized intersections. The type of intersections to be designed is based on topography, right of way constraints, number of intersecting legs, modes of the user, traffic volumes, speeds, type of operation, and type of traffic control. Design criteria and the elements of the intersection can be applied once the type of intersection is established. Balance the design of an intersection to accommodate anticipated modes of transportation while also considering the context and community of the project location. Other intersection types include grade-separated, roundabouts, and alternative designs (reduced conflict intersection, median U-turn, bowtie, quadrant, continuous flow, offset, and continuous green -T- intersection).

Refer to GB Chapter 9 Section 9.3 and [Selecting Optimum Intersection or Interchange Alternatives](#) by Dr. Joseph Hummer (located on the NCDOT Congestion Management website) for more detail on types and examples of intersections.

### 8.2.1 Three-Leg Intersections

Three-leg intersections are often referred to as -T- intersections. The most common type of three-leg intersection is unchannelized with single-lane approaches. Generally, this intersection is used for junctions of minor or local roads and minor roads with major roads. In areas where speeds or turning movements are high, auxiliary lanes, such as left and right turn lanes, may be used to reduce the frequency of crashes and increase traffic operations and capacity.

Channelized three-leg intersections utilize islands to separate turning roadway movements from normal through-lane movements in the intersection. For a channelized right turn movement, the

approach roadway could include a right turn lane with a divisional island to separate the right turning movement from the through travel lane. Left turn lanes can be channelized by providing a traditional left turn lane or by transitioning the through lanes to bypass around the left turn lane. Traffic volume, reduction of crashes, and construction costs are factors used in the determination of installing a left turn lane or a bypass lane.

Refer to GB Chapter 9 Section 9.3.1 for more detail on three-leg intersections.

Refer to Section 8.6 below and GB Chapter 9 Section 9.6.2 for more detail on channelization.

Refer to Section 8.6 below and GB Chapter 9 Section 9.6.3 for more detail on islands.

## 8.2.2 Four-Leg Intersections

The design principles, island placement, auxiliary lanes, and other aspects of three-leg intersections can be applied to four-leg intersections. Unchannelized four-leg intersections can be plain or flared and marked with left and right turn lanes. Flared intersections require more pavement and right of way but provide additional capacity for the through and turning movements at the intersection. Channelized four-leg intersections are typically used at major intersections. Channelization for important turning movements such as right turns at intersections can help accommodate large vehicles. Channelized left turns may be utilized at an intersection that carries moderate traffic volumes at high speeds. Auxiliary lanes may be used for storage, speed changes, and maneuvering.

Refer to GB Chapter 9 Section 9.3.2 for more detail on four-leg intersections.

## 8.2.3 Multi-Leg Intersections

Multi-leg intersections have five or more intersection legs and should be avoided if possible. Traffic operations can be improved by reconfiguring the intersection so that some minor roadway movements are removed from the major intersection. A roundabout may be a better solution than reconfiguration of the multi-leg intersection.

Refer to GB Chapter 9 Section 9.3.3 for more detail on multi-leg intersections.

## 8.2.4 Roundabouts

A roundabout is a circular intersection with a central island that traffic travels counterclockwise around. Entering traffic must yield to the traffic already in the roundabout. Design and traffic control elements of a roundabout include yield control, channelized approaches, splitter islands, and curvature within the intersection that allows for speeds less than 30 mph. Roundabouts are classified into three categories based on size and number of lanes:

- Mini-roundabouts
- Single-lane roundabouts
- Multilane roundabouts (including turbo roundabouts)

Roundabouts can be used in rural, suburban, and urban areas. Mini-roundabouts with a smaller inscribed diameter and fully traversable central island are typically used in urban areas due to right of way constraints, slower speeds, and smaller design vehicles such as a school bus. In areas where alignment, visibility, and cross section details are important due to the higher approach speeds, single-lane roundabouts with a larger inscribed diameter and raised central islands are generally used.

~~Refer to RDM Section 8.10 for Roundabout Design.~~



Refer to Section 8.10 and TRB [NCHRP Report 1043 Guide for Roundabouts](#) for more detailed guidance on roundabout design.

Figure 8-1 Typical Single Lane Roundabout

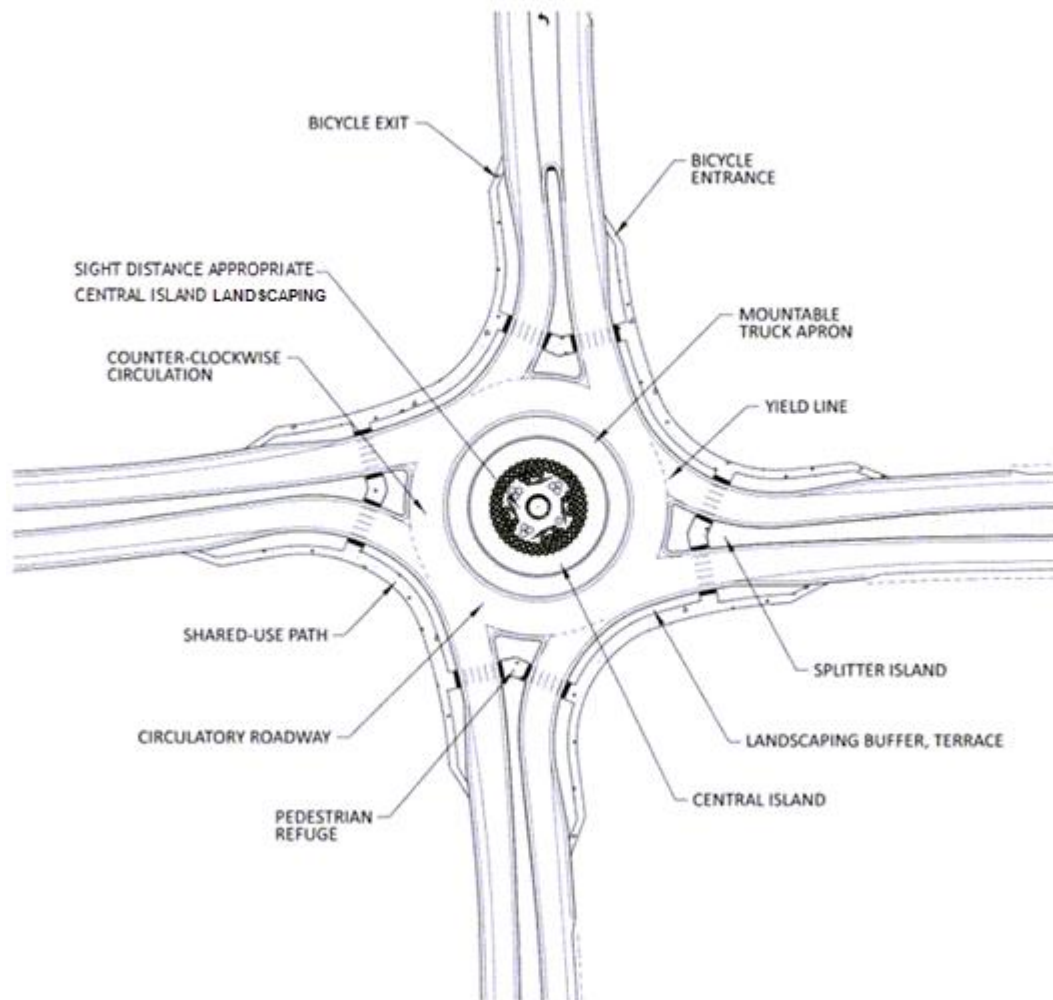

Source: Wisconsin Department of Transportation

## 8.2.5 Reduced Conflict Intersections

Reduced conflict intersections are commonly used on roadways to improve traffic operations and safety by relocating left turns away from intersection and therefore reducing the number of conflict points at the intersection.

Consider using reduced conflict intersections in the following locations:

- Rural median divided facilities
- Roadways with partial or limited control of access
- Intersections with a documented crash history
- In congested areas where it is desirable to minimize the use of traffic signals

The reduced conflict intersection eliminates full-movement median openings. Traffic on the primary highway is not affected, as all movements (thru, left, right) are still permitted. Traffic on

the secondary highway must turn right onto the primary highway. Through and left movements from the secondary highway are directed to a U-turn crossover located downstream (approximately 600–1,000 feet) Refer to Figure 8-2, Figure 8-4, and Figure 8-5 below.

This type of crossover design will be used in various situations. For median divided facilities, full-movement median crossovers have a high crash potential, with the predominate crash-type being the secondary highway far-side angle crash, which has the potential to have the most severe injuries. The directional crossover with U-turns converts the secondary highway left-turn and through movements to two-stage movements, (right turn and U-turn) each of which is significantly safer than the full-movement crossover. Because turning movements are separated the need for signalization at intersections is reduced.

Reduced conflict intersections convert four-leg, multi-phase signalized intersections into up to four two-phase signalized intersections (all points may not require signalization). The reduced number of signalized phases provides for more green time to be allocated to the primary roadway movements, and allows for shorter cycle lengths, which reduce queuing and increase efficiency. Each two-phase signal only impacts one direction of traffic on the primary highway. Because the primary highways' through movements operate independently, signal coordination is simpler and more effective, as the primary roadway has effectively been converted to two parallel one-way streets.

Variations include not permitting the primary highway left turn to turn directly to the secondary highway, diverting that movement to a median U-turn (MUT). This may occur where short weaving and merging distances at the directional crossover may create a safety or capacity problem. For higher volume secondary highways, or for intersections of two primary highways, the MUT variation would permit the through and right movements from each highway to occur at a two-phase signal but direct all left-turn movements to U-turn crossovers. Besides reduced conflict intersections and MUTs, there are many other plausible three-legged and four-legged intersection design concepts that involve the redirection of one or more movements with the goal of more efficient operations and crash reduction.

Refer to [NCDOT Selecting Optimum Intersection or Interchange Alternatives](#) on the NCDOT Congestion Management website or the engineers in NCDOT Congestion Management for more details on alternative intersection design concepts.

Evaluate each intersection on a corridor individually to determine the optimum type of median opening. On current transportation improvement program (TIP) projects, thoroughly discuss the locations where directional crossovers with MUTs are proposed during the public hearing map review and presented at the public hearing. Discuss details of the design features during the Field Inspection. Submit potential retrofit locations for review by the Division Traffic Engineer and by the Traffic Management Unit staff.

Refer to Section 8.8 below for more guidance on Median Openings.

Figure 8-2 Reduced Conflict Intersection

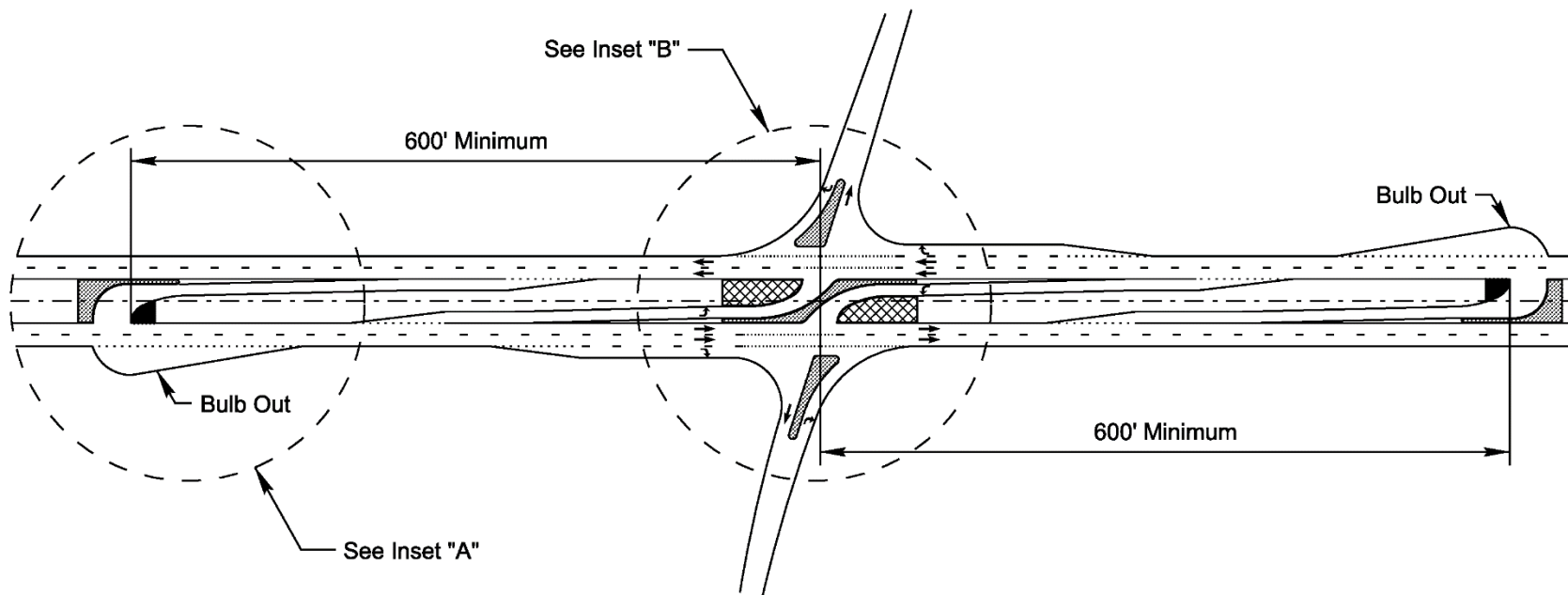

## Notes:

1. This figure shows a generic version of a reduced conflict intersection. Most dimensions will vary based on multiple factors including, but not limited to median width, lane width, design speed and horizontal alignment. Use engineering judgement to establish appropriate geometry.
2. Design U-turns at the intersecting roadway for passenger vehicles unless project information dictates otherwise.
3. U-turns at the bulb outs should be designed for appropriate design vehicle.
4. Coordinate with NCDOT to determine appropriate design vehicle for each bulb out.
5. Obtain full control of access throughout limits of the bulb out on both sides of the roadway.
6. Use 600' minimum length for all left turn lanes (includes taper and full storage length).

Figure 8-3a Reduced Conflict Intersection – Inset “A” Raised Median Section

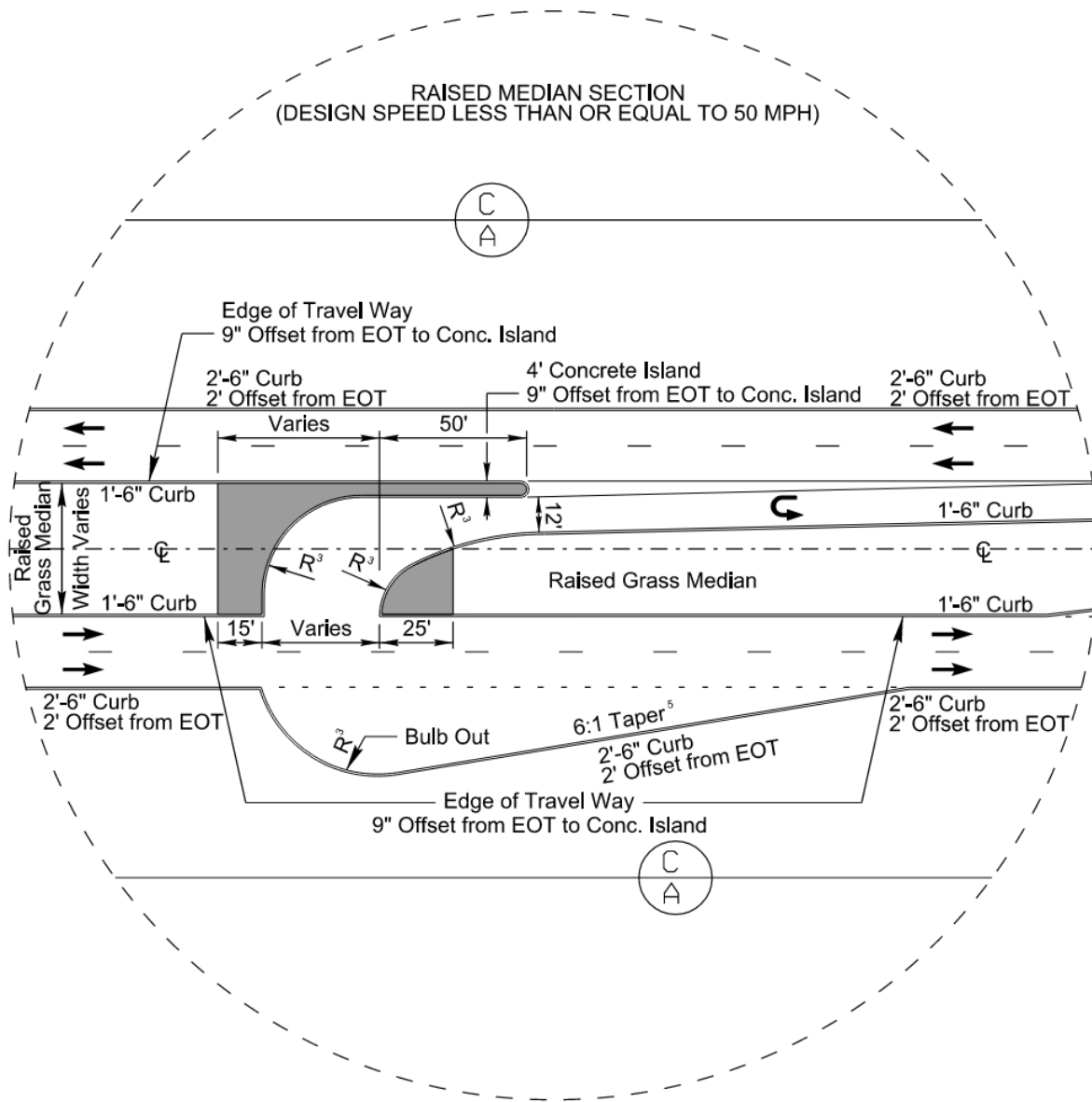
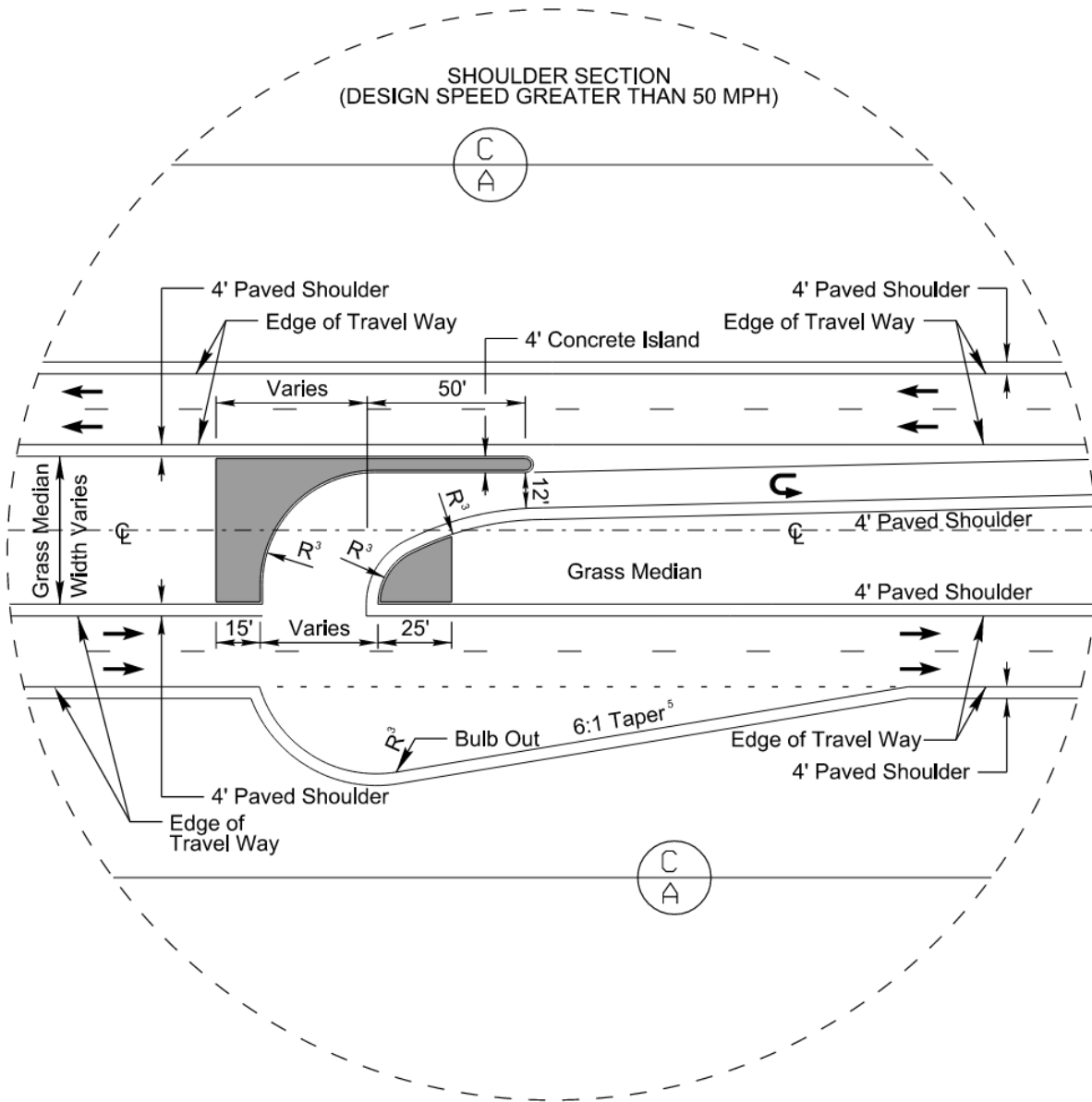

Figure 8-3b Reduced Conflict Intersection – Inset “A” Shoulder Section



Notes:

1. The designer is responsible for determining appropriate geometry based on the appropriate design vehicle and roadway typical.
2. Reverse for opposite end.
3. Radii will vary based on design vehicle and geometric design.
4. Provide a minimum 9" offset from concrete islands to edge of travel ways.
5. Maximum taper length 180'.
6. U-turns at the bulb outs should be designed for appropriate design vehicle.

Figure 8-4 Reduced Conflict Intersection – Inset “B”

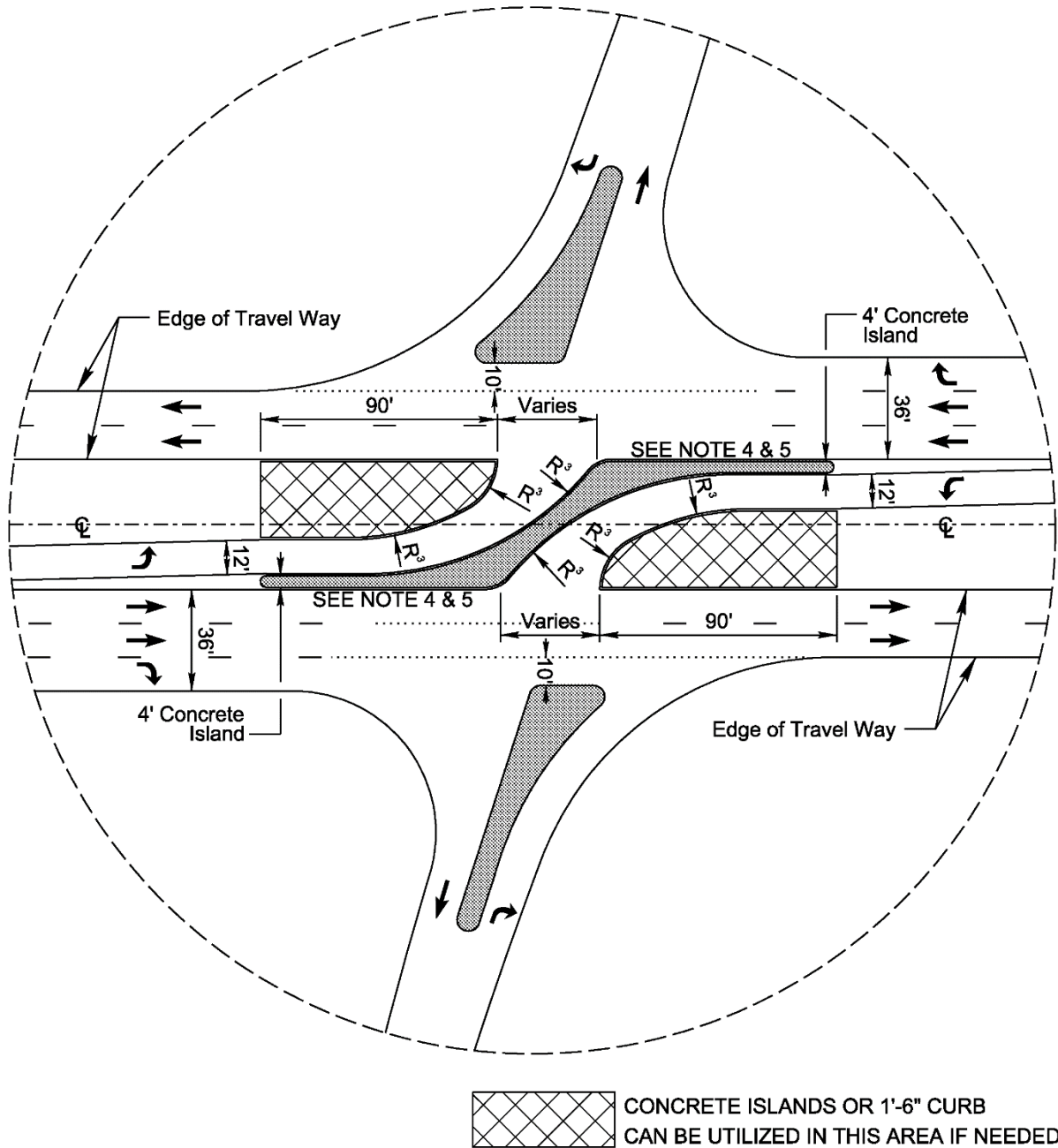

Notes:

1. The designer is responsible for determining appropriate geometry based on the appropriate design vehicle and roadway typical.
2. Design U-Turns at the intersecting roadway for passenger vehicles unless project information dictates otherwise.
3. Radii will vary based on design vehicle and geometric design.
4. Provide a minimum 9" offset from concrete islands to edge of travel ways.
5. Minimum 8' pedestrian walkway width is required within the island.

Refer to GB Chapter 9 Section 9.9 for more detail on directional median crossovers.

## 8.3 Alignment and Profile

Horizontal, vertical alignment, and cross-sectional features affect driver behavior at and on the approach to intersections. Design intersections so users can easily recognize the intersection and vehicles using it and can perform maneuvers to safely pass through the intersection. Keep alignments of the intersecting roadways as straight as possible and the profile as flat as possible to provide maximum sight distance.

Design roads at intersections to meet at or near right angles. Acute-angle intersections require large turning radii and limit visibility. They also increase the amount of time a vehicle needs to cross the main traffic flow. For new construction, design roads to intersect between 75 and 90 degrees, typically. Consider an intersection upgrade if the roads of an existing intersection intersect at less than 75 degrees. For intersections with a severe skew, 75 degrees or less, obtain review and approval of the design by the Division or Roadway Design lead. Documentation providing justification for the design and approval is required.

Refer to Figure 8-5 below for desirable intersection skews.

**Figure 8-5 Desirable Intersection Skews**

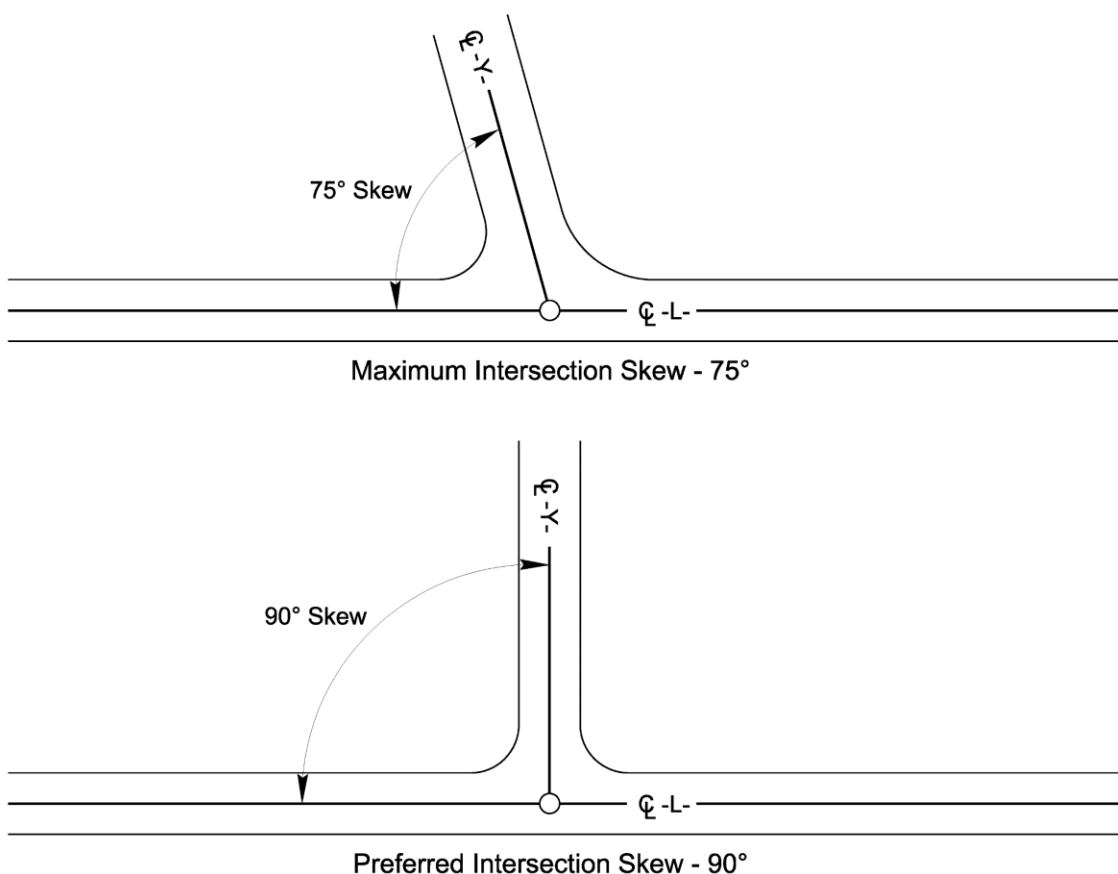

The profile of roadways at an intersection should provide a smooth junction and adequate drainage. Avoid grades that make vehicle control difficult. When designing the profile of a roadway approaching the intersection, limit the maximum grade through the crosswalk to 2 percent per the ADA guidelines for individuals with disabilities. Consider the potential for future signalization of the intersection. In areas where there is a potential for future widening,

design the profile to tie at the same rate as the pavement cross slope for a minimum of 12 feet to accommodate the future widening.

For three-leg, four-leg, and multi-leg intersections, adjust the profile grade lines and cross sections on the intersection legs for a distance back from the intersection, generally 12 to 20 feet, to provide a smooth transition and proper drainage. For intersections with stop control, the maximum allowable rollover is 5 percent. At signalized intersections, it is desirable to match the existing cross slope to avoid rollover. If this is not practical, the maximum allowable rollover for a signalized intersection is 3 percent. Refer to Figure 8-6 below for profile rollover at intersections.

Avoid sag vertical curves at intersections. Avoid sag curves in curb return profiles at the curb ramp locations to prevent pedestrians having to walk through standing water. Coordinate with the hydraulics engineer when establishing the profile to ensure proper drainage through the intersection.



Figure 8-6 Profile Rollover at Intersections

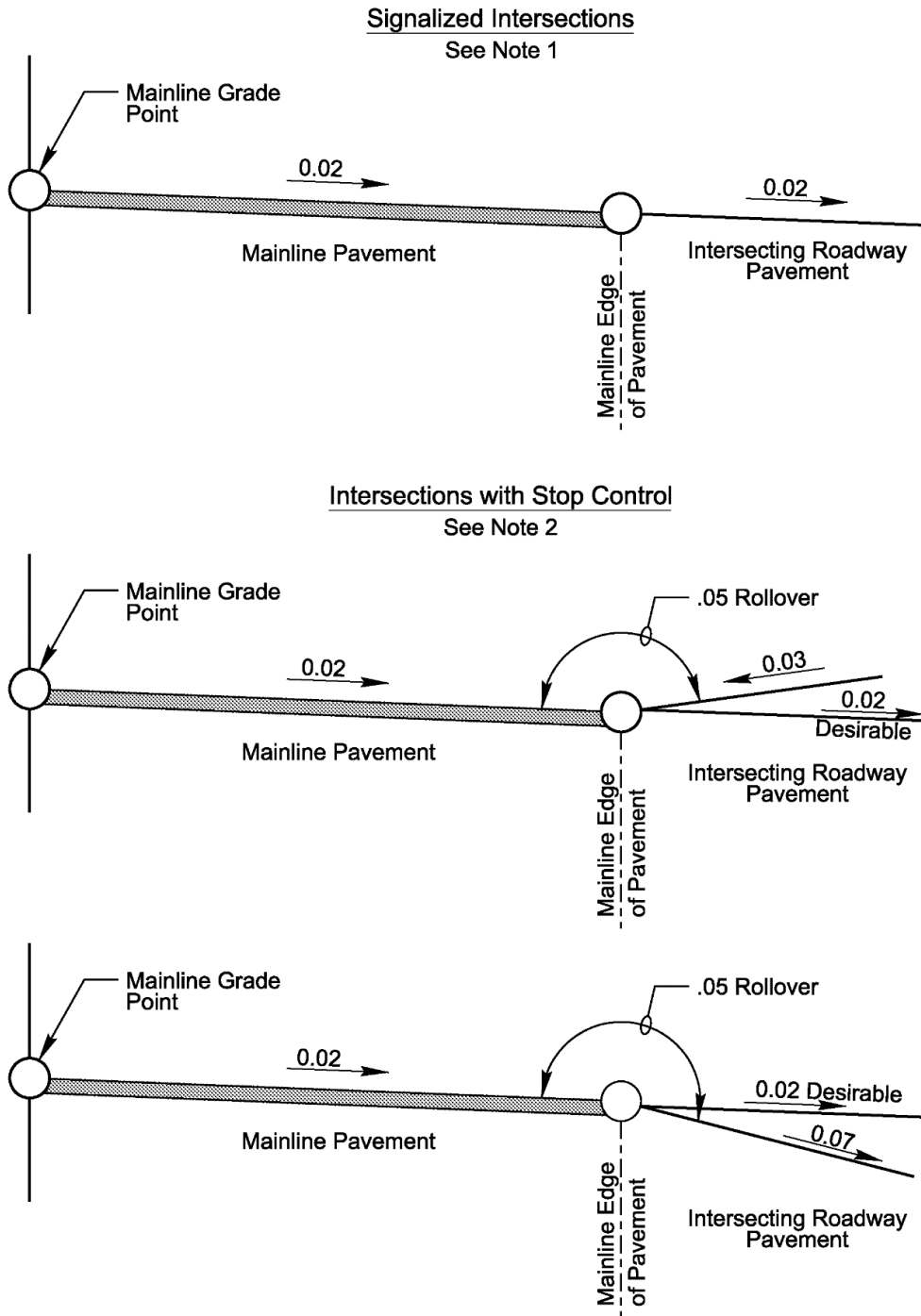

Notes:

1. If possible, avoid any rollover in the profile at signalized intersections. The maximum allowable rollover in the profile is 3%.
2. The maximum allowable rollover in the profile is 5.0% at intersections with stop control.

Refer to GB Chapter 9 Section 9.4 for more detail on alignment and profile of intersections.

## 8.4 Intersection Sight Distance

Different types of vehicular conflicts can occur at an intersection. These conflicts can be reduced if the intersection design provides adequate sight distances and traffic controls. Sight distance at intersections should allow the driver to detect potential conflicts and provide enough time to stop or adjust speed to avoid the conflict. Proper stopping sight distance is necessary on each leg of an intersection for intersection operation.

Provide sight triangles at all intersections, see Figure 8-7 below. Avoid any obstruction in these areas on the approach leg and the corners that may block the driver's view of potential conflicts. The dimensions of the sight triangles are dependent upon the design speed of the roadways and the type of traffic control at the intersection. There are two types of sight triangles: approach sight triangles and departure sight triangle.

Sight triangle dimensions vary depending on the type of traffic control utilized at the intersection.

Refer to GB Chapter 9 Section 9.5.3 for information about the different types of traffic control for determining intersection sight distance:

- Case A – Intersections with no control (GB, Section 9.5.3.1)
- Case B – Intersections with stop control on minor road (GB, Section 9.5.3.2)
  - Case B1 – Left turn from minor road (GB, Section 9.5.3.2.1)
  - Case B2 – Right turn from minor road (GB, Section 9.5.3.2.2)
  - Case B3 – Crossing maneuver from the minor road (GB, Section 9.5.3.2.3)
- Case C – Intersections with yield control on minor road (GB, Section 9.5.3.3)
  - Case C1 – Crossing maneuver from minor road (GB, Section 9.5.3.3.1)
  - Case C2 – Left or right turn from minor road (GB, Section 9.5.3.3.2)
- Case D – Intersections with traffic signal control (GB, Section 9.5.3.4)
- Case E – Intersections with all-way stop control (GB, Section 9.5.3.5)
- Case F – Left turns from major road (GB, Section 9.5.3.6)
- Case G – Roundabouts (GB, Section 9.5.3.7)

Figure 8-7 Intersection Sight Distance

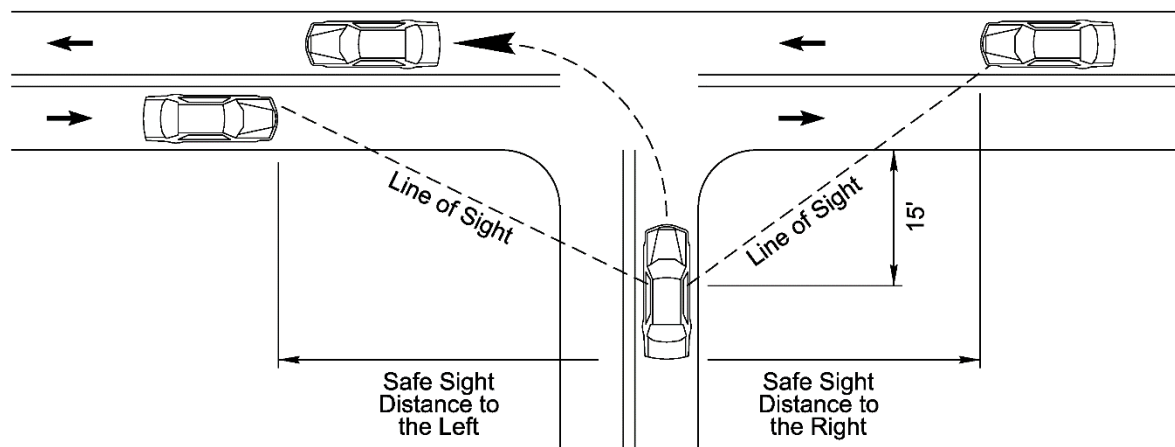

Refer to GB Chapter 9 Section 9.5 for more detail on intersection sight distance.

## 8.5 Design Vehicles

Four general classes of design vehicles have been established: passenger cars, buses, trucks, and recreational vehicles. These selected vehicles are used to establish roadway design controls and are known as design vehicles.

Refer to GB Chapter 2 Section 2.8 for more detail on design vehicles.

- \* The WB-62 is the standard semi-truck WB design vehicle for all routes in the state.
- \*\* For double left turn lanes, design the outside turn lane to meet a WB-62 design vehicle and the inside lane for an SU-30 vehicle.
- \*\*\* At minimum, accommodating a Conventional School Bus (S-BUS 36) should be considered. Coordinate with the local school system to determine if a Large School Bus (S-BUS 40) should be specified in lieu of the S-BUS 36.

\* The North Carolina state law [G.S. 20-115.1](#) allows a tractor-trailer combination with a 53-foot trailer and a maximum 41 feet from center of rear axles to king-pin on all North Carolina primary routes.

The typical WB-62 reflects the maximum axle spacing allowed by North Carolina statute; however, it does not capture the full length of the truck. The typical Florida Department of Transportation design vehicle (WB-62FL) has the same axle spacing and overall 53-foot trailer length dimensions as allowed in North Carolina. While the WB-62 is the standard design vehicle for North Carolina, the WB-62FL can situationally be used as the design vehicle. The WB-67 vehicle exceeds the maximum distance from center of rear axles to king-pin and should not be used as the standard design vehicle.

The dimensions of a WB-62 and WB-62FL are shown in Figure 8-8. WB-62 and WB-62 FL both share the 41-foot distance between the center of rear axles to king-pin. The WB-62FL has a 53-foot trailer and the WB-62 has a 48-foot trailer.

Figure 8-8 WB-62 and WB-62FL Truck Dimensions

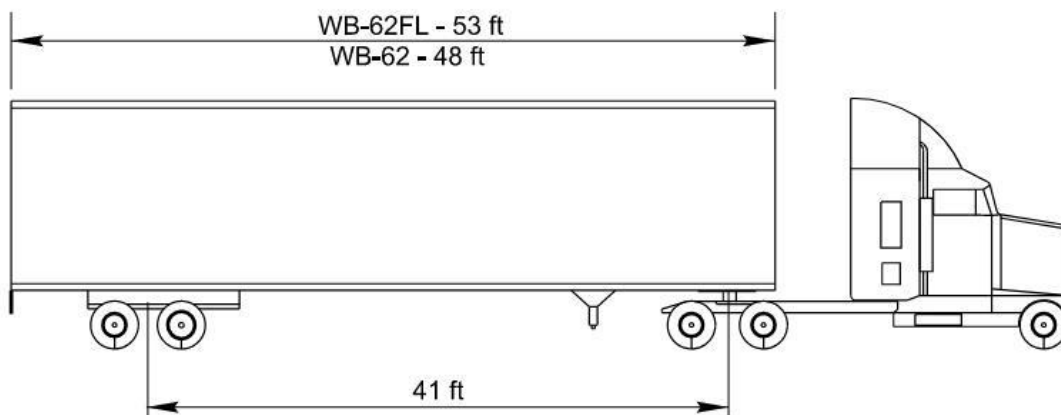

\*\* For multiple left turn lanes, swept path widths are important design factors to ensure vehicles are able to turn side by side without encroaching upon the adjacent turn lane. Determine the estimated paths and direction of the design vehicle and use engineering judgement when designing double and triple left turn lanes. Refer to GB Chapter 9 Section 9.7.3.6 Table 9-27 for swept path widths of specific design vehicles making 90-degree left turns. Under special

circumstances, the standard design vehicle may be larger than a WB-62 when the project is in the vicinity of specialized trucking facilities or is exclusively used for transport of vehicles for motorsport competition events. The distance between the kingpin of the trailer and the rearmost axle, or a point midway between the two rear axles, if the two rear axles are a tandem axle, cannot exceed 46 feet.

\*\*\* In some contexts, such as constrained urban cores or residential areas where large trucks are infrequent and viable alternative routes are available, a smaller design vehicle than the WB-62 may be appropriate. If the standard design vehicle cannot be accommodated, discuss the project specific constraints with the project team and Division and develop documentation of the decision-making process.

## 8.6 Turning Roadways and Channelization

Refer to GB Chapter 9 Section 9.6 for general information on turning roadways and channelization.

### 8.6.1 Turning Roadways

Radii of turning roadways are a function of turning speed, truck considerations, pedestrian crossing distances, and resulting island size. Balance adequate radii for vehicle operation against the needs of pedestrians and the difficulty of acquiring additional right of way or corner setbacks.

Refer to GB Chapter 9 Section 9.6.1.4 Figure 9-21 for an example of how length of crosswalks differs with different curb radii.

#### 8.6.1.1 Simple Curves

Unless very unusual conditions exist, like structures being in the way, provide an absolute minimum radius of 20 feet. Always design the radius length to provide the best traffic operations; therefore, use the minimum only for restricted conditions. Select curve radii based on the appropriate design vehicle to allow the full turning movement where practical. If there is a possibility that the side street will be widened in the near future, provide the proposed section if extensive right of way costs are not encountered.

Refer to GB Chapter 9 Section 9.6.1.4 for additional Information on the selection of the curb radius.

#### 8.6.1.2 Three Centered Curves

Three-centered compound curves can be used at intersections to accommodate truck traffic. Truck movements can be accommodated at intersections with less pavement when three-centered compound curves are constructed. They are especially beneficial in providing truck turning movements at angular intersections. When three-centered compound curves are implemented on a project and the design computations are not in the Design Manual, show the detail on the plans for the benefit of the Resident Engineer in laying out the curves in the field. The radii should be designed to accommodate the design vehicle.

Refer to GB Chapter 3 Section 3.3.7.3 for additional Information on compound curve radii.

#### 8.6.1.3 Widths for Turning Roadways at Intersections

The widths of turning roadways at intersection are governed by the types of vehicles to be accommodated, the radius of curvature, and the expected speed.

Refer to GB Chapter 3 Section 3.3.11 for information on widths for turning roadways at intersections which describes the three different cases, design values, and traffic conditions used in Table 8-1 below. Table 8-1 summarizes the information from GB Chapter 3 Section 3.3.11.2 Tables 3-27 and 3-28.

Table 8-1 Design Widths and Modifications for Edge Conditions of the Traveled Way for Turning Roadways

Radius on Inner Edge of Traveled Way, R (ft)	Traveled Way Width (ft)								
	Case I One-Lane, One-Way Operation— no provision for passing stalled vehicle			Case II One-Lane, One-Way Operation— with provision for passing stalled vehicle			Case III Two-Lane Operation— either one-way or two-way operation		
	Design Traffic Conditions								
	A	B	C	A	B	C	A	B	C
50	18	18	23	20	26	30	31	36	45
75	16	17	20	19	23	27	29	33	38
100	15	16	18	18	22	25	28	31	35
150	14	15	17	18	21	23	26	29	32
200	13	15	16	17	20	22	26	28	30
300	13	15	15	17	20	22	25	28	29
400	13	15	15	17	19	21	25	27	28
500	12	15	15	17	19	21	25	27	28
≥ 600 or tangent	12	14	14	17	18	20	24	26	26
Width Modification for Edge Conditions									
No stabilized shoulder	None			None			None		
Sloping curb	None			None			None		
Vertical curb:									
One side	Add 1 ft			None			Add 1 ft		
Two sides	Add 2 ft			Add 1 ft			Add 2 ft		
Stabilized shoulder, one or both sides	Lane width for conditions B & C on tangent may be reduced to 12 ft where shoulder is 4 ft or wider			Deduct shoulder width(s); minimum traveled way width as under Case I			Deduct 2 ft where shoulder is 4 ft or wider		

## Notes:

A = predominantly P vehicles, but some consideration for SU trucks

B = sufficient SU-30 vehicles to govern design, but some consideration for semitrailer combination

C = sufficient bus and combination-trucks to govern design

Source: GB Chapter 3 Section 3.3.11 Tables 3-27 and 3-28.

## 8.6.2 Channelization

Channelization is the separation or regulation of conflicting traffic movements into definite paths of travel by traffic islands or pavement markings to facilitate the orderly movements of motor vehicles, bicycles, and pedestrians. A simple channelization improvement can sometimes result in dramatic operations efficiencies and reduction in crash frequencies. Avoid using too much channelization because it could create confusion and worsen operations.

Refer to GB Chapter 9 Section 9.6.2 for more information on channelization.

### 8.6.3 Islands

Islands serve three primary functions: (1) channelization – to control and direct traffic movement, usually turning; (2) division – to divide opposing or same-direction traffic streams; and (3) refuge – to provide refuge for pedestrians and traffic control devices. Islands may range from an area delineated by a raised curb to a pavement area marked out by paint or thermoplastic markings.

Refer to GB Chapter 9 Section 9.6.3 for more information on islands.

Design refuge islands at a minimum of 6 feet wide.

Refer to GB Chapter 9 Section 9.6.3.4 and AASHTO *Guide for the Planning, Design, and Operation of Pedestrian Facilities* Chapter 6 for more information on refuge islands.

Provide islands sufficiently large enough to command attention. The smallest curbed corner island normally should have an area of approximately 50 square feet for urban and 75 square feet for intersections in rural areas.

Refer to GB Chapter 9 Section 9.6.3.5 for more information on the design of islands.

Refer to GB Chapter 9 Section 9.6.3.6 Figures 9-24 and 9-25 for information on the design of island approach treatments.

Flush pavement with markings is often more desirable than raised islands especially where posted speeds exceed 45 mph. However, when it has been determined that raised islands will be required (for example for access management), consider both construction and maintenance costs.

In most instances, utilize monolithic construction on islands up to 16 feet in width due to greater cost-effectiveness, ease and speed of placement, and reduced future maintenance requirements. For widths greater than 16 feet, review cost-comparisons between monolithic islands and grass covered islands with curb and gutter to determine the most cost-effective design. In making the determination, consider the projected maintenance cost-savings of the monolithic island and the traffic operation requirements for the particular project.

Full depth pavement is normally utilized under the narrower bulb-type islands and under raised median islands when traffic operations during construction will require vehicular traffic in the median area. When traffic operations are not required in the median, it is more economical to place the monolithic island on a compacted aggregate base.

Refer to [NCDOT Roadway Standard Drawings](#) 852.01 and 852.02 for appropriate application and placement of 5" Monolithic Concrete Islands.

Grassed, landscaped, or covered islands may be used in urban or residential areas where recommended by the Division Engineer and approved by the Roadside Environmental, Construction, and Maintenance Units. These islands provide an aesthetically pleasing appearance with all surroundings, but only when well maintained. The construction costs of grassed or landscaped islands are considerably lower than those of monolithic islands. However, the greatly increased maintenance costs and the increased danger involved in maintenance operations prevents these islands from normally being justified except under unusual circumstances.

Show a special detail in the plans when any type of concrete curb is proposed on a project and it is not in accordance with [NCDOT Roadway Standard Drawings](#), Std. Nos. 846.01, 852.01, and 852.02,. Consult the Plans and Standards Engineer in Project Services prior to drawing any

details. This section has developed several concrete curb configurations that provide satisfactory results.

Refer to RDM Part I Chapter 5 Section 5.3.2.3 for raised island treatment on structures.

### 8.6.4 Superelevation of Turning Roadways at Intersections

For turning roadways with curves that require superelevation, design roadway superelevation and runoff according to GB Chapter 3 Section 3.3.4. At intersections, the outside auxiliary lanes may require a transition from the superelevation cross slope to the cross slope of the intersecting road.

Refer to GB Chapter 9 Section 9.6.4.3 for guidelines for the safe design of the transition between cross slopes.

Refer to GB Chapter 9 Section 9.6.4.3 Table 9-18 for the maximum algebraic difference of the cross slopes at the crossover crown line. This maximum difference is dependent on the speed of the roadway.

### 8.6.5 Stopping Sight Distance at Intersections for Turning Roadways

The values for stopping sight distance as computed in GB Chapter 3 Section 3.2.2 for open highway conditions are applicable to turning roadway intersections of the same design speed.

Refer to GB Chapter 9 Section 9.6.5.1 Table 9-19 for further discussion and a table with the stopping sight distance for turning roadways.

## 8.7 Auxiliary Lanes

An auxiliary lane is defined as the portion of the roadway adjoining the through lanes for speed change, turning, storage for turning, weaving, truck climbing, and other purposes that supplement through-traffic movement.

### 8.7.1 General Design Considerations

In general, auxiliary lanes are used preceding median openings and are also used at intersections to increase capacity and reduce crashes. An auxiliary lane, including the taper area, also serves as a speed-change lane primarily for the acceleration or deceleration of vehicles entering or leaving the through-traffic lanes.

Refer to GB Chapter 9 Section 9.7 for more information on auxiliary lanes.

Left Turn Warrants – In designing an intersection, remove left-turning traffic from the through lanes whenever practical.

Refer to GB Chapter 9 Section 9.7.3 for guidelines for when left turn lanes are cost effective. The following tables and figures are based on a cost-benefit analysis and provide traffic volume-based guidelines, for where unsignalized left turn lanes should be provided:

- GB Table 9-24 and Figure 9-35 for arterials in urban areas
- GB Table 9-25 and Figure 9-36 for two lane highways in rural areas
- GB Table 9-26 and Figure 9-37 for four lane highways in rural areas

Right Turn Warrants – Use Figure 8-9 and Figure 8-10 below to chart and determine the warrants for either a full right turn lane, taper only, or radius only.



Refer to GB Chapter 9 Section 9.7 for more discussion on auxiliary lane warrants.

Refer to GB Chapter 9 Section 9.6.1.2 for guidance on when to use deceleration and acceleration lanes.

For warrants and storage lengths along major routes with signalized intersections, NCDOT requires an operational analysis for signalized intersections and corridors performed by a congestion management engineer.

Refer to TRB *NCHRP Report 707 Guidelines on the Use of Auxiliary Through Lanes at Signalized Intersections* for guidance on auxiliary through lanes that drop beyond signalized intersections.

Figure 8-9 Right Turn Lane Warrants

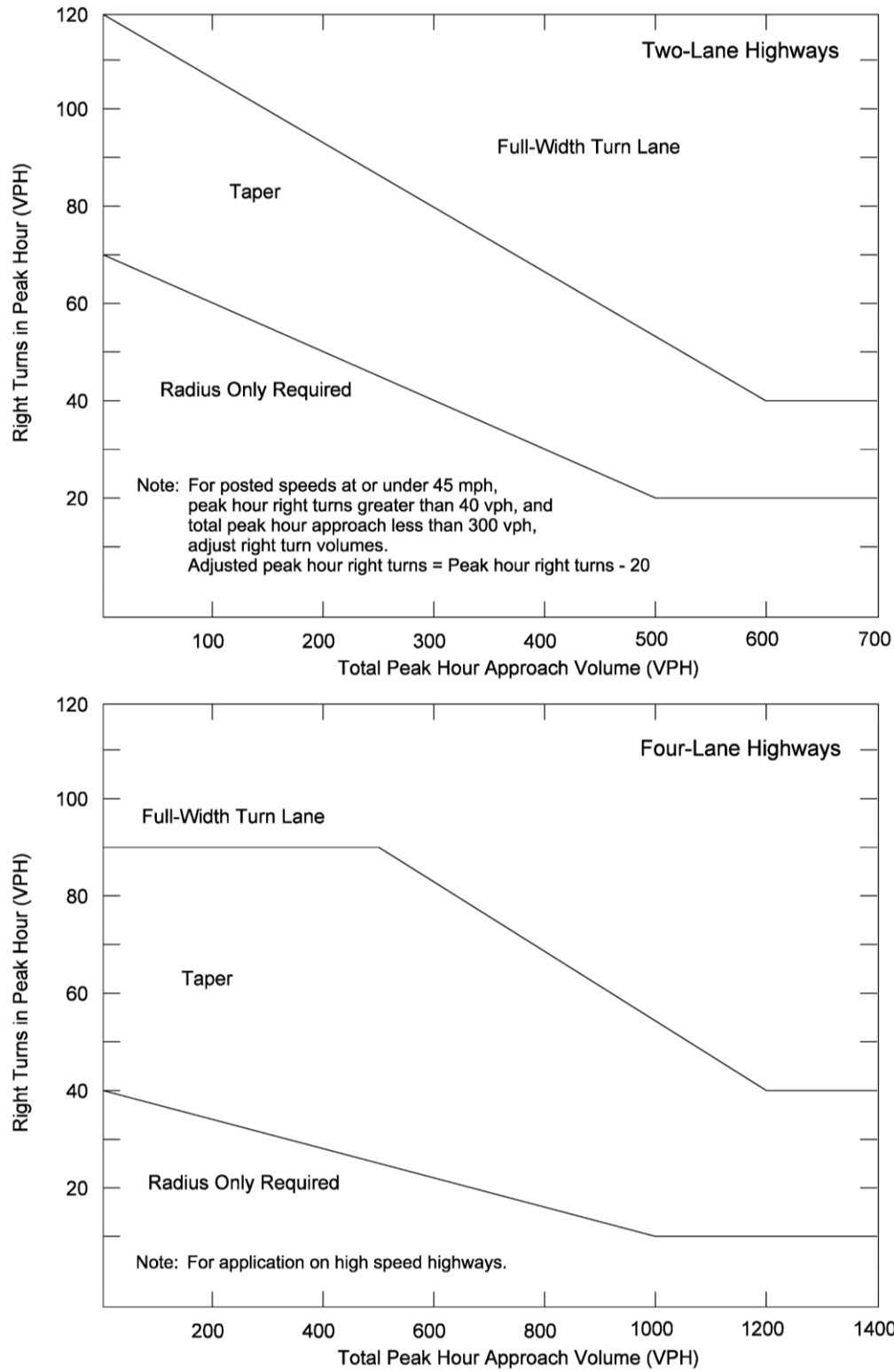

Source: NCHRP 279 Intersection Channelization Design Guide Figure 4-23

Figure 8-10 Turn Lanes

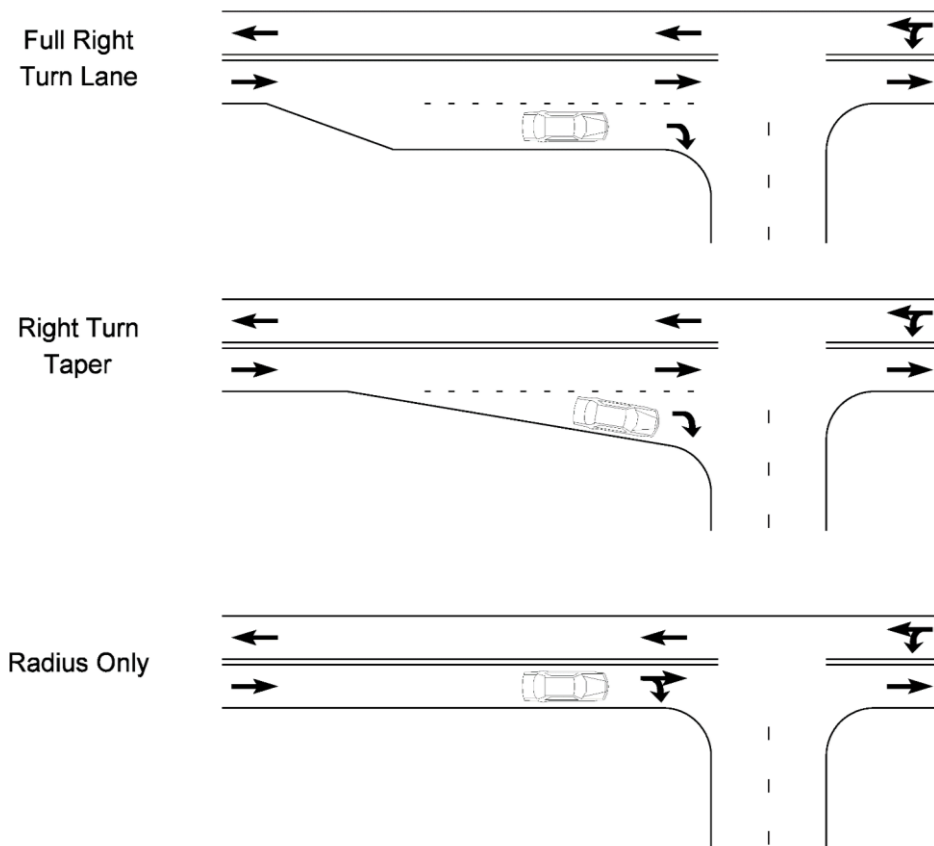

## 8.7.2 Deceleration Lanes

Desirably, the total physical length of the deceleration lane should be the sum of the length for the taper lane change, deceleration, and storage. However, a common practice; however, is to accept a moderate amount of deceleration within the through lanes and to consider the taper length as part of the deceleration length. Refer to GB Chapter 9 Section 9.7.2 for further discussion of deceleration lanes.

### 8.7.2.1 Turn Lane Lengths

Refer to GB Chapter 9 Section 9.7.2.1 Table 9-20 for the desirable values for taper lane change and deceleration distances.

Once the turn lane warrant has been determined, Figure 8-11 below can be used to determine the turn lane length based on the desirable turn lane or taper length-deceleration distance, which includes taper length, and required storage length.

### 8.7.2.2 Storage Length

A deceleration lane should be sufficiently long to store the number of vehicles likely to accumulate in a queue during a critical period. If traffic volume data is not available, design a minimum storage length of at least 50 feet for urban streets with speeds less than 40 mph and at least 100 feet for high-speed or rural locations.

At signalized intersections, the storage length depends on the signal cycle length and signal function, and thus the storage length for signalized turn lanes should be determined by a traffic signal analysis. The operational analysis for signalized intersections and corridors with turning movements, will provide the roadway designer with the recommended variable storage lengths to meet acceptable levels of service.

For unsignalized turning movements, the storage length is dependent on both the volume of turning traffic using the deceleration lane and the volume of opposing traffic.

Refer to GB Chapter 9 Section 9.7.2.2 Tables 9-21, 9-22, and 9-23 for calculated storage lengths to accommodate critical gaps. The 85th percentile Table 9-22 is suggested for design unless field studies can justify the use of the 50th percentile Table 9-21.

### 8.7.2.3 Tapers

Taper rates are commonly based on the speed of the road and normally fall between 8:1 and 15:1 (longitudinal: transverse).

Refer to Figure 8-11 below for acceptable taper lengths for standard roadway applications.

Generally, straight line tapers are particularly applicable where a paved shoulder is striped to delineate the auxiliary lane. For curbed streets in urban areas, a short curve is desirable at each end of long tapers to decrease the probability of vehicles hitting the leading end of the taper.

Refer to GB Chapter 9 Section 9.7.2.3 Figure 9-34a for the different types of taper designs and a full discussion on taper designs.

Figure 8-11 Recommended Treatment for Turn Lanes

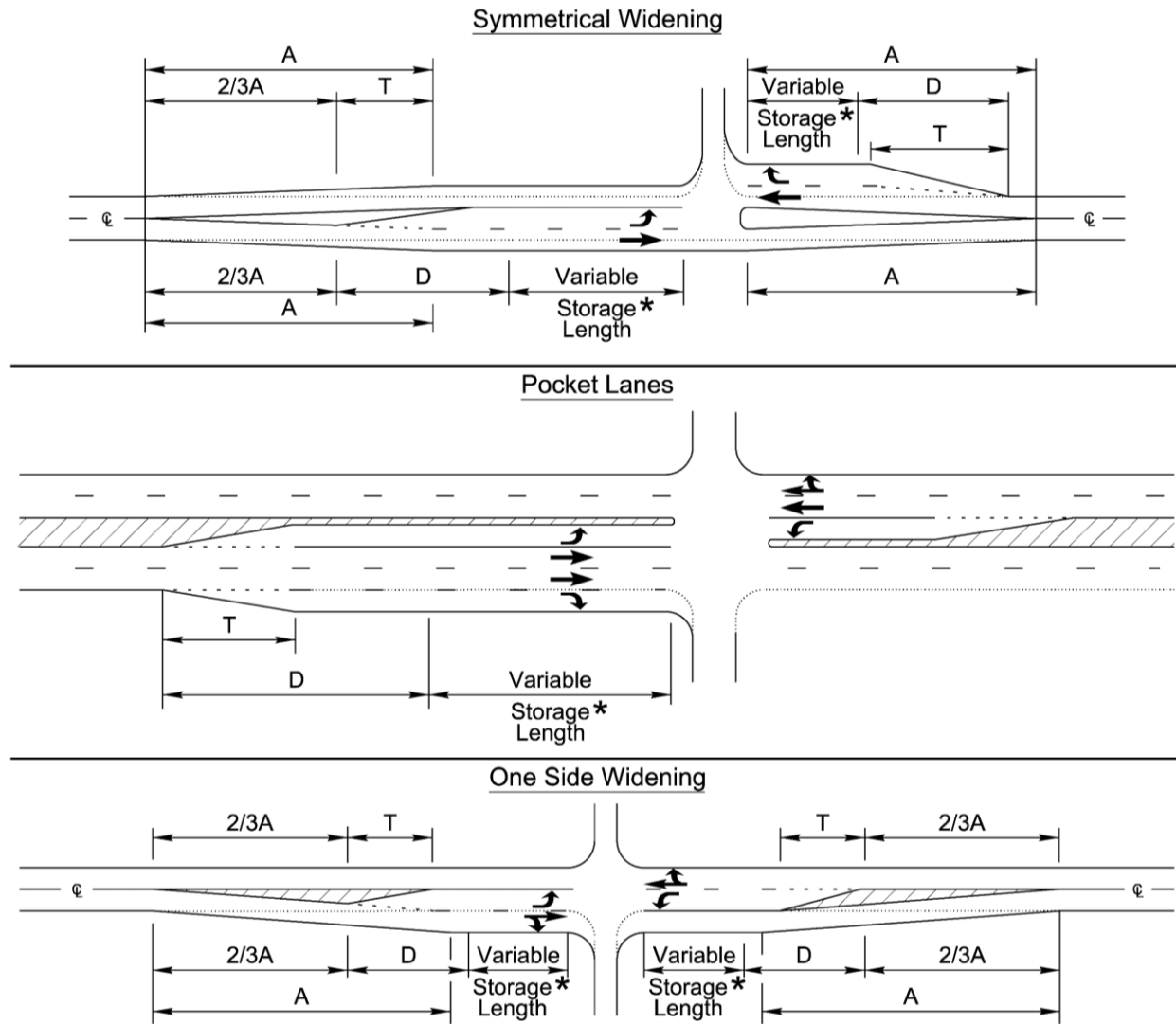

Design Speed (mph)	Posted Speed (mph)	Minimum Deceleration Length (D) <sup>1</sup>	Desirable Lane Change and Deceleration Length (D) <sup>2</sup>	Bay Taper Length (T)	Approach / Departure Taper (A)
					A = WS <sup>2</sup> /60 (if S ≤ 40 mph) A = WS (if S > 40 mph) S = Design Speed W = Width of Lateral Shift
30	<25	100'	150'	75'	* Storage length for waiting vehicles should be calculated based on the latest version of the Highway Capacity Manual or Policy on Street and Driveway Access to North Carolina Highways.
35	30	100'	205'	75'	
40	35	150'	265'	100'	
45	40	150'	340'	100'	
50	45	150'	415'	100'	
55	50	200'	505'	150'	
60	55	250'	600'	200'	

Notes:

- Coordinate with NCDOT and get approval on anything less than the desirable deceleration length. Make every attempt possible to use the desirable deceleration length. It can be shortened as needed but shall not be less than the minimum. Coordinate with NCDOT and get approval on anything less than the desirable deceleration length.
- Refer to GB Chapter 9 Section 9.7.2.1 Table 9-20 for lane change and deceleration lengths for design speeds less than 30 mph and greater than 60 mph.

## 8.7.3 Left Turn Maneuvers

### 8.7.3.1 Median Left Turn Lanes

A median left-turn lane is an auxiliary lane for storage and speed change of left-turning vehicles with a median or divisional island.

When a median left-turn lane uses a curbed median, and the turn lane crosses the crown of the road, care should be taken to provide proper drainage away from the median curb, so water does not pond in the turn lane. [Coordinate with the Hydraulic Engineer to develop the drainage design approach for the turn lane.](#)

Refer to GB Chapter 9 Section 9.7.3.2 Figures 9-38 and 9-39 for median lane designs for various widths of medians.

Refer to GB Chapter 9 Section 9.7.3.2 for further information on design guidelines for median left turn lanes.

### 8.7.3.2 Median End Treatment

Refer to GB Chapter 9 Section 9.7.3.3 for information on the design guidelines for median end treatments.

Refer to GB Chapter 9 Section 9.6.3.6 Figure 9-26 for an example of when to use nose ramping on curbed medians.

### 8.7.3.3 Guidelines for Use of Positive Offset Left Turn Lanes on Median Divided Facilities

Positive offset left turn lanes move the left turn lane closer to the oncoming traffic and leave a gap between the left turn lane and the through lanes going in the same direction. NCDOT prefers the use of positive offset left turn lanes when project conditions allow. The advantages of offsetting the left-turn lanes are as follows:

1. Better visibility of opposing through traffic.
2. Decreased possibility of conflict between opposing left-turn movements within the intersection.
3. More left-turn vehicles served in a given period of time, particularly at a signalized intersection.

Refer to GB Chapter 9 Section 9.7.3.4 Figure 9-40 for an example of a positive offset left turn lane.

Refer to Figures 8-12 through 8-15 below for examples of positive offset left turn lanes for a variety of median widths.

Positive offset left turn lanes are required on median divided facilities where the median width is greater than 20 feet. Design to meet the following criteria.

## Signalized Intersections

Use positive offset left turn lanes at all proposed signalized intersections which meet either of the following criteria:

- Left turns designed with exclusive movements due to inadequate horizontal or vertical alignment with adequate cross section width available
- T intersections with opposing left turn lanes for U-turn traffic

Positive offset left turn lanes enhance exclusive left turn signal operations by reducing the time required for the left turn movements to clear the intersection.

### Unsignalized Intersections

Use positive offset left turn lanes at all unsignalized intersections which meet either of the following criteria:

- Ten-year traffic projections satisfy any signal warrants
- Major route left turns meet or exceed 60 vehicles per hour during the peak hour

### Engineering Judgment

Use positive offset left turn lanes at locations where the engineer determines that their use will improve safety or efficiency of traffic operations.

### Field Inspection

Discuss positive offset left turn lanes on median divided facilities at the Field Inspection.

Figure 8-12 Guidelines for Offsetting Opposing Left Turn Lanes on Divided Roadways with a 23'0" Median

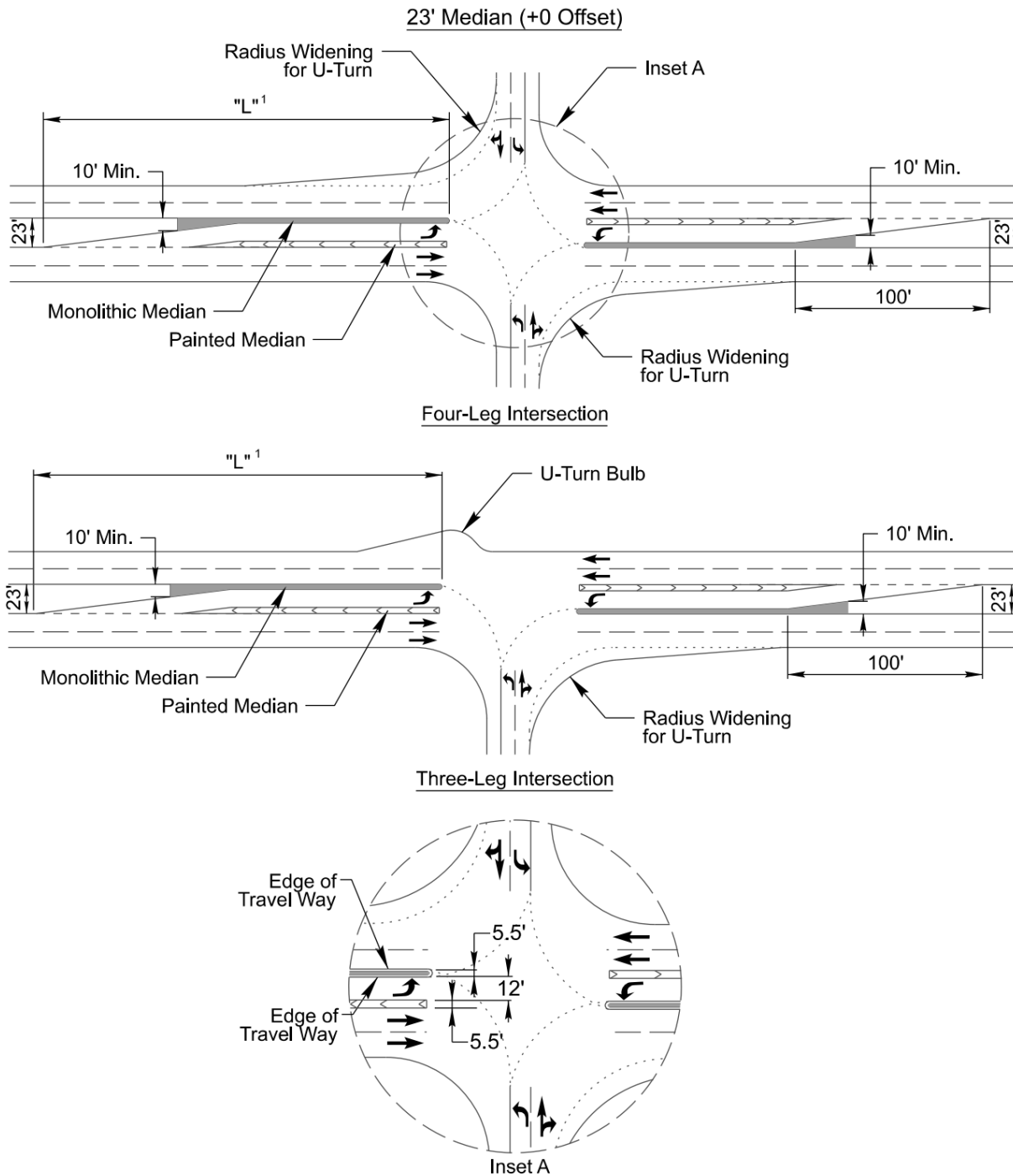

Notes:

1. Provide adequate storage plus deceleration length (L) for the turn lane according to the design speed. A 4 degree skew angle will provide approximately 230' of deceleration length for design speeds up to 35 mph. A parallel deceleration lane can be incorporated for design speeds 40 mph and higher or where additional storage length is required. See Detail B.
2. Design U-turns at the intersection for passenger vehicles unless project information dictates otherwise.
3. Provide a minimum 9" offset from concrete islands to edge of travel ways.
4. Channelization of the side roads is recommended.



Figure 8-13 Guidelines for Offsetting Opposing Left Turn Lanes on Divided Roadways with a 30' Median

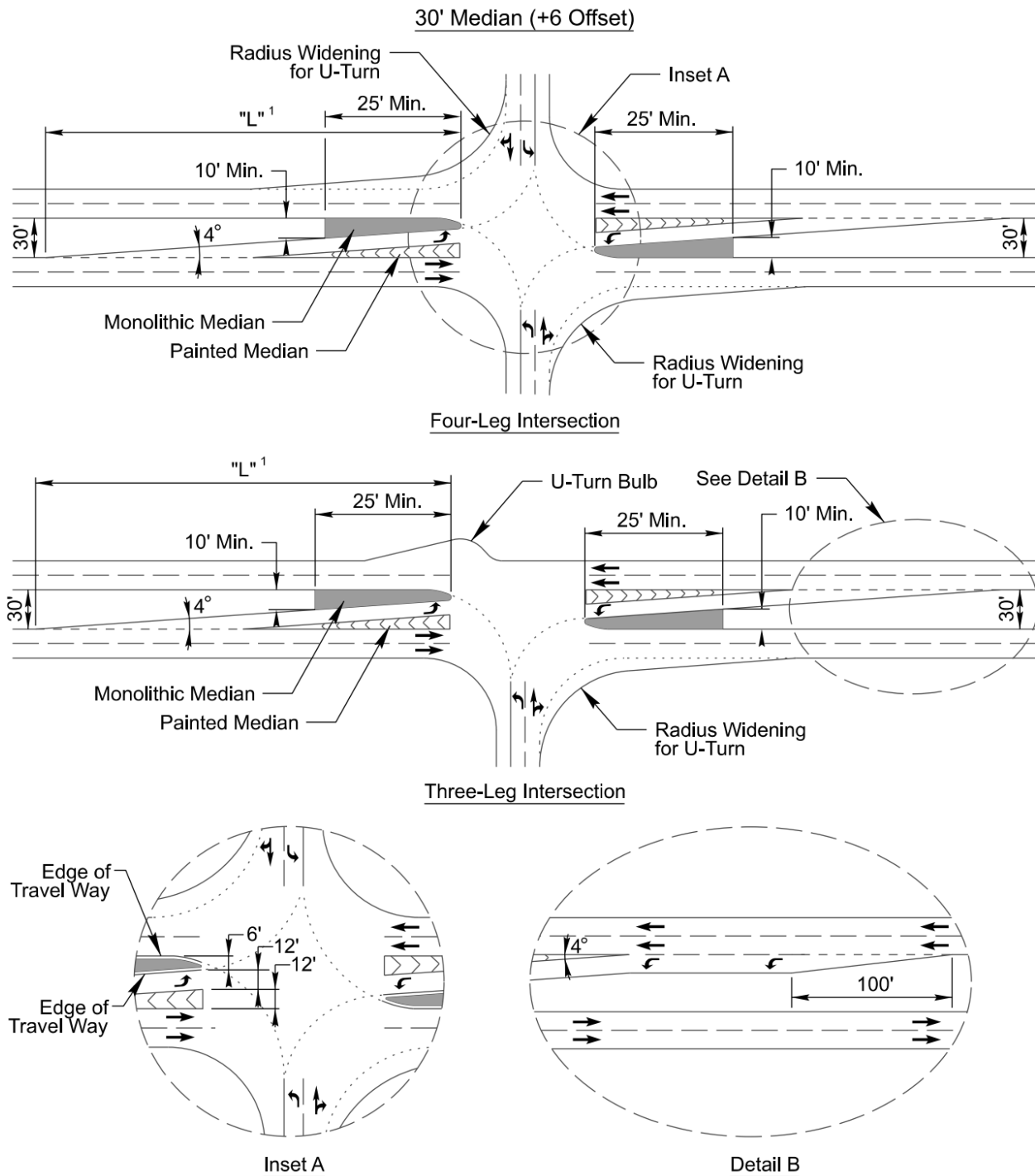

Notes:

1. A 4 degree skew angle will provide approximately 340' of deceleration length for design speeds up to 45 mph. A parallel deceleration lane can be incorporated for design speeds 50 mph and higher or where additional storage [plus deceleration](#) length is required. See Detail B.
2. Design U-turns at the intersection for passenger vehicles unless project information dictates otherwise.
3. Provide a minimum 9' offset from concrete islands to edge of travel ways.
4. [Channelization of the side roads is recommended.](#)

Figure 8-14 Guidelines for Offsetting Opposing Left Turn Lanes on Divided Roadways with a 36' Median

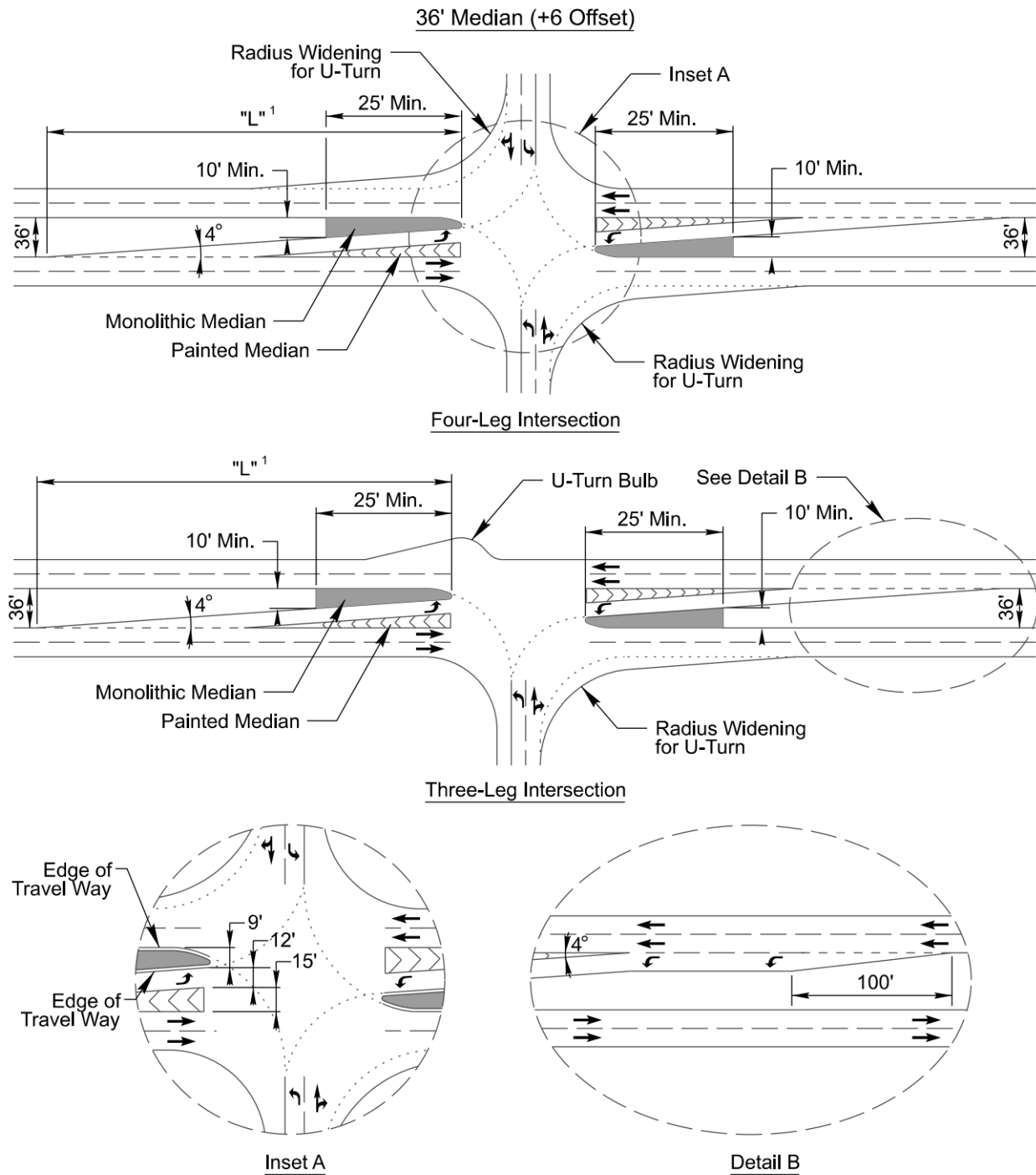

Notes:

1. A 4 degree skew angle will provide approximately 385' of deceleration length for design speeds up to 45 mph. A parallel deceleration lane can be incorporated for design speeds 50 mph and higher or where additional storage [plus deceleration](#) length is required. See Detail B.
2. Design U-turns at the intersection for passenger vehicles unless project information dictates otherwise.
3. Provide a minimum 9' offset from concrete islands to edge of travel ways.
4. [Channelization of the side roads is recommended.](#)

Figure 8-15 Guidelines for Offsetting Opposing Left Turn Lanes on Divided Roadways with a 46' Median

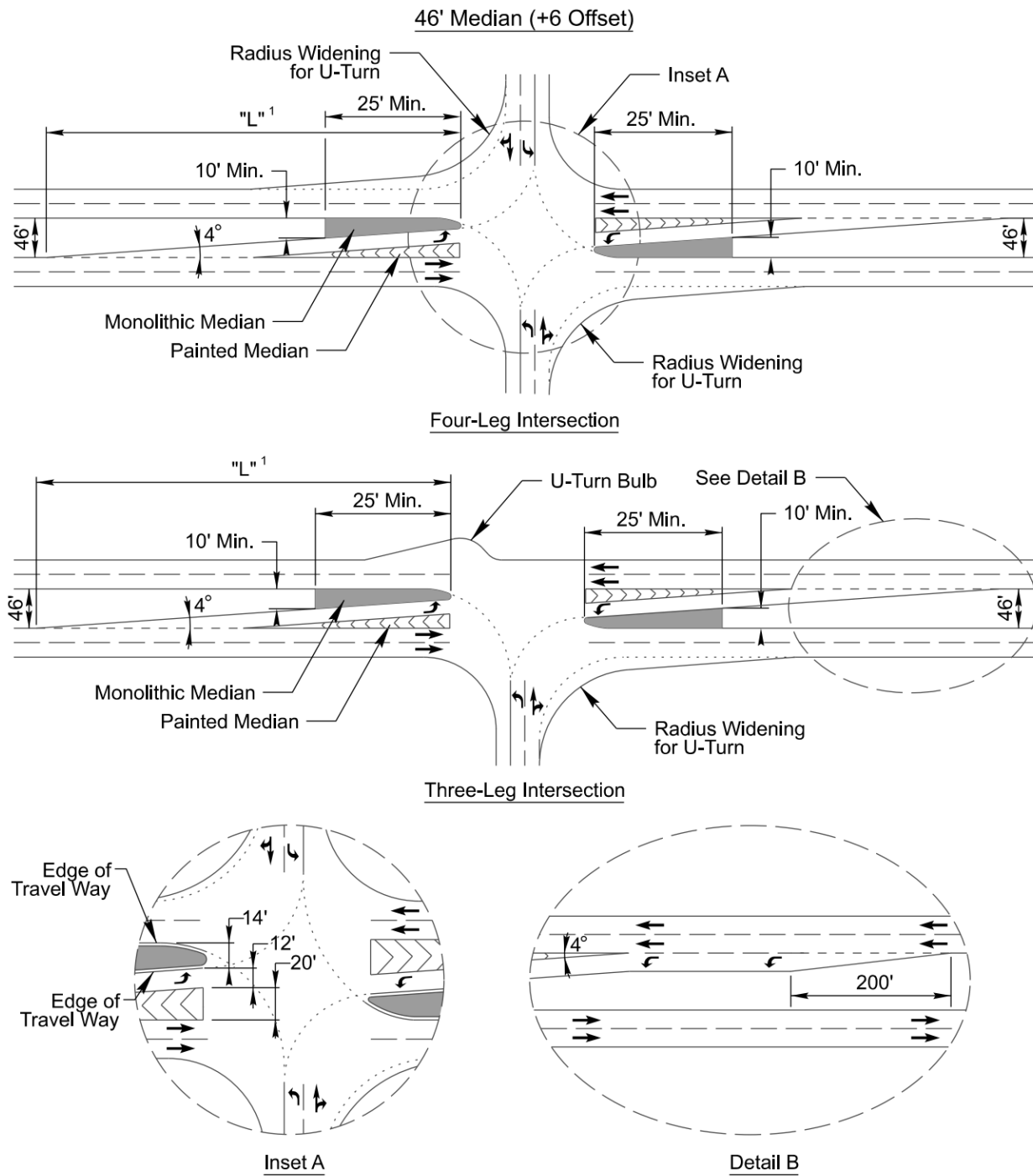

Notes:

1. A 4 degree skew angle will provide approximately 455' of deceleration length for design speeds up to 50 mph. A parallel deceleration lane can be incorporated for design speeds 60 mph and higher or where additional storage [plus deceleration](#) length is required. See Detail B.
2. Design U-turns at the intersection for passenger vehicles unless project information dictates otherwise.
3. Provide a minimum 9" offset from concrete islands to edge of travel ways.
4. [Channelization of the side roads is recommended.](#)

Refer to GB Chapter 9 Section 9.7.3.4 for additional information on the design of offset left-turn lanes.

#### 8.7.3.4 Double or Triple Left-Turn Lanes

Consider double left turn lanes as indicated in the HCM for signalized intersections where left turn volumes exceed 300 vehicles per hour. Off-tracking and swept path width are important factors in designing double and triple left turn lanes. Include adequate width in the receiving leg of the intersection to accommodate two or three lanes of traffic.

Refer to Section 8.5 above and GB Chapter 9 Section 9.7.3.6 for more information on the design of multiple left turn lanes.

#### 8.7.3.5 Two-Way Left-Turn Lanes

In general, use two-way left-turn lanes only in an urban area where operating speeds and traffic volumes (AADT) are relatively low (less than 20,000 vehicles per day) and where there are no more than two through lanes in each direction.

Refer to GB Chapter 9 Section 9.11.7 for more information on the design of two-way left turn lanes.

## 8.8 Median Openings

Refer to RDM Part I Chapter 4 Section 4.9 and GB Chapter 9 Section 9.8 for more information on the design of median openings, including design tables and figures.

## 8.9 Indirect Left Turns and U-Turns

Conventional all-movement intersection designs are sometimes insufficient to address all design objectives at an intersection. Consequently, the engineering community is investigating and implementing innovative, unconventional treatments such as continuous-flow intersections and U-turn median options.

Refer to GB Chapter 9 Section 9.9 for more information about the different types of unconventional intersection designs.

Refer to [NCDOT Mobility and Safety and Mobility website](#) for additional discussion on the benefits of different types of innovative intersections.

## 8.10 Roundabout Design

Roundabouts operate with reduced crash severities by using their geometry to force traffic to enter and circulate at slow speeds. There are multiple types of roundabouts, including mini-roundabouts, single-lane roundabouts, and multi-lane roundabouts. NCDOT Congestion Management has significant involvement in determining where and under what traffic conditions roundabout design is appropriate. Coordinate with the NCDOT Congestion Management Unit to determine if a roundabout is appropriate.

Refer to TRB [NCHRP Report 1043 Guide for Roundabouts](#) for roundabout design guidance including geometric design guidance, an overview of roundabout characteristics, planning, and operational analysis of roundabouts.

Refer to Figure 8-16 below for a typical section of a roundabout with a truck apron.

Figure 8-16 Roundabout Typical Section

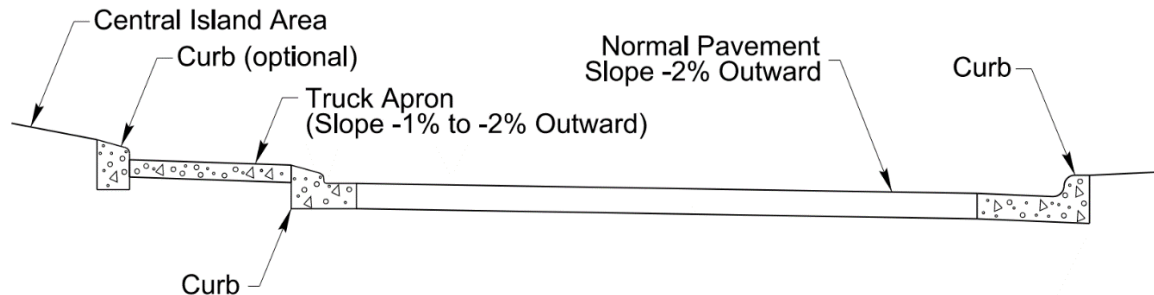

### 8.10.1 Geometric Elements

The geometric elements of a roundabout include the central island, inscribed circle diameter, splitter island, circulatory roadway width, truck apron, yield line, entry radius and width, exit radius and width, pedestrian and bicycle accommodations, and landscaping. It is desirable to have a minimum of 2-feet from the tire track to the curb face.

Refer to TRB [NCHRP Report 1043 Guide for Roundabouts](#) for more information on the geometric elements of roundabouts and a figure showing these elements.

### 8.10.2 Fundamental Design Principles

Designing a roundabout is a process of determining the appropriate balance among operational performance, reduced conflict frequency, and accommodation of the design vehicle.

Refer to TRB [NCHRP Report 1043 Guide for Roundabouts](#) for more information on the fundamental design principles and objectives of a roundabout.

### 8.10.3 Roundabout Drainage

With the circulatory roadway sloping away from the central island, place inlets generally on the outer curb line of the roundabouts. Inlets can usually be avoided on the central island for a roundabout designed on a constant grade through an intersection. In the areas of the splitter islands, keep a normal crown on the approaches and avoid inlets in the splitter islands. As with any intersection, take care to ensure low points and inlets are placed upstream of crosswalks.

If drainage must be piped through the circle, route the pipes outside of the circle, placing junction boxes with manholes outside of the pavement or sidewalk areas. Do not place drainage structures within wheel paths or where they could be easily damaged by heavy traffic.

For roundabouts in open shoulder roadways and with outer truck aprons, the goal is to allow the water to flow along the curb created by the truck apron to a departure lane rather than creating a curb cut through the truck apron.

As with any roadway design, fitting a roundabout design into existing conditions may prove difficult. While keeping the drainage to the outside edges of the roundabout should be the goal, roundabout drainage design exceptions may be approved by NCDOT on a case-by-case basis.

### 8.10.4 Designing for Large Trucks at Roundabouts

A key criterion in the design of any intersection is the choice of a design vehicle, and this is particularly key for roundabouts due to their channelizing geometry. Roundabouts are designed to accommodate trucks.

Refer to RDM Part I Chapter 8 Section 8.5 for additional information about design vehicle standards for North Carolina.

Key considerations related to truck accommodation at roundabouts include the following:

- Inscribed circle diameter (ICD). An inscribed circle diameter (ICD) of 120 to 180 feet is typically needed at single lane roundabouts to accommodate a WB-62 or WB-62FL truck making the right turn movements. A smaller ICD may be possible if the tractor-trailers are only making the through movements. At multilane roundabouts, a common range of ICD is 140 to 180 feet, although smaller ICDs may also be an option for certain design cases.
- Lane widths and curve radii. Design entry and exit lane widths and radii to achieve both truck accommodation and speed control, which may require additional design iterations. Typically, single lane roundabouts designed for large trucks will require entry and exit lane widths of 15 to 20 feet, circulating widths of 16 to 20 feet, entry radii of 60 to 90 feet, and exit radii of 200 to 400 feet or more. At two-lane roundabouts, there are several potential strategies for truck accommodation (see next section) that impact dimensions. Similar ranges of entry and exit radii are commonly found at two-lane roundabouts; however, overall two-lane entry widths commonly vary from 24 ft to 30 feet and circulating widths in the range of 28 to 32 feet. At two-lane roundabouts, additional considerations come into play related to vehicle path alignment to avoid path overlap through the entry and exit. The overall composition of the design becomes more critical than individual dimensions in order to meet performance objectives for speed control, truck accommodation, and vehicle alignment. Also note that as the ICD, entry, and exit widths increase, pedestrians may experience a less comfortable environment due to longer crossing distances and more out-of-direction travel than at smaller roundabouts.
- Truck apron. The truck apron is the traversable portion of the central island that is used for wheel off-tracking by trucks. Typically, the roundabout is designed to allow the front wheels and cab of the truck to remain in the circulatory roadway while the rear wheels and trailer track onto the truck apron. Typically, the truck apron is paved with an aesthetic treatment such as stamped concrete or brick pavers and is distinguished from the sidewalk to discourage pedestrian use. While they may provide more design flexibility in constrained environments, outside truck aprons are discouraged because they tend to accumulate debris and amount to unnecessary construction and maintenance costs.

### 8.10.5 Roundabout Design Resources

Refer to [FHWA Technical Summary Mini-Roundabouts](#) (February 2010) for additional resources concerning the design of mini-roundabouts.

Refer to TRB [NCHRP Report 1043 Guide for Roundabouts](#) for more information on the different types of roundabouts and guidance related to planning for roundabouts.

The curvilinear nature of vehicle paths at a roundabout makes it difficult for pedestrians with vision disabilities who rely on audible cues to navigate these intersections. Refer to TRB [NCHRP Research Report 834 Crossing Solutions at Roundabouts and Channelized Turn Lanes for Pedestrians with Vision Disabilities: A Guidebook](#) for more information about designing roundabouts for pedestrians with vision disabilities.

Refer to [NCDOT Standard Drawing](#) 910.40 for roundabout signing guidelines.

## 8.11 Other Intersection Design Considerations

### 8.11.1 Intersection Design Elements with Frontage Roads

Frontage roads are generally needed adjacent to expressways or freeways where adjacent property owners are not permitted direct access to the major facility. The preferred alternative is to design the intersection with expanded dimensions, particularly the width of the outer separation. This permits the intersections between the crossroad and frontage roads to be well removed from the crossroad intersection with the main lanes.

Refer to GB Chapter 9 Section 9.11.1 for more information on the design of frontage roads at intersections.

### 8.11.2 Bicyclists

When designing intersections, consider and incorporate bicycle facilities including wider roadways to accommodate on-street bike lanes and special lane markings to channelize and separate bicycles from vehicle turning movements. Bicyclists in shared lanes and conventional bike lanes are more exposed to conflicts with turning drivers at signalized intersections. Continue the bike lane to the right of the through lane and consider use of green pavement within bike lanes in conflict zones to delineate bicycle path of travel and reinforce bicycle priority. Keep mixing and weaving zones between bicycles and vehicles as short as possible. Consider using other pavement markings, such as bike boxes, to increase bicyclist visibility with turning vehicles. Where separated bicycle lanes are approaching the intersection, consider elements of protected intersections such as the bend out, a corner safety island, pedestrian island, and bicycle signal operations.

[NCDOT Complete Streets Policy](#) requires designers to consider and incorporate multimodal facilities in the design and improvement of all appropriate transportation projects.

Refer to RDM Part I Chapter 2 Section 2.6 and Chapter 4 Section 4.15 for additional information and resources for the design of bicycle facilities.

Refer to the following for more information on the design of bicycle facilities at intersections.

- *AASHTO Guide for the Development of Bicycle Facilities* (2012)
- [FHWA Separated Bike Lane Planning and Design Guide](#) (2015)
- GB Chapter 9 Section 9.11.
- *NACTO Urban Street Design Guide* (2013)

### 8.11.3 Pedestrians

Pedestrian facilities include sidewalks, crosswalks, traffic control features, and curb ramps. Pedestrian facilities must be designed so that they are accessible to and usable by individuals with disabilities. The [NCDOT Complete Streets Policy](#) requires designers to consider and incorporate multimodal facilities in the design and improvement of all appropriate transportation projects.

Refer to GB Chapter 4 Section 4.17; Chapter 9 Section 9.11.4; and Chapter 2 Section 2.6.5 for more information on the design of pedestrian facilities at intersections.

Refer to *AASHTO Guide for the Planning, Design, and Operation of Pedestrian Facilities* for guidance in providing for pedestrians at intersections.



Refer to [PROWAG](#) for information on designing pedestrian facilities for people with disabilities.

Refer to RDM Part I Chapter 2 Section 2.6 and Chapter 4 Section 4.14 for additional information and resources for the design of pedestrian facilities.

### 8.11.3.1 Lighting

Refer to RDM Part II Chapter 16 for guidance on lighting.

## 8.11.4 Driveways

The design of driveways is similar to that of public intersections. Meet criteria for intersection sight distance as well as other design criteria when designing driveway access.

Refer to RDM Part I Chapter 10 Section 10.4 and GB Chapter 9 Section 9.11.6 for additional guidance on driveway design.

Refer to [NCDOT Policy on Street and Driveway Access to North Carolina Highways](#) for further guidance in providing for driveways.

## 8.12 Railroad – Highway Grade Crossings

### 8.12.1 Horizontal Alignment at Railroad Crossings

#### 8.12.1.1 Track Clearance Requirements on Curb and Gutter Projects Perpendicular to a Railroad

When curb and gutter is being constructed on a project that crosses a railroad, terminate the curb and gutter 13 feet 6 inches from the centerline of the nearest rail of the tracks. For a rounded median island, the distance is measured perpendicular from the centerline of the rail to the face of curb. In switching areas where obstructions would be a hazard to trainmen, more than 13 feet 6 inches may be required. Discuss the termination of the curb and gutter during Field Inspection and with the railroad companies if unusual conditions exist.

#### 8.12.1.2 Track Clearance Requirements on Curb and Gutter Projects Parallel to a Railroad

When it is necessary to construct curb and gutter parallel and in close proximity to a railroad, discuss the location of the curb and gutter in relation to the nearest rail with the Surfaces & Encroachments Manager in the NCDOT Rail Division.

#### 8.12.1.3 Guardrail Treatment at Railroad Signal Crossing

For design speeds less than or equal to 50 mph, do not use longitudinal guardrail, specifically for signal masts, unless the guardrail is otherwise warranted. On projects with design speeds of 55 mph or greater, use guardrail or an attenuator around the signal mast. This requirement applies only to major new construction, reconstruction, or resurfacing, restoration, and rehabilitation projects. This guardrail requirement does not apply to spot safety installations.

Ring type guardrail may be used at locations where there is heavy industrial traffic and where required by the railroad.

#### 8.12.1.4 Rail Grade Separation Guidelines

The grade separation guidelines are based on use of an exposure index which is the product of the number of trains per day and the projected average daily highway traffic at the end of the design period. Unless information to the contrary is available, such as a pending abandonment



of the railroad, assume the number of trains at the end of the design period to be the same as at present.

Construct separations in rural areas when the exposure index is 15,000 or more. Construct separations in urban areas when the exposure index is 30,000 or more.

Where two alignments are under consideration and one would make separation feasible, consider the separation as one factor favoring adoption of such alignment. It is realized that topography, right of way costs, construction costs, or other features of the physical situation may make separation impractical even though the index is above the figure set. In this case, the Secretary of the Department of Transportation shall have final authority in decisions to create new at-grade crossings. Coordinate with the NCDOT Rail Division when a project impacts an existing railroad crossing/grade separation, or a new railroad crossing/grade separation is proposed.

Refer to GB Chapter 9 Section 9.12 for additional information on horizontal alignments at railroad crossings.

### 8.12.2 Vertical Alignment at Railroad Crossings

To prevent drivers of low-clearance vehicles from becoming caught on railroad tracks, the design crossing surface requires the same plane as the top of the rails for a distance of 2 feet outside the rails. As shown in GB Chapter 9 Section 9.12.2 Figure 9-66, the surface of the highway should not be more than 3 inches higher or lower than the top of nearest rail at a point 30 feet from the rail unless track superelevation makes a different level appropriate.

Refer to GB Chapter 9 Section 9.12 for additional information on vertical roadway alignments at railroad crossings.

### 8.12.3 Crossing Design

The geometric design of a railroad-highway grade crossing involves the elements of alignment, profile, sight distance, and cross section. The appropriate design may vary with the type of warning device used.

Refer to the NCDOT Rail Division [Guidelines for Median Separation at Highway-Railway At-Grade Crossing](#) for additional information.

Refer to GB Chapter 9 Section 9.12 for more information on the design of a railroad-highway crossing.

### 8.12.4 Sight Distance at Railroad Crossings

The sight distance at railroad crossings is of utmost importance. When the exposure index does not merit grade separations or railroad signals, use GB Chapter 9 Section 9.12 Equations 9-5 and 9-6, Figures 9-67 and 9-68, and Table 9-29 to provide safe stopping sight distances. If physical barriers exist and it is not economically feasible to provide the required distances, discuss with the project team and NCDOT Rail Division to determine the best solution.

In the referenced figures and tables, Case A and Case B are based on conditions of a 65-foot truck crossing a single set of tracks at 90 degrees. This allows for a margin of safety for conditions using other design vehicles. Consideration may be given to reducing the sight distance if it is determined a small number of trucks will be using the facility.

Refer to the following for additional information:

- GB Chapter 9 Section 9.12.

- [NCDOT Roadway Standard Drawings](#), Std. No. 1205.11 Pavement Markings for Railroad Crossings.
- [FHWA Railroad-Highway Grade Crossing Handbook](#), Report No. FHWA-SA-07-010, August 2007
- [FHWA Railway-Highway Crossings Program](#) website

# Chapter 9 Interchange Design

An interchange is a system of interconnecting roadways in conjunction with one or more grade separations that provides for the movement of traffic between two or more roadways on different levels when at least one of the roadways is a freeway. The meeting of two non-freeways using some type of bridge is called a grade-separated intersection and is not covered in this chapter. Refer to [Selecting Optimum Intersection or Interchange Alternatives](#) (SOIIA), by Joseph E. Hummer, PhD, PE, on the Congestion Management Section website for ways in which these intersections should be treated differently from interchanges.

Refer to GB Chapter 10 before beginning the planning or design of any interchange.

## 9.1 Introduction

The type of interchange configuration best suited for a particular site is influenced by the following factors:

- Number of legs
- Expected volumes of through and turning movements
- Type of truck traffic
- Topography
- Continuity
- Design controls
- Proper signing
- Control of access

Exits along a freeway corridor should have some degree of conformity. Ramps at each interchange should serve all basic directions to minimize potential for wrong-way movements. On a freeway system, interchanges that serve all movements is a basic requirement. Movement through the interchange should be as direct and convenient as practical. Interchanges in urban or partial urban areas should consider accommodation of pedestrians and bicyclists.

Interchange configurations generally fall into two categories – system interchanges and service interchanges. System interchanges describe interchanges that connect two or more freeways and provide for continuous free flow movement. Service interchanges are those that connect a freeway to a facility with a lower classification. These interchanges are typically stop, yield, or signal controlled and do not provide free flow movement on the non-freeway.

In rural areas, interchange configurations are typically selected based on service demand. Interchanges in rural areas can typically be designed on an individual basis without any appreciable effect from other interchanges within the system. Determine interchange configurations by the relative safety history of different ramp terminal configurations, need for route continuity, uniformity of exit patterns, single exits in advance of the separation structure, elimination of weaving on the main facility, signing potential, and availability of right of way.

Selecting an appropriate interchange in an urban environment involves considerable analysis of prevailing conditions so the safest, most efficient, and most practical interchange configuration alternatives can be developed. In urban areas, each interchange may be influenced directly by

the preceding or following interchange to the extent that additional traffic lanes may be needed to satisfy capacity, weaving, and lane balance.

Consider the geometric layout and balance the impacts for each interchange design. Consider the following factors when analyzing whether the interchange is appropriate for the location:

- Relative safety of ramp terminal configurations
- Capacity
- Route continuity
- Uniformity of exit patterns
- Weaving
- Potential for appropriate signing
- Cost
- Availability of right of way
- Construction phasing
- Compatibility with the environment
- Quality of the pedestrian and bicyclist crossing

Work closely with the NCDOT Congestion Management Section to determine the best form to achieve the operational goals and minimize impacts.

Refer to GB Chapter 10 Section 10.9.5 for more information on determining interchange configurations.

## 9.2 Interchange Configurations

### 9.2.1 Three-Leg Designs

A three-leg interchange design is difficult to expand or modify and should typically only be used when a fourth leg is not considered in a future expansion.

Refer to GB Chapter 10 Section 10.9.2 Figures 10-9 through 10-12 for illustrations of three-leg interchange design patterns.

Refer to GB Chapter 10 Section 10.9.2 and SOIIA Three-Legged section for a detailed discussion of three-leg interchanges including advantages, disadvantages, and niche uses.

### 9.2.2 Four-Leg Designs

Interchanges with four intersection legs generally fall under the following general configurations.

#### 9.2.2.1 Ramps in One Quadrant

Interchanges with ramps in only one quadrant have typical application for an intersection of roadways with low traffic volumes where a grade separation is provided due to topography, as part of an initial phase of a staged construction program, where right of way is unavailable in several quadrants, or on a toll facility to limit the number of toll collection facilities. Appropriate locations for this type of interchange are therefore limited.

Refer to GB Chapter 10 Section 10.9.3.1 Figure 10-15 for illustrations of four-leg interchanges with ramps in one quadrant.

Refer to GB Chapter 10 Section 10.9.3.1 and SOIIA Table 8 for a detailed discussion and a listing of advantages, disadvantages, and niche uses.

### 9.2.2.2 Diamond Interchanges

Diamond interchanges are the simplest and most common interchange configuration. Some advantages of diamond interchanges are they allow traffic to enter and exit the major road at relatively high speeds, require very little out of direction travel, need relatively narrow widths of right of way, and treat pedestrians and bicyclists relatively well. Disadvantages include limited capacity and poor signal progression capability. Diamond interchanges with smaller distances between ramp terminals (i.e., tight diamonds) operate quite differently from diamond interchanges with longer distances between ramp terminals (i.e., standard or spread diamonds). Consult interchange operation experts to be sure the type of design matches the desired operation.

Refer to SOIIA for a list of advantages, disadvantages, and niche uses of the different types of diamond interchanges.

Refer to GB Chapter 10 Section 10.9.3.2 Figures 10-17 through 10-19 for illustrations of diamond interchanges.

Refer to GB Chapter 10 Section 10.9.3.2 and SOIIA Table 7 for detailed information including additional advantages, disadvantages, and niche uses.

### 9.2.2.3 Roundabout Interchanges

Roundabout interchanges typically refer to a diamond interchange with roundabouts at the crossroad ramp terminals. The roundabouts can be single lane or multilane.

Refer to GB Chapter 9 Section 9.10 and TRB [NCHRP Report 1043 Guide for Roundabouts](#) for roundabout design and operations.

Refer to GB Chapter 10 Section 10.9.3.3 Figure 10-22 and SOIIA Table 8 for more information including advantages, disadvantages, and niche uses.

### 9.2.2.4 Single Point Diamond Interchanges

The primary features of a single point diamond interchange (SPDI), also commonly referred to as single point urban interchanges (SPUI), are that all four left-turning movements are controlled by a single traffic signal and opposing left turns operate to the left of each other. Typical characteristics of an SPDI are narrow right of way, high construction costs, and greater capacity than typical diamond interchanges. Consideration for potentially complicated structure geometry should be given as early as possible if this type of interchange is being considered.

Refer to GB Chapter 10 Section 10.9.3.4 Figures 10-23 through 10-26 for illustrations of SPDI.

Refer to GB Chapter 10 Section 10.9.3.4 and SOIIA Table 7 for more information including advantages, disadvantages, and niche uses.

### 9.2.2.5 Diverging Diamond Interchanges

The diverging diamond interchange (DDI) uses directional crossover intersections to shift traffic on the cross street to the left-hand side between the ramp terminals within the interchange. This eliminates the need for exclusive left-turn signal phases. DDI design allows for the ramp terminal intersections to operate with simple, two-phase signal operations that provide flexibility to accommodate varying traffic patterns. It also has fewer conflict points when compared to a conventional diamond interchange. Traffic control and bridge staging can be complex. Consider superstructure depth and vertical clearances between roadways and bridges, especially during a retrofit or structure widening. It is good practice to utilize a normal crown typical section through the DDI. Use engineering judgement and document design decisions.

When designing a DDI, it is important to ensure slow, consistent design speeds through the interchange. Tangents should be implemented between reverse curves. It is desirable to have critical sight line angles close to 90 degrees for intersections, with a maximum of 110 degrees in consideration of drivers having difficulty turning their necks.

Refer to RDM Part I Chapter 8 Section 8.5 for information regarding design vehicle selection.

Refer to TRB *NCHRP Research Report 959: Diverging Diamond Interchange Informational Guide* 2nd Edition for additional information.

Refer to GB Chapter 10 Section 10.9.3.5 for detailed information on DDIs and Figure 10-27 for illustrations of DDI layouts.

Refer to SOIIA for a list of advantages, disadvantages, and niche uses.

### 9.2.2.6 Cloverleaf/Partial Cloverleaf Interchanges

Cloverleaves are interchanges that employ loop ramps to accommodate left-turning movements. Interchanges with loops in all four quadrants are referred to as full cloverleaves; all others are referred to as partial cloverleaves or “parclo”. These interchanges are less common in urban areas than in suburban or rural areas with available space.

Refer to GB Chapter 10 Section 10.9.3.6 for examples and detailed discussion of cloverleaf interchanges and Figures 10-28 through 10-32 for illustrations of cloverleaf and parclo interchanges.

Refer to Section 9.3.5 below for information on weaving.

Refer to SOIIA for information on the types of parclo commonly used in North Carolina including advantages, disadvantages, and niche uses.

### 9.2.2.7 Directional Interchanges

Direct or semidirect interchange connections are used for important turning movements to reduce travel distance, increase speed and capacity, eliminate weaving, and avoid the need for out-of-direction travel in driving on a loop. A direct connection is defined as a ramp that does not deviate greatly from the intended direction of travel. Direct connections are generally designed with higher design speeds than other connections.

Refer to GB Chapter 10 Section 10.9.3.7 and Figures 10-33 through 10-39 for more information and examples of directional interchanges.

### 9.2.2.8 Other Interchange Configurations

Refer to GB Chapter 10 Section 10.9.4 and SOIIA for other interchange configurations including:

- Offset interchanges
- Combination interchanges
- Three-level interchanges
- Median U-turn interchanges
- Folded interchanges
- Signalized FRE interchanges
- Synchronized interchanges
- Various System (freeway to freeway) Interchange Designs

## 9.3 General Design Considerations

### 9.3.1 Alignment, Profile, and Cross Section

The design speed, alignment, profile, and cross section in the intersection area, should be consistent with those on the approaching highways. This is not always easily attainable. Maintain a relatively flat alignment and profile of the through highways at the interchange to provide high visibility.

Refer to GB Chapter 10 Section 10.9.5.2.1 for detailed information.

Identify each ramp, loop, and spur in an interchange by a letter designation assigned counterclockwise from the mainline as shown below. For example, ramps or loops may be designated as Ramp A, Loop A, Ramp B, Loop B and so on. All ramp and loop alignments should start at station 10+00.00 and begin at the point of equality station with the mainline (-L-). See Section 12.1 for guidance on plan sheet stationing conventions.

Figure 9-1 Interchange Quadrant Letter Designation

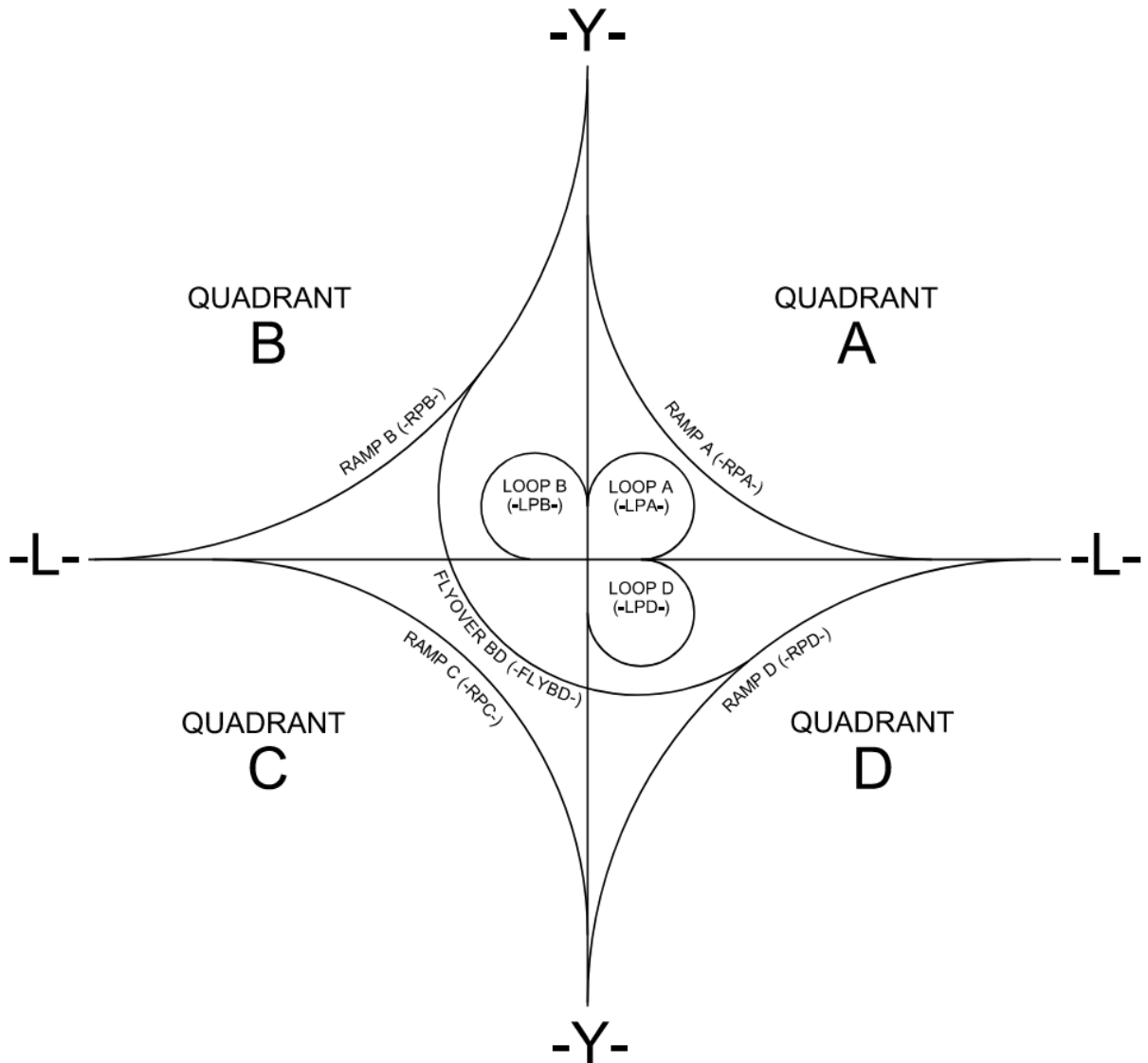

Note: Alignment names shown for illustration purposes only.

### 9.3.2 Sight Distance

Sight distance on the highways through a grade separation should be at least as long as needed for stopping and preferably longer. Where exits are involved, decision sight distance is preferred, although not always practical.

Refer to GB Chapter 10 Section 10.9.5.2.2 for more information.

### 9.3.3 Interchange Spacing

Since both interchange and ramp spacing influence freeway operations, a general rule of thumb for minimum interchange spacing is 1-mile in urban areas and 2 miles in rural areas. In urban



areas, spacings of less than 1-mile may be developed by grade-separated ramps or by adding collector-distributor roads.

Refer to GB Chapter 10 Section 10.9.5.3 Figure 10-47 for an illustration on how interchange spacing is measured.

Refer to GB Chapter 10 Section 10.9.6.3 and Section 9.4 below for more information on ramp spacing.

### 9.3.4 Auxiliary Lanes

An auxiliary lane is defined as the portion of the roadway adjoining the through lanes for speed change, turning, storage for turning, weaving, truck climbing, and other purposes that supplement through-traffic movement. The width of the auxiliary lane should equal the width of the through lane.

Refer to GB Chapter 10 Section 10.9.5.10 for a detailed discussion of auxiliary lanes, as well as examples, and illustrations.

### 9.3.5 Weaving Sections

Weaving sections are highway segments where the pattern of traffic that enters and leaves at contiguous points of access produces vehicle paths that cross each other. These weaving sections may occur within an interchange, between entrance ramps in one interchange and exit ramps in a downstream interchange, or on segments of overlapping roadways. Interchange designs that eliminate or minimize weaving are desirable due to the conflict points that are created. Discuss weaving sections with Congestion Management.

Refer to GB Chapter 10 Section 10.9.5.12 for more information on weaving sections and GB Chapter 2 Section 2.4.6.1 for information on procedures for determining weaving lengths and widths.

### 9.3.6 Collector-Distributor Roads

This section is in reference to collector-distributor roads within an interchange, such as full cloverleaf interchanges. Collector-distributor roads may be one or two lanes in width depending on capacity needs. On the collector-distributor roadway designers should try to maintain a design speed of not less than 10 mph below the design speed of the main roadway. Design outer separation between the mainline and the collector-distributor road as wide as practical, allowing for shoulder widths equal to that on the mainline as well as a suitable barrier to prevent crossing over.

Refer to GB Chapter 10 Section 10.9.5.13 for more information and advantages of collector-distributor roads within interchanges.

Refer to GB Chapter 8 Section 8.4.7.3 for collector-distributor roads between two interchanges and continuous collector-distributors.

### 9.3.7 Control of Access at Interchanges

Provide control of access along all ramps and on -Y- lines at interchanges for a minimum of 1,000 feet beyond the ramp intersections. If for some reason this is not practical, provide full control of access for 350 feet and use a raised island to eliminate left turns for the remaining 650 feet.

### 9.3.8 Pedestrians and Bicyclists at Interchanges

Bicyclists and pedestrians are expected at all intersections and interchange approaches unless not permitted legal access. Design interchange ramps to cross bicycle and pedestrian networks where driver visibility of the crossing is clear (preferably at a 90-degree angle).

Refer to AASHTO *Guide for the Development of Bicycle Facilities*, AASHTO *Guide for the Planning, Design, and Operation of Pedestrian Facilities*, SOIIA, and TRB *NCHRP Research Report 948: Guide for Pedestrian and Bicycle Safety at Alternative and Other Intersections and Interchanges* for more information.

## 9.4 Ramps

One of the primary components of interchanges is ramps. Ramps are roadways that connect a highway facility to one or more highway facilities at an interchange. There are a variety of ramp types and they can be broadly classified as diagonal, loop, directional, semidirect, outer connection and one quadrant. The following information provides details on ramp design and design decisions to consider.

Spiral curves should be used for all ramp and loop alignments on high-speed facilities.

Refer to GB Chapter 10 Section 10.9.6 for more information on ramps.

### 9.4.1 General Ramp Design Considerations

There are different types of ramps and depending on the location and types of facilities, the ramps will have different design features.

#### 9.4.1.1 Ramp Design Speeds

Ramp design speeds should approximate the low volume running speed on the intersecting highways. This design speed is not always practicable and lower design speeds may be necessary. NCDOT preference is to design for the upper range unless there are constraints that prohibit using this range.

**Table 9-1 Guide Values for Ramp Design Speed as Related to Highway Design Speed**

Highway design speed (mph)	30	35	40	45	50	55	60	65	70	75	80
<b>Ramp design speed (mph)</b>											
Upper range (85%)	25	30	35	40	45	50	50	55	60	65	70
Middle range (70%)	20	25	30	30	35	40	45	45	50	55	60
Lower range (50%)	15	20	20	25	25	30	30	30	35	40	45
Corresponding minimum radius (ft)	See GB Chapter 3 Section 3.3.3.3 Table 3-7										

Note: Ramp design speeds above 30 mph are seldom applicable to loops. For highway design speeds of more than 50 mph, the loop design speed should not be less than 25 mph (150-foot radius).

Source: GB Chapter 10 Section 10.9.6.2.2 Table 10-1

A simple rule of thumb commonly used is a 60 mph/40 mph design speed split for exit ramps on a service interchange. This rule is based on a single lane exit ramp from a 70-mph posted facility and applies a 60-mph design speed for the first half of the ramp and a 40-mph design speed for the second half of the ramp.

This rule provides general guidance that allows the designer to reduce the design speed as the exiting vehicle decelerates as it approaches the intersection.

Refer to GB Chapter 10 Section 10.9.6.2 for more information on ramp design speed.

Provide appropriate deceleration and acceleration lanes for all ramps.

Refer to GB Chapter 10 Section 10.9.6.5.2 Tables 10-4 and 10-5 and [NCDOT Roadway Standard Drawings](#) Std. No. 225.03 for information on ramp acceleration and deceleration lanes

### 9.4.1.2 Ramps for Right Turns

GB Chapter 10 Table 10-1 provides a guideline for ramp design speeds in relation to highway design speed. These values apply to the sharpest exit or entrance radius, not the radii at the ramp terminals. When applying the portion of a ramp to which design speed is applicable, the upper range of design speeds is usually achievable for ramps for right turns.

Refer to GB Chapter 10 Section 10.9.6.2.3 and Table 10-1 for more information on ramps for right turns.

### 9.4.1.3 Loop Ramps

Ramp design speeds above 30 mph are seldom applicable to loops. For highway design speeds of more than 50 mph, the loop design speed should not be less than 20 mph. While the GB allows for a 20-mph design speed, NCDOT uses 25 mph with 150-foot radius as the minimum design for loops.

Place a 2'-6" curb and gutter on the inside or right side of traffic on all loops. Design pavement widths to meet the widths for Case II (provision for passing a stalled vehicle) as shown in GB Chapter 3 Section 3.3.11.2 Table 3-27.

### Loop Shoulders

Refer to RDM Part I Chapter 4 Section 4.4.2 for width of ~~usable~~ shoulder on outside of loops.

### Loop Alignments:

- Freeways – 150-foot to 250-foot radii unless conditions warrant otherwise. On interstates, design loops for a 30-mph design speed where feasible. (230-foot radii minimum for 30-mph design speed).
- Expressways – A 150-foot radius is acceptable on highways with a 50-mph or less design speed.
- Two-Lane Loops – 180-foot to 200-foot minimum radii along the inside edge of travel.

Provide appropriate deceleration and acceleration lanes for all loops.

Refer to GB Chapter 10 Section 10.9.6.5.2 Tables 10-4 and 10-5 and [NCDOT Roadway Standard Drawings](#) Std. No. 225.03 for information on ramp acceleration and deceleration lanes.

### 9.4.1.4 Flyover Ramps

Flyover ramps are elevated roadways that connect different traffic streams, bypassing ground-level intersections to significantly reduce congestion and enhance overall traffic flow. Consider two lanes on direct or semi-direct (flyover) ramps to provide passing opportunities.

### Flyover Shoulders

- On flyover ramps it is acceptable to switch the widened offset to the inside of the curve when needed for horizontal sight distance. Widening should not exceed 12 feet. Any width over 12 feet needed to achieve sight distance and avoid a design exception should be coordinated during the design exception evaluation process.

### Flyover Superelevation

- Use .06 super on the .08 max super chart (GB Table 3-10) for directional ramps on fully directional high-speed interchanges where feasible. Use .06 maximum superelevation for the entire curve if there is a proposed bridge on the curve.
- Apply .06 super on the .06 max super chart (GB Table 3-9) as a minimum for designs with limited right of way and semi-direct connections where high-speed designs are not expected. Design with the largest practicable radius while providing .06 maximum superelevation to allow for the highest possible design speed.
  - Coordinate the use of the .06 max super chart to the project team and Roadway Design unit.
  - Document the collaborative design decision to use the .06 max superelevation chart.

#### **9.4.1.49.4.1.5 At-grade Terminals**

Note that ramp design speed can be lowered where the ramp approaches and ties into an at-grade, stop condition intersection.

Refer to GB Chapter 10 Section 10.9.6.2.9 and Section 9.4.3 below for additional at-grade terminal information.

#### **9.4.1.59.4.1.6 Curvature**

Refer to GB Chapter 3 Section 3.3 for guidelines for the design of ramp curves at interchanges. Table 9-2 lists the desirable curvature for ramps with a design speed of 50 mph in the vicinity of the gore area.

**Table 9-2 Desirable Curvature for Ramps in the Vicinity of the Gore Area**

Ramp Type	Desirable Curvature	<u>Desirable Radius</u>
Rural Exit	3 to 5 degrees	<u>1910' to 1146'</u>
Rural Entrance	3 to 5 degrees	<u>1910' to 1146'</u>
Urban Exit	4 to 6 degrees	<u>1432' to 955'</u>
Urban Entrance	3 to 6 degrees	<u>1910' to 955'</u>

Refer to GB Chapter 10 Section 10.9.6.2.10 and [NCDOT Roadway Standard Drawings](#) Std. No. 225.03 for additional ramp curvature information.

#### **9.4.1.69.4.1.7 Sight Distance**

Variables to consider in the evaluation of sight distance design options include grades, horizontal alignment, guardrail, skew, earthwork cost, right of way cost, handrail offset and bridge cost. Another design element of importance is stopping sight distance from ramps that exit the mainline from beneath a bridge. The reduced offset from edge of pavement to piers or

end bent fill slopes may restrict the stopping sight distance in these cases. Design the proper combination of pier location and ramp alignment to provide a minimum stopping sight distance of 350 feet.

Give the same attention to a ramp that exits the mainline immediately after crossing a bridge. Design the proper combination of bridge rail offset and ramp alignment so the bridge railing does not restrict the required stopping sight distance for the ramp. Check these sight lines graphically.

With reduced bridge railing offsets specified in the RDM Part I Chapter 5, horizontal sight distance has become a more critical element of interchange design. Because a narrow bridge can restrict the horizontal sight line, consider a combination of ramp terminal location, the -Y- line grade, and the bridge rail offset to attain the required sight distance across the bridge. Study each interchange design individually to achieve the most cost-effective combination of bridge width, ramp terminal location, and -Y- line grade. Use a 6-foot minimum bridge rail offset on interchange bridges.

Four basic options are available to the roadway designer for providing the required horizontal sight distances:

1. Design the -Y- line grade to enable the driver to see over the bridge rail and guardrail if present. Table 9-3 provides K values for -Y- line grades that will enable the ramp vehicle driver to see over the bridge rail.
2. Increase the bridge rail offset and allow the horizontal sight line to fall inside the handrail. Table 9-3 provides K values for -Y- line grades that will allow a clear sight line inside the bridge handrail.)
3. Use the minimum bridge rail offset required by RDM Part I Chapter 5 and locate the ramp terminal a sufficient distance from the end of the bridge to provide the required sight distance. Table 9-4 shows the distance required from the end of the bridge to ramp terminal to provide the required horizontal sight distance with various bridge rail offset distances. Conversely, Table 9-4 can show the available horizontal sight distance with set ramp terminals and handrail offset distances. Table 9-4 may also be used to derive combinations of handrail offsets and ramp terminal locations that may be necessary in an economic analysis of the interchange layout.)
4. Consider designing grades with the mainline carried over the -Y- line. This design may be cost-effective with a narrow median on the mainline and a multilane -Y- line. Earthwork costs are usually the critical cost elements in this option.

Refer to GB, Chapter 10, Section 10.9.5.2.2 for sight distance information.

#### **9.4.1.79.4.1.8** **Grade and Profile Design**

Use the following list of maximum grades to be used in ramp design:

1. Do not exceed 5 percent for a 50-mph design speed, or 6 percent for a 40-mph design speed, do not exceed 5 percent in areas subject to snow and ice.
2. Limit increasing grades to 4 percent where the ramp is to be used by a high volume of heavy trucks.
3. In exceptional cases, as with loops and urban area ramps, grades may be as steep as 10 percent. However, grades this steep should usually be limited to minor ramps with low volumes. A steep grade on a ramp is not objectionable if the gradient aids acceleration on entrance ramps or deceleration on exit ramps.

4. Use flatter grades for entrance ramps with high design speeds or those joining high-speed highways generally than for ramps with low design speeds or minor, light-volume ramps.
5. Limit grades on ramps with sharp horizontal curvature on downgrades as the high rate of superelevation in conjunction with a steep downgrade makes steering difficult.
6. If a ramp gradient does not aid the acceleration on entrance ramps or deceleration on exit ramps, take care to provide the appropriate ramp length to provide adequate distance for the driver to make the required speed change.
7. Avoid use of sag vertical curves in cut sections when possible.

Refer to GB Chapter 10 Section 10.9.6.2.12 Table 10-2 for more information on maximum ramp grades.

Use the following procedure for establishing ramp grades with control points:

1. GIVEN:
  - a. Mainline alignment, stationing, grade, pavement width, and superelevation.
  - b. Ramp alignment, stationing, pavement width, superelevation, and nose station.
2. FIND: Ramp grade in the area adjacent to the mainline at the exit or entrance point.
3. PROCEDURE:
  - a. Establish a series of control point elevations along the ramp survey line (or grade point) for the ramp grade to pass through in order to provide a smooth, drivable pavement surface at the exit or entrance gore.
    - i. Using a plan sheet with completed horizontal alignment, layout a series of cross section lines at approximately 25' to 50' intervals at pertinent points along the ramp and mainline alignment. A section should be placed at the beginning station and nose station on the ramp. Sections between these points can be placed at random locations in order to adequately cover the pavement. A section should also be placed 200' to 300' beyond the nose station to check the proposed ditch slopes between the ramp and mainline. Refer to Figure 9-2 for an example layout.
    - ii. Using the mainline grade, pavement width, and superelevation, calculate the mainline edge of ~~pavement~~ travel lane elevations adjacent to the ramp at those mainline stations selected with the cross section layout.
    - iii. Establish a maximum, minimum, and desirable elevation at each ramp station selected with the cross section layout. The maximum and minimum range is obtained by applying various superelevation rates on the pavement in the wedge area between the mainline and ramp edges of ~~pavement~~ travel lane. The various rates of superelevation in the wedge area are selected by applying a maximum 0.05 roll-over at the mainline edge of ~~pavement~~ travel lane and then at the ramp edge of pavement adjacent to the wedge area. Refer to Figure 9-3 for an example. It should be noted that the 0.05 roll-over limit is to be used with discretion in each case so that the resultant superelevation does

not create an impractical or awkward section in the wedge area. After selecting a range of superelevation and scaling the width of the wedge area, calculate the maximum and minimum elevation adjustments, due to the wedge superelevation, at each cross section. An additional superelevation adjustment calculation is made for the area from the ramp edge of ~~pavement~~ travel lane to the ramp centerline (4' or 2' width for a single lane ramp). Also, a desirable or ideal elevation adjustment is of value in computing the ramp grade. This is calculated by assigning the ideal or most comfortable superelevation in the wedge area. This desirable elevation adjustment will obviously fall within the maximum and minimum range as described above.

At this point, the maximum, minimum, and desirable elevation adjustments are applied to the mainline edge of ~~pavement~~ travel lane elevations at each set of stations to provide a series of elevations on the ramp centerline thru which the proposed ramp grade must pass. It is helpful to prepare a chart for listing the various stations and their respective superelevation and elevation adjustments in calculating the maximum, minimum and desirable elevations.

Figure 9-2 Ramp Gore Grade Control Points



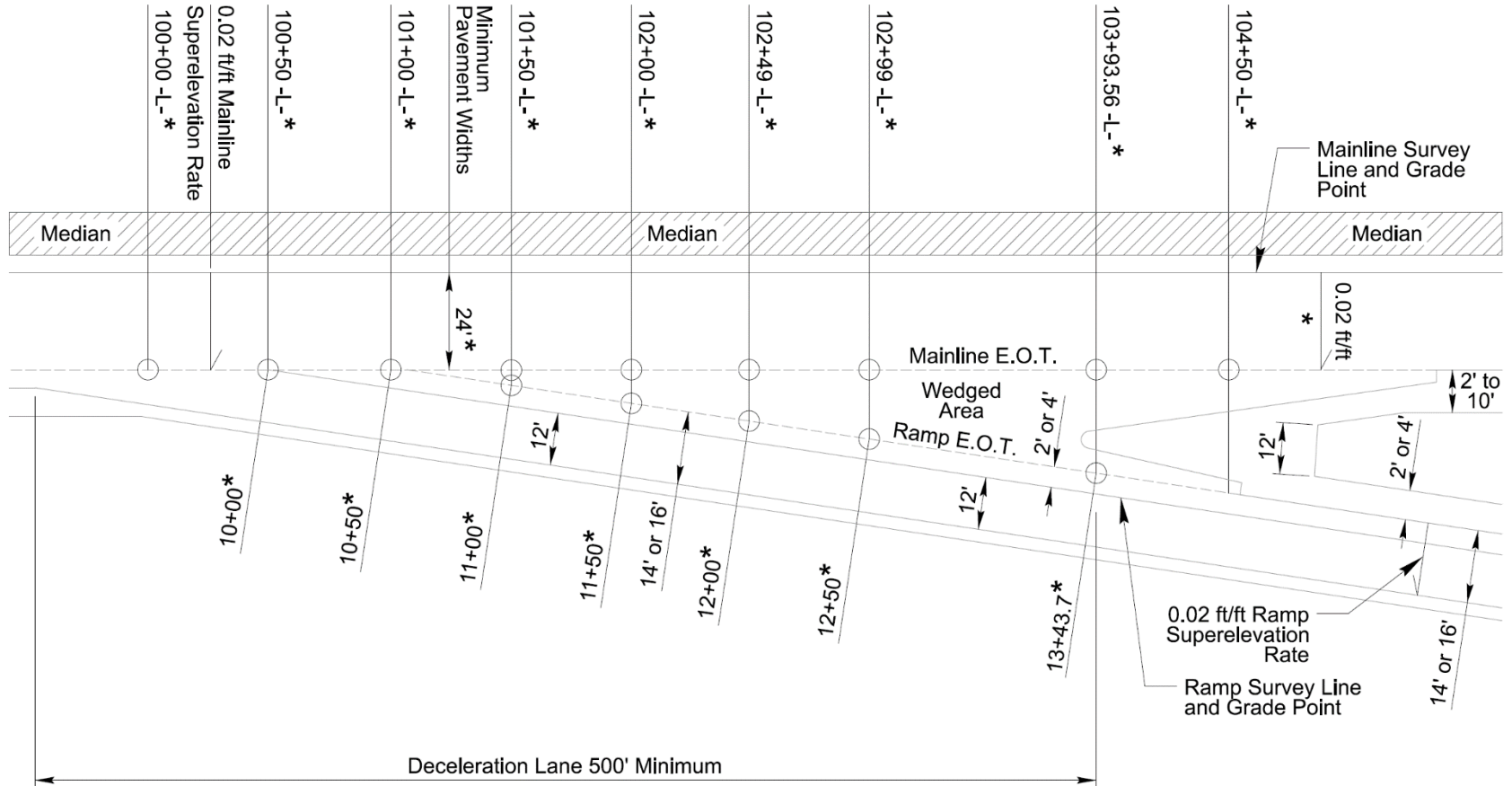

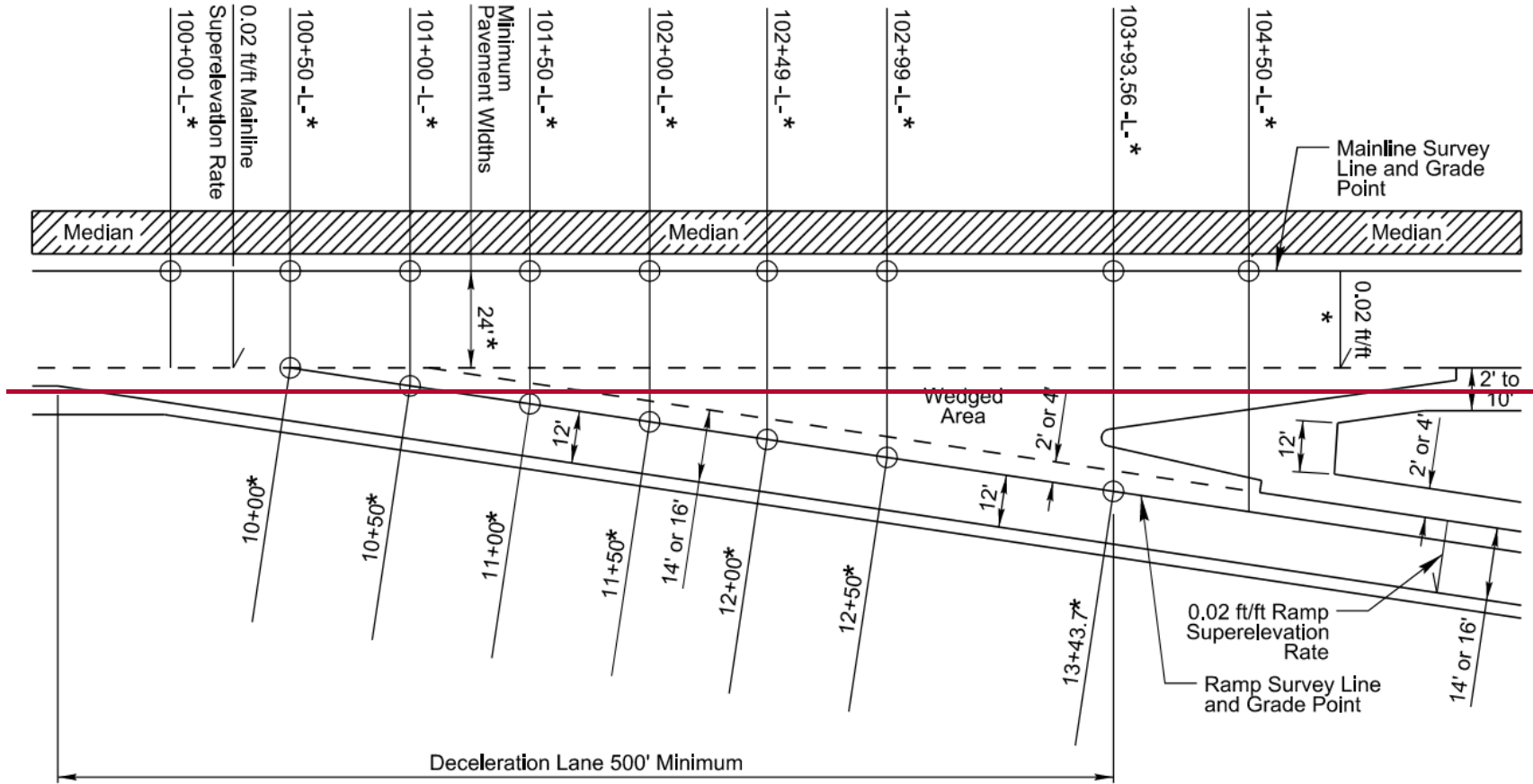

Note: \* Indicates variable dimensions or station. Given dimensions shown are for example computations.

Figure 9-3 Maximum Grade Control Points in Gore Area

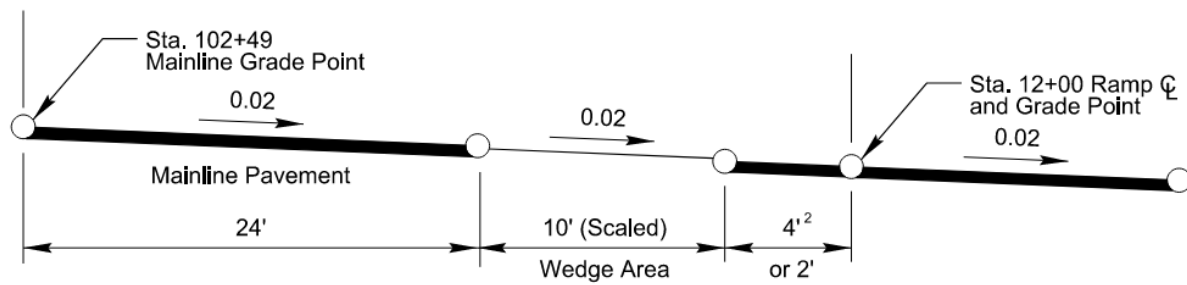
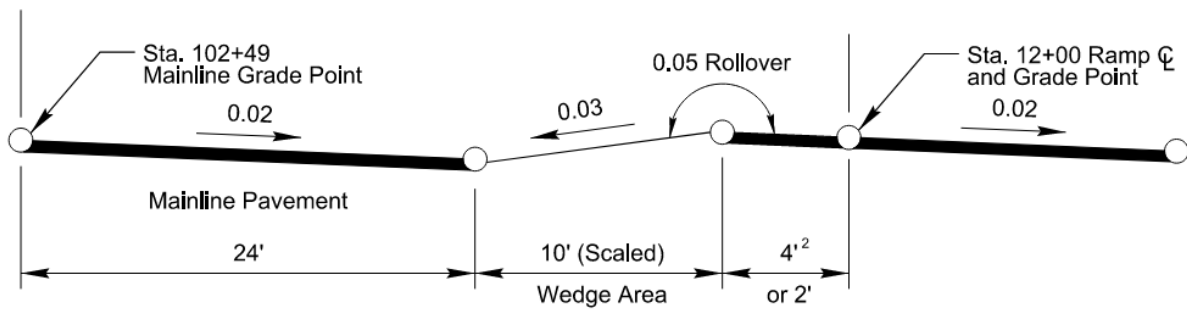
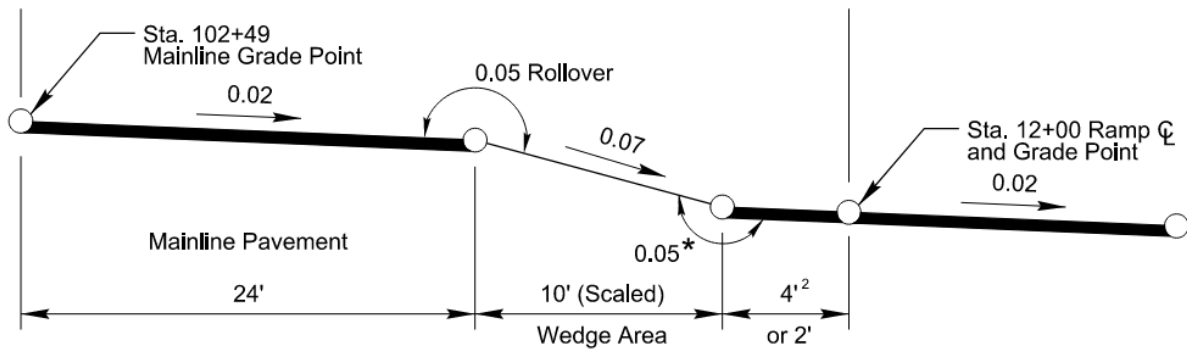

Notes:

1. Station dimensions and superelevation are shown as example situations.
2. 4' or 2' dimension dependent upon ramp pavement width (16' or 14').

Refer to GB Chapter 10 Section 10.9.6.2.12 Table 10-2 for additional guidelines on maximum ramp grades.

Refer to GB Chapter 10 Section 10.9.6.2.12 for additional information on ramp grade and profile.

**9.4.1.89.4.1.9 Vertical Curves**

Refer to GB Chapter 10 Section 10.9.6.2.13 for information on ramp vertical curves.

### **9.4.1.9** **9.4.1.10** **Superelevation and Cross Slope**

Follow guidelines in GB Chapter 10 Section 10.9.6.2.14 for cross slope design on ramps.

### **9.4.1.10** **9.4.1.11** **Gores**

Gores are the areas between the through roadway and the exit or entrance ramps. There are three types of gore areas: taper, parallel, and major fork.

Keep gore areas free of obstacles and traversable to protect errant vehicles.

Refer to [NCDOT Roadway Standard Drawings](#), Std. No. 225.03 for information on gore layout.

Refer to GB Chapter 10 Section 10.9.6.2.15 for additional gore information and Figure 10-64 for examples of gore types.

## **9.4.2 Ramp Traveled Way Widths**

Refer to RDM Part I Chapters 4.2 and 4.3 and GB Chapter 10 Section 10.9.6.3 for information on ramp traveled way widths.

### **9.4.2.1 Width and Cross Section**

Ramp lane width is generally 14 feet. Consider using a lane width of 16 feet where traffic volumes or truck percentages are high. Use a lane width of 16 feet on the interstate system.

Refer to GB Chapter 3 Section 3.3 Table 3-27 for design widths of ramp traveled ways for various conditions.

Refer to GB Chapter 10 Section 10.9.6.3.1 for additional information on ramp width and cross section.

### **9.4.2.2 Shoulder Widths and Lateral Offset**

Refer to RDM Part I Chapter 4.4 for **usable** shoulder width. Paved shoulders are required on both sides of the ramp.

Refer to GB Chapter 10 Section 10.9.6.3.2 for more information on shoulder widths and lateral offset.

### **9.4.2.3 Shoulders and Curbs**

Refer to GB Chapter 10 Section 10.9.6.3.3; RDM Part I Chapter 4; and NCDOT Paved Shoulder Policy for information on shoulders and curbs.

## **9.4.3 Ramp Terminals**

The ramp terminal of an interchange is that part of the ramp next to the through traveled way. Ramp terminals may be designed as an at-grade type, where traffic is controlled with a stop condition, roundabout, or signal at the intersecting roadway; or designed as a free-flow type where traffic merges with the intersecting roadway in a continuous flow.

### **9.4.3.1 Diamond Interchange Terminal Location and Sight Distance**

At crossroads, locate ramp terminals far enough away from the grade separation structure to provide adequate sight distance except in configurations like the tight diamond where this is not possible. Tables 9-3 and 9-4 provide additional information on sight distance on -Y- lines at diamond interchanges.

Table 9-3 Vertical Sight Distance Control for Crest Curves at Interchanges, Single Unit Vehicle Criteria

Crossroad Design Speed	Sight Distance "d" Required for SU Ramp Vehicle, Left Turn Maneuver (See Note 2)	"K" Required for Stopping Sight Distance along Crossroad (See Note 3)	"K" Required to Provide Sight Distance "d" for SU Ramp Vehicle Left Turn Maneuver (See Note 4)	"K" Required to Provide Sight Distance "d" for SU Ramp Vehicle Sighting over Bridge Rail (See Note 5)
70 mph	980'	247*	205	389
60 mph	840'	151*	151*	286
50 mph	700'	84	105*	199
40 mph	560'	44	67	127

Notes:

- \* Denotes minimum "K" to be used for each design speed.
- Sight distance "d" is established by GB criteria for the intersection sight distance of Case B1 (Left Turn from the Minor Road for Intersections with Stop Control on the Minor Road). Refer to GB Chapter 9 Section 9.5.3 for more information.
- Minimum "K" for stopping sight distance according to GB. Refer to GB Chapter 3 Section 3.4.6 Table 3-35.
- "K" derived from GB Chapter 3 Section 3.4.6 Formula 3-42 (applying  $K = L / A$ ) using  $h_1 = 7.6'$  as the eye height of a truck driver and  $h_2 = 4.35'$  as the object height of a vehicle as suggested in GB Chapter 9 Section 9.5.2.
- "K" derived from GB Chapter 3 Section 3.4.6 Formula 3-42 (applying  $K = L / A$ ) but assuming a rail height of 2.67' and subtracting said rail height from the eye and object heights ( $h_1 = 4.93'$ ,  $h_2 = 1.68'$ ).

$$K = \frac{d^2}{100 (\sqrt{2h_1} + \sqrt{2h_2})^2}$$

Figure 9-4 Vertical Sight Distance Control for Crest Curves at Interchanges, Single Unit Vehicle Criteria

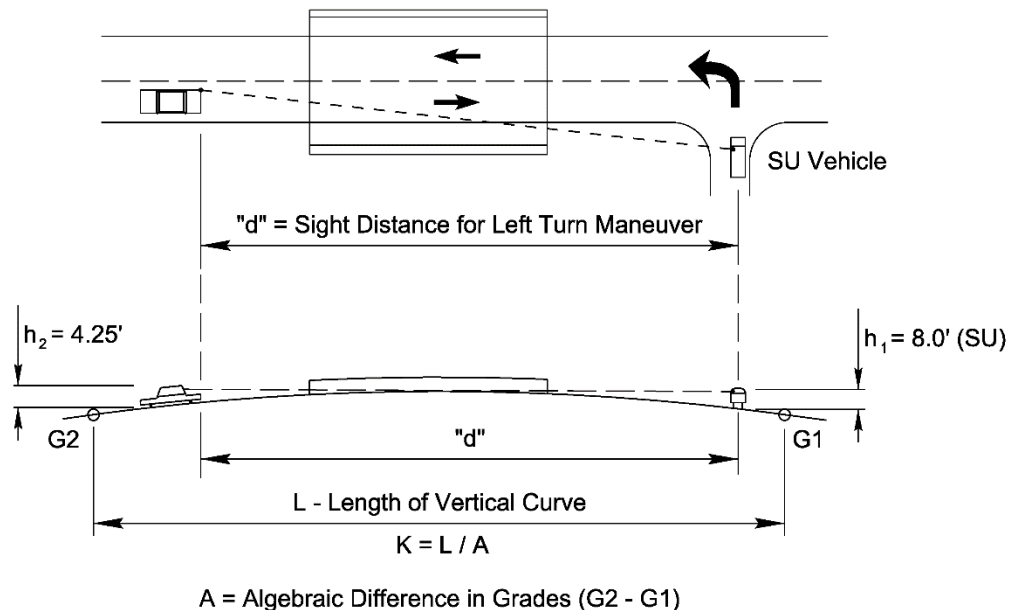

Note: Vertical sight distance should be provided in combination with horizontal sight controls. The design data listed in Table 9-3 is based on utilizing the SU vehicle as the ramp vehicle. With a passenger car as the ramp vehicle, the sight distance provided with the design data listed in Table 9-3 allows for approach speeds greater than the crossroad design. With a combination truck, the available sight distance allows for approach speeds of about 80 percent of the crossroad design speed, which is approximately the average running speed of the crossroad traffic.

Figure 9-5 Design Requirements for Crossroad Sight Distance at Interchanges, Single Unit Vehicle Criteria

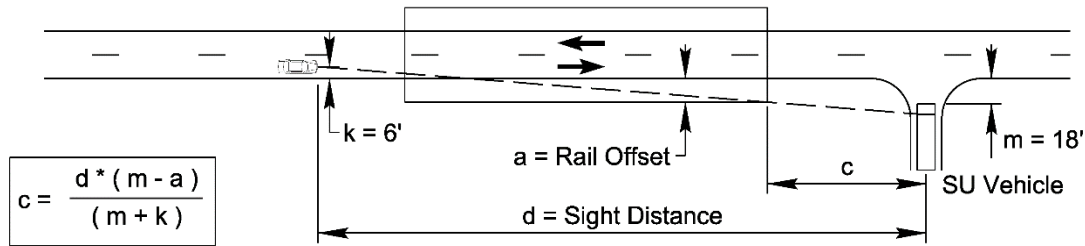

Notes:

1. Definitions
  - "a" - Offset from the edge of the travel lane to the inside edge of the bridge rail.
  - "c" - Distance required from the end of the bridge to the decision point on the ramp terminal.
  - "d" - Sight distance measured along the major road of the intersection sight triangle.
  - "k" - The offset from the major road edge of the travel lane to the decision point of the departure sight triangle on the major road.
  - "m" - The offset from the major road edge of the travel lane to the decision point of the departure sight triangle on the minor road (ramp terminal).
2. Sight distance "d" is established by GB criteria for the intersection sight distance of Case B1 (Left Turn from the Minor Road for Intersections with Stop Control on the Minor Road). Refer to GB Chapter 9 Section 9.5.3 for more information.
3. Decision point offsets "k" and "m" are set based on guidance in GB. Refer to GB Chapter 9 Section 9.5.

Table 9-4 "c" Distance Required from End of Bridge to Ramp Terminal

Design Speed (mph)	Rail Offset (ft) "a"				
	2'	4'	6'	8'	10'
15	140'	125'	105'	90'	70'
20	190'	165'	140'	120'	95'
25	235'	205'	175'	150'	120'
30	280'	245'	210'	175'	140'
35	330'	290'	245'	205'	165'
40	375'	330'	280'	235'	190'
45	420'	370'	315'	265'	210'
50	470'	410'	350'	295'	235'
55	515'	450'	385'	325'	260'
60	560'	490'	420'	350'	280'
65	610'	535'	455'	380'	305'
70	655'	575'	490'	410'	330'
75	700'	615'	525'	440'	350'
80	750'	655'	560'	470'	375'

Note: Distances "c" in Table 9-4 are determined based on the formula shown in Figure 9-5 above using "m" = 18' and "k" = 6'. Sight distance "d" is determined using GB Chapter 9 Section 9.5.3 Formula 9-1, the values in GB Table 9-6 (t<sub>g</sub> = 9.5 s), and assuming an approach grade flatter than 3 percent. Refer to GB Chapter 9 Section 9.5. Use formula shown in Figure 9-5 to calculate "c" for all other conditions.

Refer to GB Chapter 3 Section 3.2 and Chapter 7 Section 7.2.2.4 for sight distance criteria.

Design all ramp terminals to handle the WB-62FL design vehicle. Refer to RDM Part I Chapter 8 Section 8.5 for additional information.

Pay special attention at ramp terminals to discourage wrong-way entry. At locations with unusual ramp termini configurations, consider a raised median on the -Y- line.

On partial cloverleaf and diamond type interchanges, provide a recovery area for left turning vehicles (turning lane), as shown in Figure 9-6. Figures 9-6 and 9-7 show a typical transition for pavement widening at interchange ramp terminals.

Figure 9-9 and Figure 9-10 show designs for loop ramp terminal radii that will provide safe ingress movements for speeds between 20 and 25 mph. In designing ramps, use these designs as an absolute minimum. Flatter radii may be provided if the designer feels the conditions warrant their use.

Figure 9-10 identifies acceptable ramp terminal skews.

Figure 9-6 -Y- Line Transition at Ramp Terminal for Three-Lane -Y- Line Section

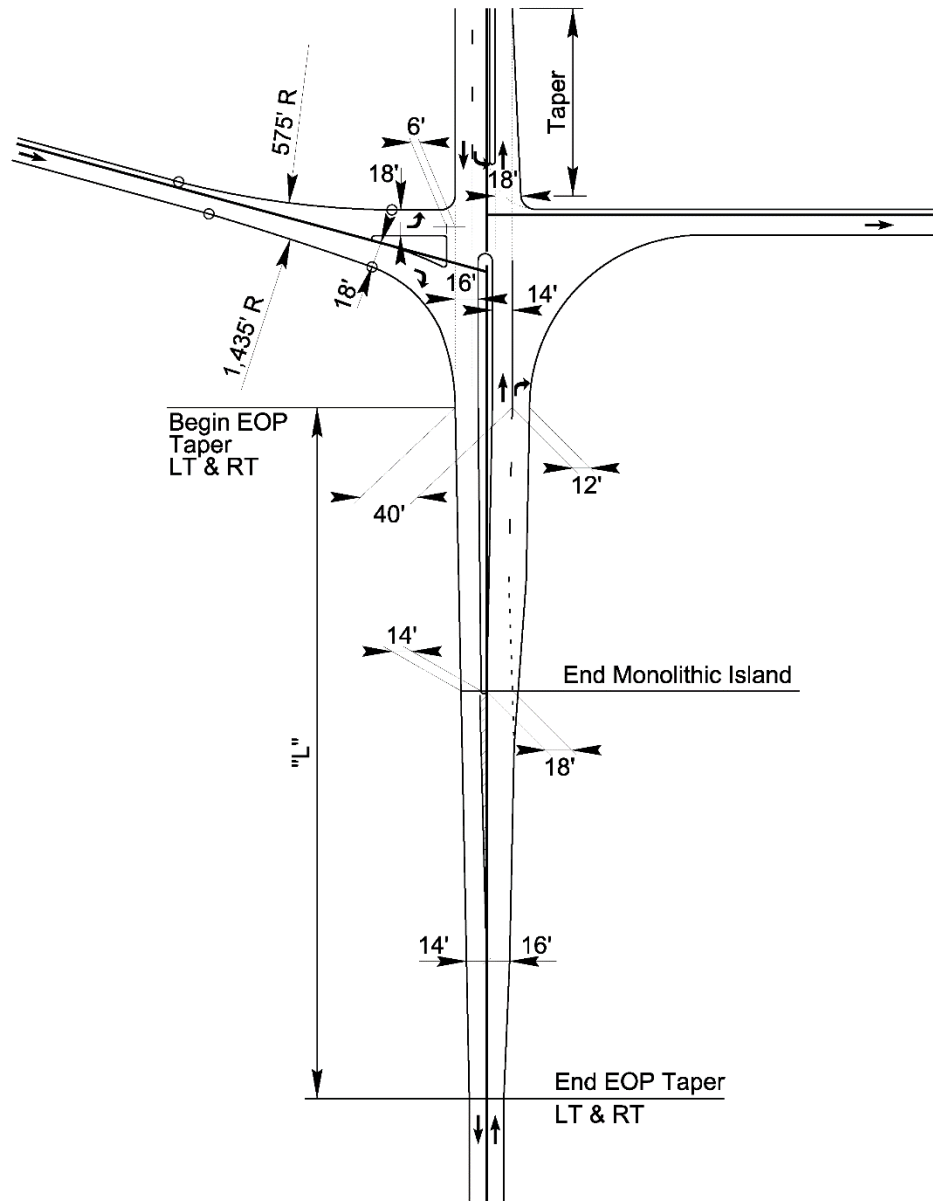

## Notes:

1. Begin EOP taper at the location of the last radius.
2. Location of end of island to be determined by prohibiting a left turn move.
3. Right turn warrants and length should be according to RDM Part I Chapter 8.
4. Five-lane -Y- line section should be set up the same as the three-lane section with additional lanes on the outside.
5. Taper length "L" should be as follows:
  - a. Tapers for design speeds of 45 mph and above should use  $L = S \cdot W$
  - b. Tapers for design speeds of less than 45 mph should use  $L = W \cdot S^2 / 60$

L = Length of taper  
W = Offset in feet  
S = Design speed



Figure 9-7 Ramp Terminal Design

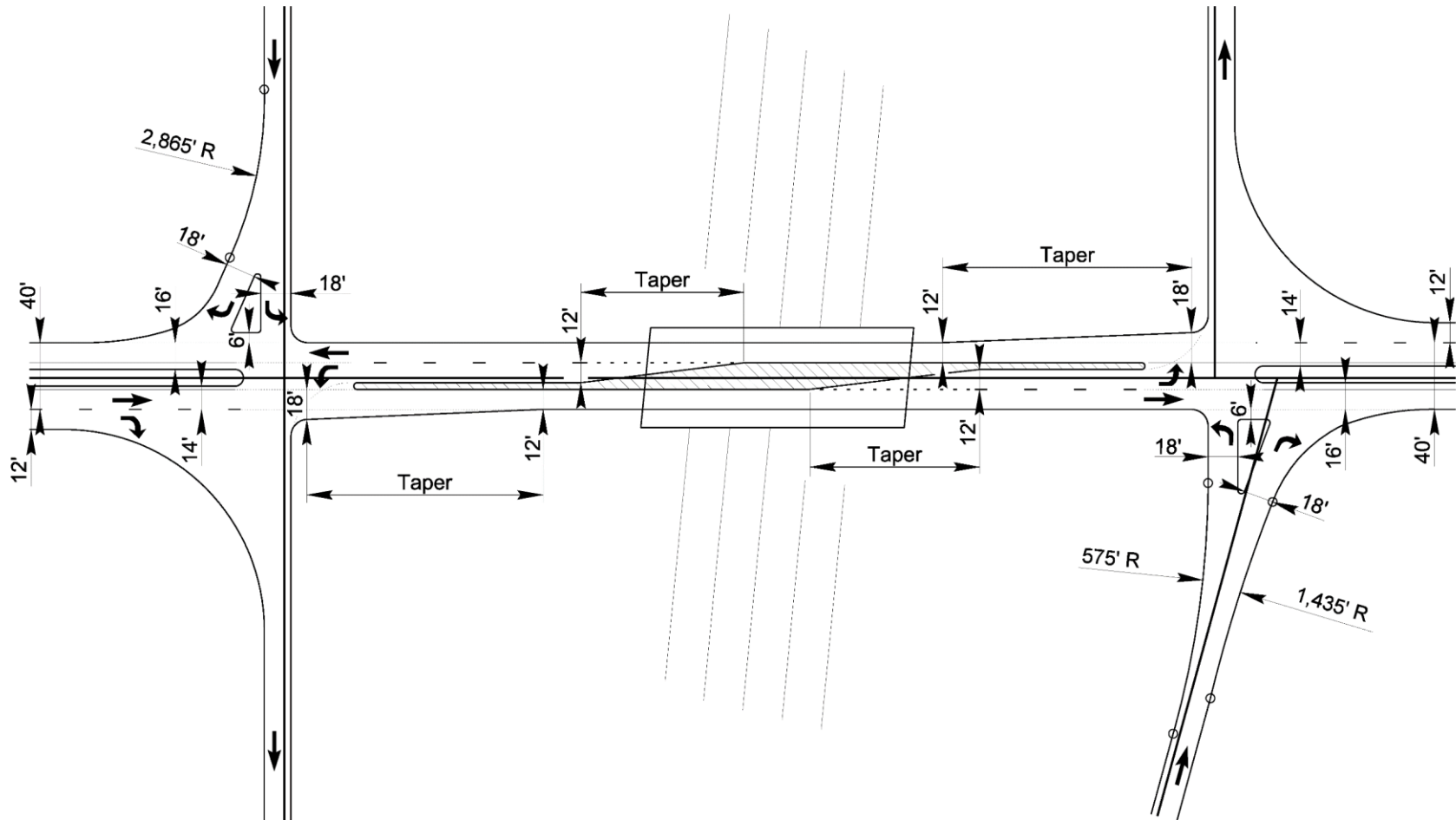

Notes:

1. For a three-lane -Y- line section, a painted island is acceptable, or it can be eliminated completely. On a five-lane -Y- line section, a concrete island should be utilized to separate opposing traffic on the bridge.
2. Turning movements should be designed for a WB-62FL.

Figure 9-8 Plan for Loop Ramp Terminal Combination

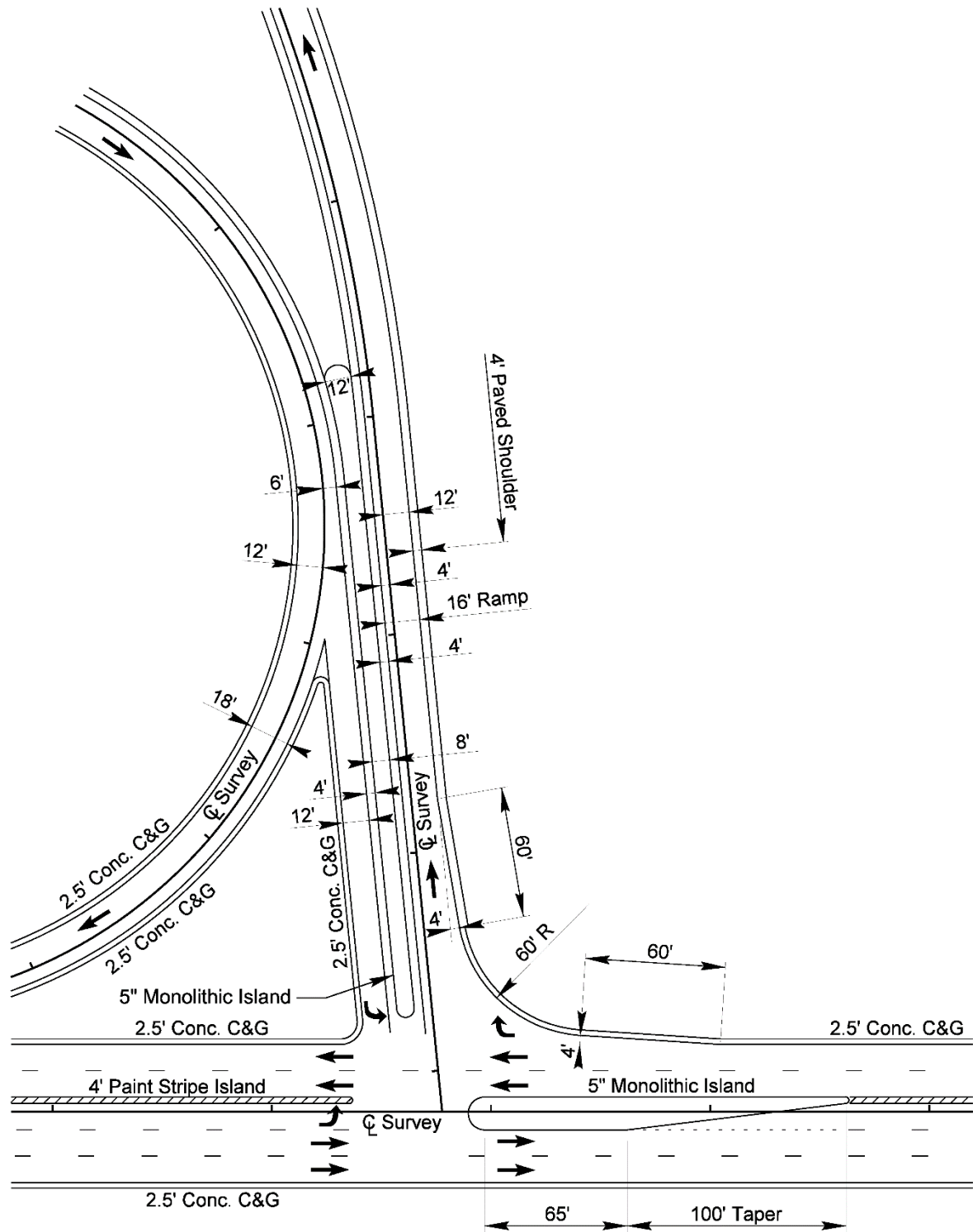
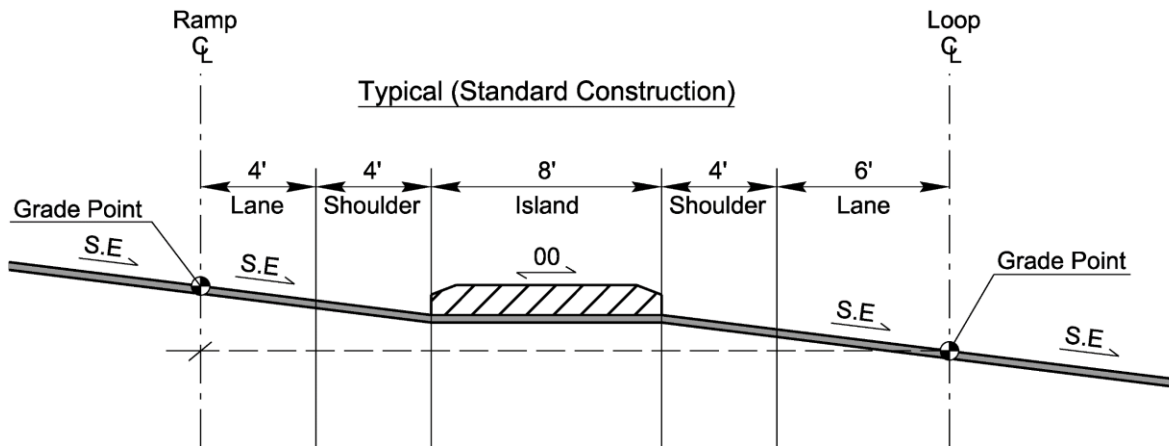
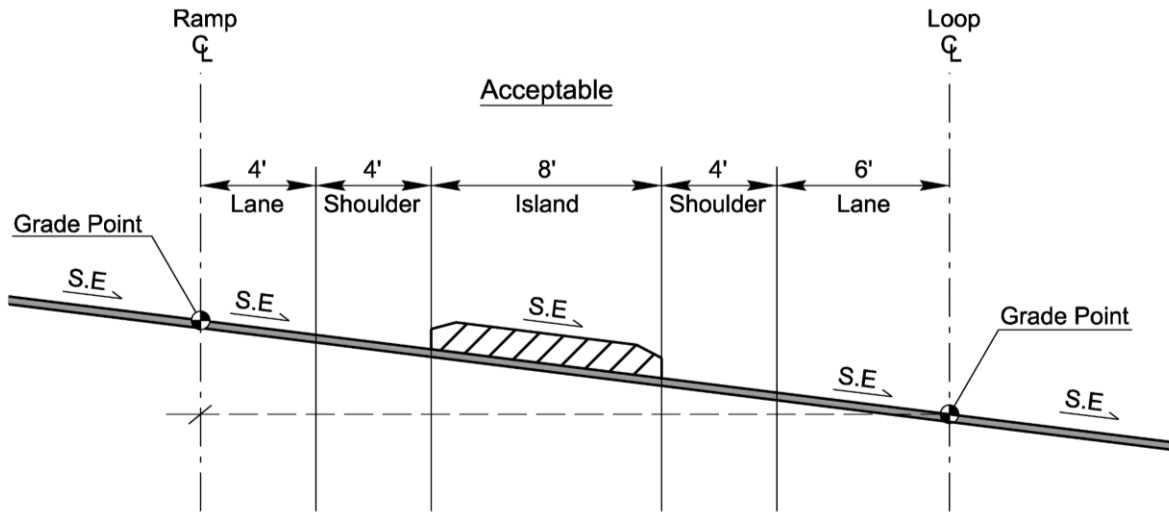

Figure 9-9 Section View for Loop Ramp Terminal Combination



Note: In typical scenario the island is constructed at 0.0% cross-slope.



Note: In acceptable scenario the island can be superelevated to match the adjacent roadway cross-slopes.

Figure 9-10 Acceptable Ramp Terminal Skews

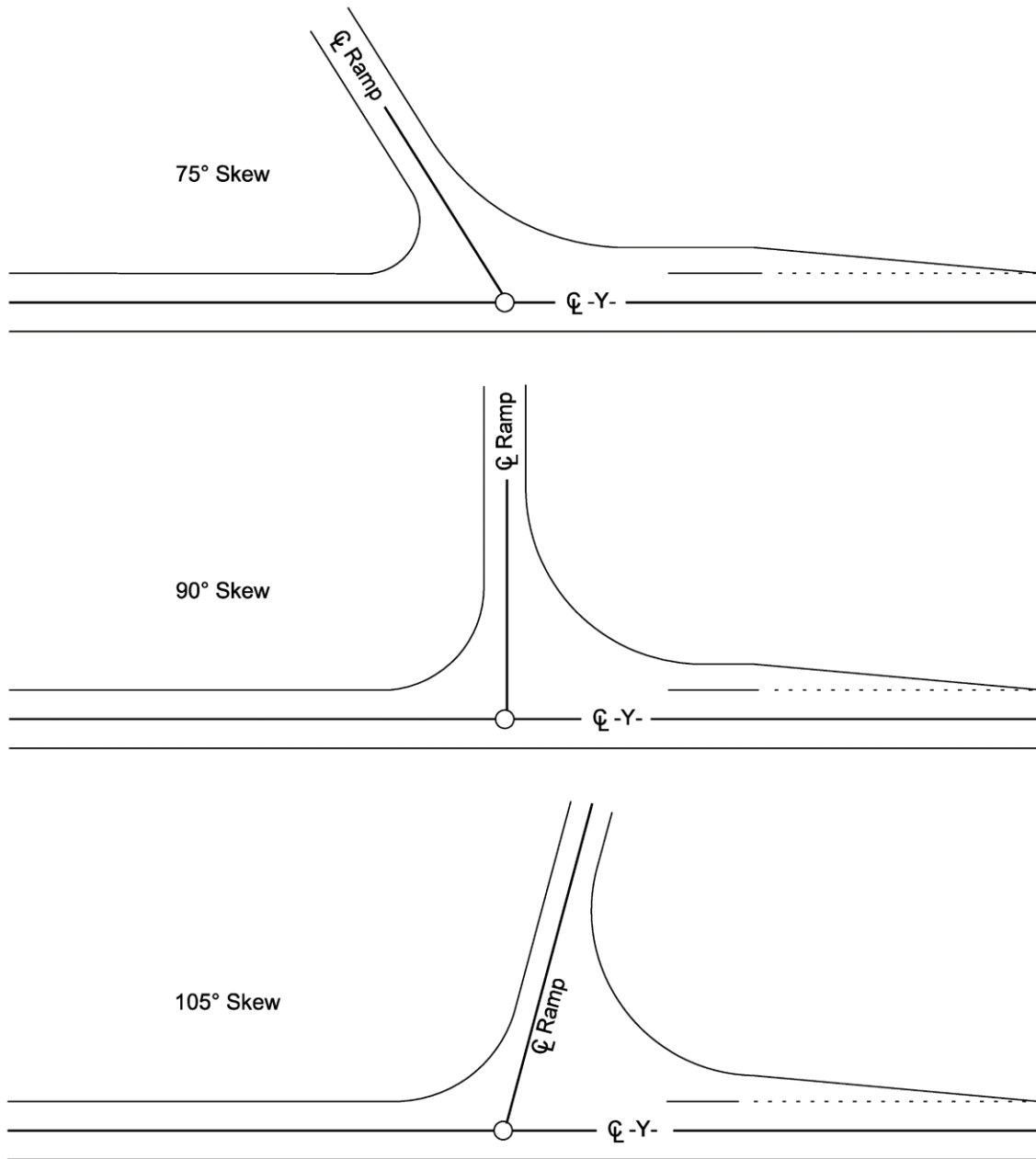

Note: 90° is the preferred ramp skew. Anything within the range of 75° and 105° is considered acceptable.

Refer to GB Chapter 10 Section 10.9.6.4 for more information on terminal location and sight distance.

### 9.4.3.2 Distance Between Successive Ramp Terminals on Freeway

The distance between successive ramp terminals needs to be long enough to provide adequate weaving distance and sign spacing for motorists. Table 9-5 presents the recommended minimum distances between successive ramp terminals.

Table 9-5 Recommended Minimum Ramp Terminal Spacing

EN-EN or EX-EX		EX-EN		Turning Roadways		EX-EN (Weaving)			
Full Freeway	CDR	Full Freeway	CDR	System Interchange	Service Interchange	System to Service Interchange		System to Service Interchange	
						Full Freeway	CDR	Full Freeway	CDR
<b>Minimum Lengths Measured Between Successive Ramps Terminals</b>									
1000 ft	800 ft	500 ft	400 ft	800 ft	600 ft	2000 ft	1600 ft	1600 ft	1000 ft

Notes:

1. Arrangement for successive ramp terminals
  - a. FWY - Freeway
  - b. CDR – Collector Distributor
  - c. EN – Entrance
  - d. EX – Exit
2. The recommendations presented in Table 9-5 are based on operational experience and the need for flexibility and adequate signing. They should be checked in accordance with the procedure outlined in the TRB *Highway Capacity Manual* 6th Edition (HCM) and the larger of the values is suggested for use. Also, the procedure for measuring the length of the weaving section is given in the HCM. The distances labeled “L” in Table 9-5 are measured between the painted noses; refer to GB Chapter 10 Section 10.9.6.2 Figure 10-63. A minimum distance of 300 feet is recommended between the end of the taper for the first entrance ramp and the painted nose for the succeeding entrance ramp.

Source: GB Chapter 10 Section 10.9.6.4.6 Figure 10-70.

Refer to GB Chapter 10 Section 10.9.6.4.6 for more information on distance between successive ramp terminals.

### 9.4.4 Single Lane Free Flow Terminals, Entrances

A single lane entrance ramp can be a taper-type or parallel type.

Typically, use parallel type entrance ramps on new facilities. When adding or reconstructing an interchange on an existing facility, maintain the exit and entrance type if a definite pattern has been established on the freeway segment. Provide sufficient length to enable a driver to make the necessary change between the speed of operation on the highway and the speed on the turning roadway in a safe and comfortable manner.

Refer to GB Chapter 10 Section 10.9 Table 10-4 for minimum acceleration lengths for ramp entrances.

The following sections provide greater detail of each entrance type.

#### 9.4.4.1 Taper-Type Entrances

When designed properly, a taper-type entrance ramp (also referred to as an angular entrance or exit) can function smoothly. Taper-type entrance ramps are not typically used in North Carolina.

[NCDOT Roadway Standard Drawings](#), Std. No. 225.03 provides details on taper-type entrances.

Refer to GB Chapter 10 Section 10.9.6.5.1 for more information on taper-type entrances.

#### 9.4.4.2 Parallel-Type Entrances

Use parallel type entrance lanes in locations where existing interchanges facilities are being upgraded and where right of way is at a premium. The parallel entrance provides additional ramp length (full lane) parallel to the mainline facility allowing the driver adequate time to accelerate and merge.

Parallel entrance ramps are preferred in North Carolina.

[NCDOT Roadway Standard Drawings](#), Std. No. 225.03 provides details on parallel-type entrances.

Refer to GB Chapter 10 Section 10.9.6.5.2 for more information on parallel-type entrances.

### 9.4.5 Single Lane Free Flow Terminals, Exits

Typically, use taper-type (angular) exit ramps for single lane exits on new facilities. The angular exit separates the exiting vehicle from the mainline traffic. Angular exits are the preferred exit ramp treatment as this provides the fastest separation of through traffic and traffic exiting the through way. When adding or reconstructing an interchange on an existing facility, maintain the exit and entrance type if a definite pattern has been established on the freeway segment. Provide sufficient length to enable a driver to make the necessary change between the speed of operation on the highway and the speed on the turning roadway in a safe and comfortable manner.

Refer to GB Chapter 10 Section 10.9.6.5.2 Table 10-5 for minimum deceleration lengths for ramp exit.

#### 9.4.5.1 Taper-Type Exits

Taper-type exits are ramp terminals that exit the throughway at an angle. The taper-type exits at a high level of service and provides a definitive and direct exit location. This direct exit path is preferred by most drivers.

The typical angle of departure for angular type exit ramps is between 2 degrees, 18 minutes and 4 degrees, 7 minutes.

[NCDOT Roadway Standard Drawings](#), Std. No. 225.03 provides details on taper-type exits.

Refer to GB Chapter 10 Section 10.9.6.6.1 for more information on taper-type exits.

#### 9.4.5.2 Parallel-Type Exits

A parallel-type exit begins with a taper followed by a deceleration lane parallel to the through way. Refer to GB Chapter 10 Section 10.9 Table 10-6 for minimum deceleration lengths for ramp exits on flat grades.

[NCDOT Roadway Standard Drawings](#), Std. No. 225.03 provides details on parallel-type exits.

Refer to GB Chapter 10 Section 10.9.6.6.2 for more information on parallel-type exits.

### 9.4.5.3 Free-Flow Terminals on Curves

When ramp exits and entrances are located in sharper curves on the throughway, adjustments to the ramp designs will be required to avoid operational difficulties.

Refer to GB Chapter 10 Section 10.9.6.6.3 and Figures 10-74a and 10-74b for more information on free-flow ramp terminals on curves.

### 9.4.5.4 Multilane Free-Flow Terminals

When single lane ramp terminals do not provide enough capacity, consider a multilane ramp terminal.

### 9.4.5.5 Two-Lane Entrances

Two-lane entrances are needed when there are branch connections or when the lanes are needed for increased capacity.

Refer to GB Chapter 10 Section 10.9.6.6.5 and Figure 10-76 for more information on two-lane entrances.

### 9.4.5.6 Two-Lane Exits

Two-lane exits should be provided when the exiting traffic volume exceeds the capacity of a single lane ramp exit. For two-lane exit ramps, NCDOT preference is to make both lanes of the exit ramps parallel to the through way lane.

Refer to GB Chapter 10 Section 10.9.6.6.6 and Figure 10-77 for more information on two-lane exits.

## 9.5 Other Interchange Design Features

### 9.5.1 Managed Lanes and Transit Facilities

When developing a new interchange design or upgrade to an existing interchange consider accommodations for managed lanes and/or transit facilities during the planning and design for all grade separations and interchanges.

Refer to GB Chapter 10 Section 10.9.7.3, and [NCDOT Complete Streets Guide](#) for more information on accommodating managed lanes and transit facilities within an interchange.

### 9.5.2 Ramp Metering (also known as On-Ramp Signals)

Ramp metering is a method of controlling the flow of vehicles entering the freeway through the use of signal timing on the entrance ramp.

Refer to GB Chapter 10 Section 10.9.7.4 for more information on ramp metering.

Refer to [NCDOT Safety and Mobility Website](#) for more information on On-Ramp Signals.

### 9.5.3 Pedestrian and Bicycle Accommodations

Interchange locations tend to result in high density land usage which can generate a large amount of pedestrian traffic. Consider pedestrian and bicycle accommodations in the early phases of the planning and design of grade separations and interchange modifications including

reviewing marked crosswalks at intersections, bicycle lane transitions to the intersections, pedestrian and bicycle detection, pedestrian signal phases at signalized intersection crossings, tighter turn radii at intersections with pedestrian crossings, and restricted turning movements where in conflict with permitted walk or thru-bicycle phases.

#### 9.5.4 Median Designs in Interchange Areas

If a median is continuous, do not reduce the median width of a facility through an interchange on either the mainline or the intersection highway (-Y- line).

~~Provide traffic islands on -Y- lines within the interchange for highways with four or more lanes. On facilities with three lanes, provide a 4foot painted island. Obtain justification for a left turn lane(s) on the -Y- line from the capacity analysis information.~~

- Consider adding left-turn lanes along all minor roads at interchanges.
- Consider adding island channelization along all minor roads at interchanges.
- Consider, at a minimum, adding intersection channelization at the intersections to reduce the potential for wrong-way movements.
- Coordinate with the Regional Field Operations Engineer in the Traffic Safety Unit to assist in decision-making for channelization and the Congestion Management Regional Engineer in the Traffic Management Unit to assist in decision-making for turn lanes.

#### 9.5.5 Grading at Interchanges

Flatten slopes to 4:1 or flatter where feasible within the interchange. This provides better sight distance, eliminates the need for guardrail, and allows for landscaping and mowing. Interior slopes steeper than 4:1 should be discussed with the Division and Technical Lead. Topographic conditions, wetlands, property impacts, and earthwork requirements may dictate steeper or flatter slopes.

Provide sight distance on all entrance ramps to allow time for the motorist to adjust their speed to the available gaps in traffic flow. The entire interchange shall be graded to provide adequate sight distances. The area beyond the exit gore should provide a traversable safety zone as well as a safe transition to the standard typical section. Slopes within 300 feet of the nose of the gore should be 6:1 or flatter.

Refer to [NCDOT Roadway Standard Drawings](#), Std. Nos. 225.07 and 225.09 for slope transitions at bridge end bents.



This page intentionally left blank.

# Chapter 10 Additional NCDOT Design Resources

## 10.1 Introduction

The purpose of all roadway networks is to provide connectivity for society; however, considerations should be made for safe and efficient connections to this roadway network. This chapter provides links to additional NCDOT resources and requirements for the connection of the roadway network.

## 10.2 Subdivision Roads – Minimum Construction Standards

If a new subdivision road (to be dedicated as public or private) will connect to a roadway on the state system, obtain a driveway permit or encroachment agreement authorizing construction on state right of way from the Division of Highways before beginning any construction. Submit applications to the District Engineer having jurisdiction in the area. On active State Transportation Improvement Program (STIP) projects, the District Engineer must coordinate with the NCDOT project manager.

Refer to the latest version of NCDOT Subdivision Roads – Minimum Construction Standards available on the [NCDOT Secondary Roads and Subdivisions](#) page of the Connect NCDOT website for complete information on requirements for subdivision roads.

Refer to Figures 1 through 9 in [NCDOT Subdivision Roads – Minimum Construction Standards](#) for detailed information regarding the required roadway typical section, connection width at intersections to state owned roads, and construction requirements.

## 10.3 Resurfacing, Restoration, and Rehabilitation of Highways and Streets

The primary purpose of resurfacing, restoration, and rehabilitation (R-R-R) projects is to provide a better riding surface, enhance safety, improve operating conditions, and preserve and extend the service life of existing non-freeway facilities. Highway safety is an essential element of R-R-R projects. Develop and design projects in a manner which identifies and incorporates safety improvements. Economic considerations are a major factor in determining the priority and scope of R-R-R projects.

The R-R-R guidelines provide the designer options for improving existing facilities and minimizing impacts to the project corridor. Not all projects are candidates for these guidelines. Ideally, these projects are identified in the Transportation Improvement Program. Coordinate with the NCDOT Project Manager and other appropriate NCDOT staff to determine if a specific project qualifies prior to initiating design work on a project:

The [NCDOT Resurfacing, Restoration, and Rehabilitation \(R-R-R\) of Highways and Streets](#) document is in the process of being updated to reflect NCHRP Report 876 which employs a cost-effectiveness approach to decision making for corridor improvements.

## 10.4 Supplemental Street and Driveway Access Guidelines

### 10.4.1 General Considerations

One of the primary concerns of those responsible for North Carolina's vast highway system is to provide for the safe and efficient movement of people and goods. As an aid in achieving this,

NCDOT published a Policy on Street and Driveway Access to North Carolina Highways, establishing requirements for the location, design, and construction of street and driveway access connections to the State Highway System.

The NCDOT Congestion Management Section maintains the policy document which is currently in the process of being edited with an anticipated release date in 2022. The update will focus primarily on general policy, while technical content related to design elements will reside in the RDM. This chapter of the RDM contains design elements related to street and driveway access that are useful to the roadway designer and that are intended to be removed from the policy document.

Refer to the latest version of [NCDOT Policy on Street and Driveway Access to North Carolina Highways](#) for more information on street and driveway access policies.

## 10.4.2 Technical Design Guidelines

The intent of the following information is to extract from the policy document all the information that communicates technical design criteria such as dimensional, slope, rate, and clearance data and bring it into the RDM. The intent of this content migration is to allow future revisions of the policy (subject to approval by the NCDOT Board of Transportation) to include only policy directives as opposed to the current mixture of both policy directives and technical design guidelines. This would allow the Roadway Design Unit to update technical design criteria over time through changes to the RDM, without having to revise and seek Board approval for the overall policy document.

### 10.4.2.1 Site Requirements

- **Functional Area of Intersection** – The functional area of an intersection consists of the distance traveled during reaction time, the deceleration distance, and queue storage length. The following reaction time and distances may be used:

**Table 10-1 Reaction Time and Distances for Functional Area of Intersections**

Reaction Time and Distance				
Areas	Sec.	35 mph	45 mph	55 mph
Rural	3.0	155 ft	200 ft	245 ft
Urban	9.1	470 ft	600 ft	735 ft

The reaction distance values shown in Table 10-1 were developed using GB Equation 3-5.

Avoid driveways within the storage and deceleration length of an intersection. Median breaks are not allowed within the storage length, deceleration length, or length of reaction time shown in Table 10-1.

Refer to Figure 10-1 for clarification on the functional area of an intersection.

Refer to GB Chapter 3 Section 3.2.3 for additional information on design sight distance.

Figure 10-1 Functional Area of an Intersection

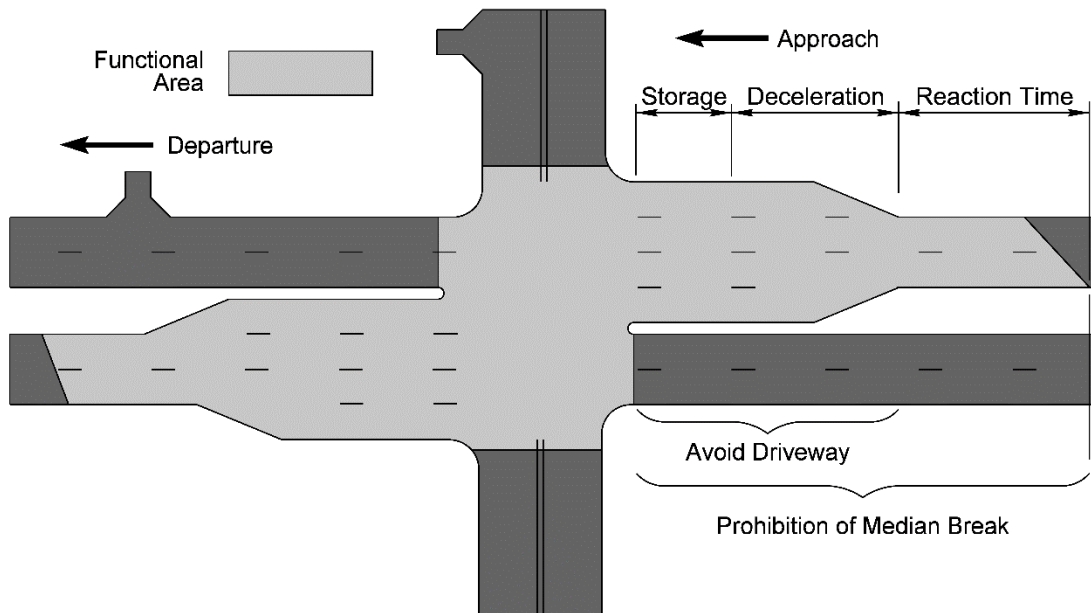

- **Sight Distance** – Refer to RDM Part I Chapter 8 Section 8.4 for guidance on intersection sight distance.
- **Vehicle Storage Space and Driveway Stem** – NCDOT has the authority and responsibility to require adequate internal storage and a sufficient length of protected stem within the right of way of a site, to ensure operational and safety needs of the adjacent roadway system. For example, a restaurant drive-thru line should not back up into the adjacent roadway and a driveway exit from a site should be of sufficient length to not inhibit vehicles from entering a site.

Refer to [NCDOT Policy on Street and Driveway Access to North Carolina Highways](#) Chapter 7 Section B for guidance on internal storage space and driveway stems accessing state highways.

- **Driveway Radius** – A primary concept in designing a driveway connection is to minimize the interference with traffic flow on adjacent streets. To accomplish this, use a driveway radius with the ability to handle the types of vehicles designated to use the driveway. A properly designed driveway radius will minimize the impact of turning traffic on through traffic. Consider the effects of a driveway radius on pedestrian and bicycle safety and mobility. Limit the radius of the street-type driveway connections to 20 feet minimum and 50 feet maximum.

Refer to Figure 10-2 for an illustration of adequate and inadequate turn radii.

Figure 10-2 Intersection Turn Radii

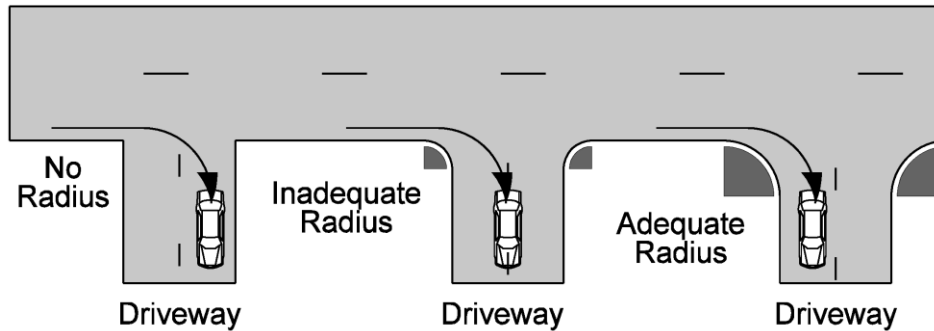

Note: An adequate radius allows turning vehicles to access the site readily and minimizes the impact to the through movement.

- Driveway Profiles – Refer to RDM Part I Chapter 4 Section 4.12.1 for guidance on driveway profiles.
- Subdivision Road Standards – Design residential subdivisions in accordance with the requirements set forth in the current edition of [NCDOT Subdivision Roads – Minimum Construction Standards](#).

#### 10.4.2.2 Number and Arrangements of Driveways

Refer to [NCDOT Policy on Street and Driveway Access to North Carolina Highways](#) Chapter 7 Section C for guidance on the number, spacing and arrangements of driveways along state highways.

#### 10.4.2.3 Maintenance Limits

Refer to [NCDOT Policy on Street and Driveway Access to North Carolina Highways](#) Chapter 7 Section G for public (NCDOT) and private maintenance limits and requirements.

#### 10.4.2.4 Control Dimensions

Comply with the following control dimensions for street and driveway connections for commercial and private development. Refer to Figures 10-4, 10-5, and 10-6 for example applications of these control dimensions.

For residential driveways, the designer should coordinate with the Division early in the design process to determine the Division's preference for the appropriate treatment and accepted design approach.

- Width of Driveways (W) – The width of driveways, W, measured parallel to the edge of travel way and from edge of pavement to edge of pavement at the narrowest width, shall be within the specified minimum and maximum limits.

A driveway with two-way operations shall have a minimum 20-foot and a maximum 36-foot width. A driveway with one-way operation shall have a minimum 12-foot and a maximum 24-foot width. The need for wider driveways will be considered on a case-by-case basis only after justification of actual necessity but should not exceed 50 feet. Provide a minimum 20-foot driveway width for standard driveway turnouts in conjunction with curb and gutter (Refer to Std. No. 848.02 and Std. No. 848.03).

Street type connections with multilane ingress or egress may exceed 50 feet based on traffic operation requirements as demonstrated in the traffic impact study for the project.

These values are based on edge of pavement dimensions not including the width of gutter if a curb-and-gutter section is proposed.

Refer to Figure 10-3 for a recommended high volume driveway connection.

Figure 10-3 Three Lanes at Major Drives

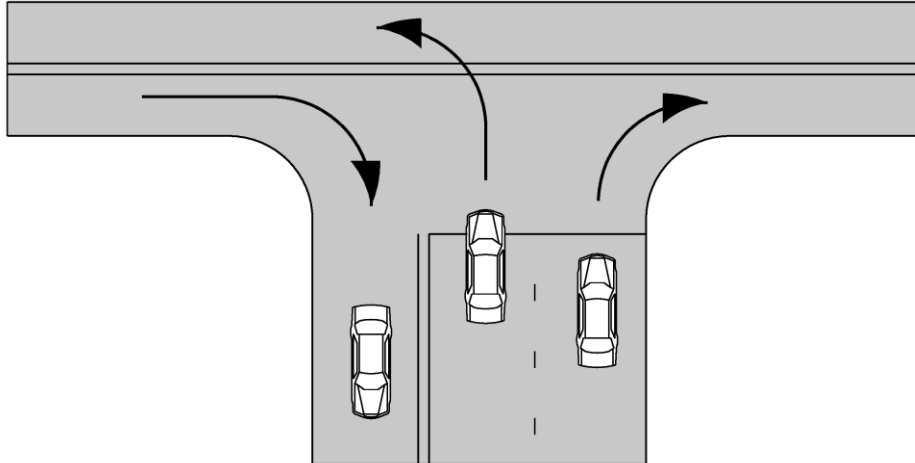

Note: When driveway volumes are moderate or high, a three-lane cross section should be recommended.

- **Driveway Angle (Y)** – The recommended driveway angle, Y, for a full access driveway is 90 degrees. The angle of the two-way operation driveway with respect to the pavement edge shall not be less than 75 degrees or greater than 90 degrees. For one-way right-in or right-out driveways, driveway angles between 45 and 90 degrees may be allowed on a case-by-case basis.
- **Edge Clearance (E)** – All portions of a commercial driveway including the returns shall be between two frontage boundary lines of the current or future right of way line. The edge clearance, E, measured parallel to the edge of pavement from the frontage boundary line to the nearest point on the projected edge of the driveway shall be a minimum of 20 feet.
- **Driveway Return (R)** – The radius of the street-type driveway connection, R, shall be within 20 feet desirable (5 feet minimum) and 50 feet maximum. However, the maximum radii dimension may be exceeded as an exception if larger radii are needed to accommodate larger vehicles expected to frequent a proposed development such as commercial service entrances, service stations being serviced by tanker trucks, or truck terminals.
- **Island Offset Distance (S)** – The near edge of an island area parallel to the highway shall be located no less than 6 feet and no more than 12 feet from the edge of pavement along uncurbed roadways or from the curb line on curbed roadways unless specifically instructed by District Engineer to be otherwise.
- **Distance Between Driveways (D)** – Where more than one driveway is permitted along a single property frontage, the distance, D, measured along the right of way line between the tangent projection of the inside edges of adjacent driveways shall be at least 100 feet. For high volume traffic generators, the minimum distance between the centerlines of full movement driveways, or between a full movement driveway and the next nearest full movement roadway, into developments that generate high traffic volumes should be at least 600 feet for most non-critical transportation corridors and a

minimum of 1,000 feet for Major Thoroughfares, National Highway System and Intrastate Routes, Primary Routes, and corridors with identified safety concerns. This minimum distance between driveways does not apply to service drives not used by the general public.

- **Setbacks (G)** – Setbacks of gasoline pump islands parallel to the pavement edge shall be a minimum of 25 feet outside the highway right of way. Setbacks of gasoline pump islands not parallel to the pavement edge shall be a minimum of 50 feet outside the highway right of way. Buildings or other installations with one row of 90-degree parking between it and the highway right of way should be at least 50 feet outside the right of way. Buildings or other installations with one row of angle parking between it and the highway right of way should be at least 30 feet outside the right of way. All expected vehicular movements needed to serve a site must be accommodated internally.
- **Corner Clearance (C)** – Where the property's road frontage allows, the minimum corner clearance to the proposed driveway should be at least 100 feet from the point of tangency of the radius curvature of the intersecting streets. At no time shall the corner clearance be less than 50 feet from the points of tangency of the radius curvature. For full movement driveway connections at signalized intersections, the corner clearance may be required to extend beyond 100 feet when the property's road frontage allows. This is to avoid interference with the traffic signal operations and resulting traffic queues. The radius of the driveway should not encroach on the minimum corner clearance.

### 10.4.3 Figures

The following figures provide illustrations of example applications of the control dimensions for street and driveway connections described in Section 10.4.2.4.

Figure 10-4 Example Driveway Scenario for Corner Business

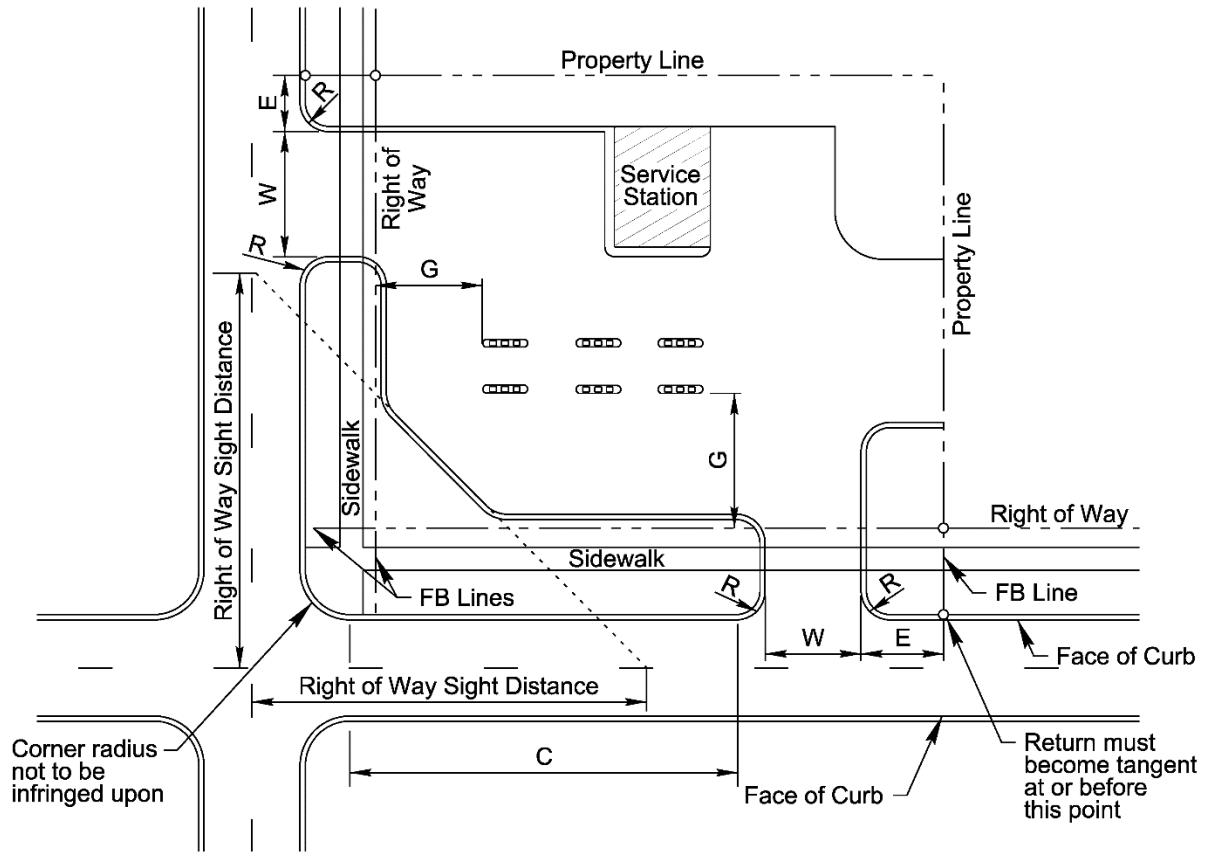

Notes:

1. Access to major facilities may not be allowed if suitable access is available to other public facilities.
2. Connectivity to adjacent property recommended.
3. E - 20' minimum
4. R - 5' minimum, 30' maximum
5. G - 50' minimum where pump islands are perpendicular to right of way. 25' minimum where pump islands are parallel to right of way.
6. W - One way: 12' minimum, 24' maximum. Two way: 20' minimum, 36' maximum
7. C - 50' minimum, 100' desirable
8. FB - Frontage boundary line



Figure 10-5 Angled Driveways on One-Way Streets

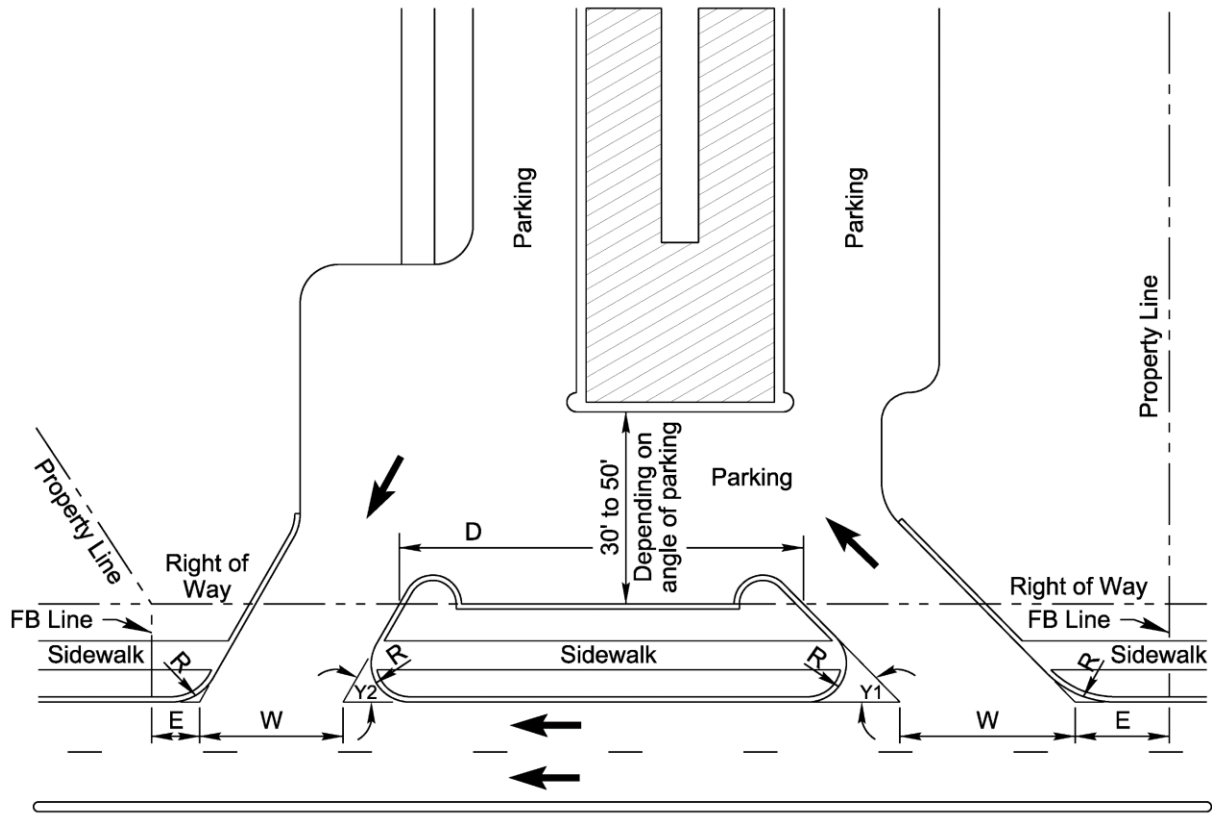

Notes:

1. Access to major facilities may not be allowed if suitable access is available to other public facilities.
2. Connectivity to adjacent property recommended.
3. E - 20' minimum
4. W - One way: 12' minimum, 24' maximum
5. Y1 - 45° minimum (one way roadway)
6. Y2 - 60° minimum (one way roadway)
7. D - 100' minimum
8. FB - Frontage boundary line

Figure 10-6 Driveway with Controlled or Restricted Entry

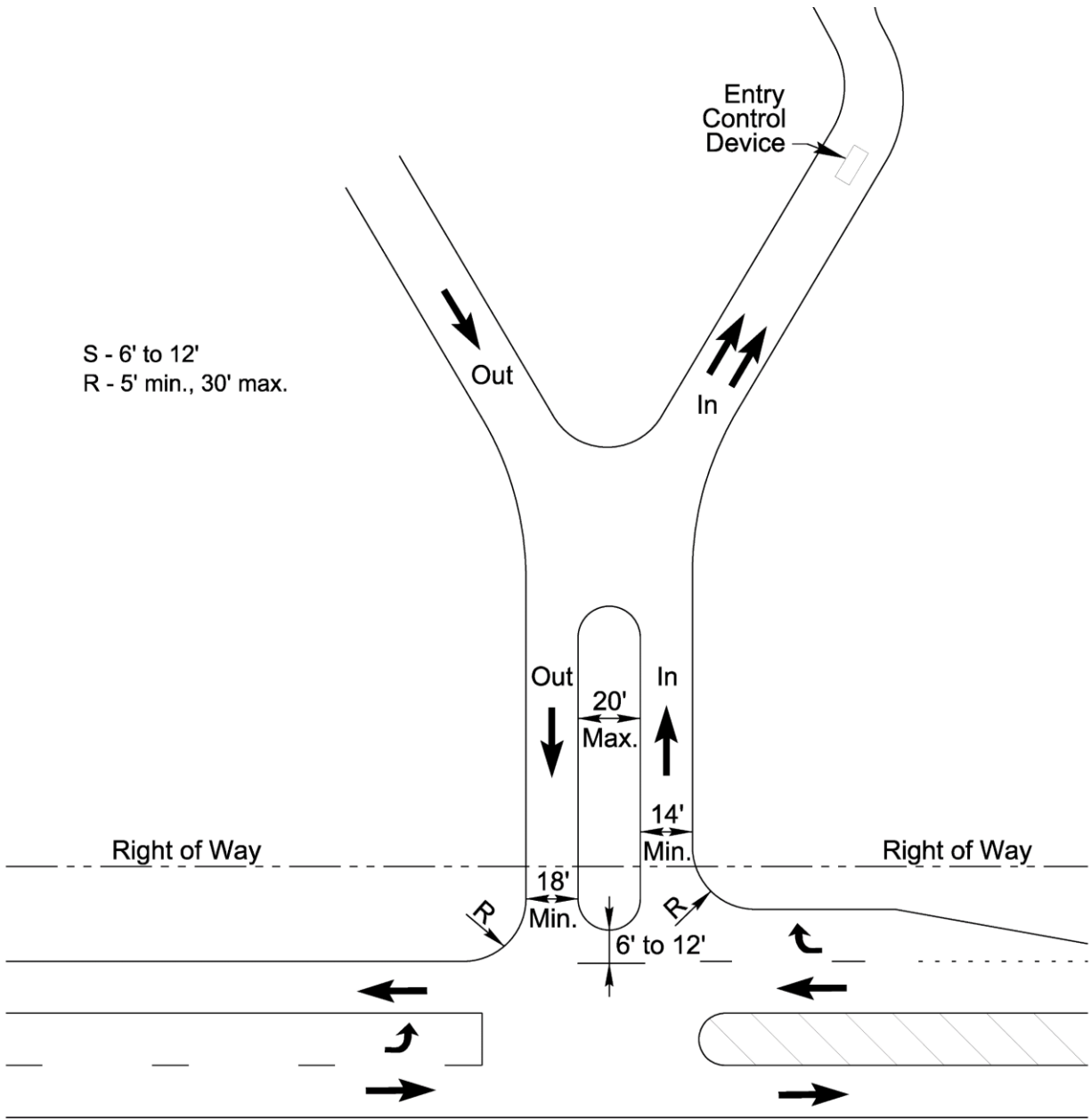

Note: Locate gates, ticket offices or other entry control devices to accommodate peak ingress traffic storage without spill back into the adjacent public street.

This page intentionally left blank.

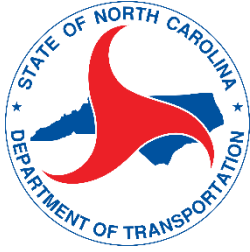

**North Carolina Department of Transportation  
Roadway Design Unit**

**Roadway Design Manual  
Part II Plan Preparation Procedures**

This page intentionally left blank.

## Part II Overview

Part II of this Roadway Design Manual (RDM) is primarily directed to the preparation of the roadway plans, specifications, and estimates. Most of the information is provided in narrative form. Illustrations are provided for some of the information which should be standardized in all roadway plans. However, to provide the roadway designer with some flexibility in plan preparation and still maintain reasonable conformity in the plans, specifications, and estimates; many chapters contain generic exhibits that provide examples of plan sheets. These exhibits were developed using the criteria and standards in force at the time of their creation and should not be used as a source for criteria unless specified as such within the section.

This manual provides design criteria in charts, tables, and illustrations. Because all the design concepts presented cannot be completely covered, references to additional literature will be provided for additional guidance. References to other North Carolina Department of Transportation (NCDOT or the Department) policies or other publications will be made for any design criteria not included in this manual in narrative or chart format. No references will be made to design practices believed to be common knowledge by well informed and experienced roadway designers. Due to the evolving nature of the Department's design and plan preparation processes, this document is considered a living document that will be continually edited and updated. If you notice incorrect or outdated information, or broken web links, please contact [NCDOT-RDM@ncdot.gov](mailto:NCDOT-RDM@ncdot.gov).

This page intentionally left blank.

# Chapter 11 Project Delivery

## 11.1 Introduction

NCDOT has developed business practices to withstand changes in workforce dynamics while serving North Carolina's transportation needs well into the future.

Integrated Project Delivery (IPD) is a culture where the Department promises what it is going to do and delivers what it promises. This approach improves project delivery with transparent, repeatable, and accountable processes that are effective and efficient.

Through IPD, NCDOT and our partners:

- make timely decisions regarding scope, schedule, budget, and quality,
- focus only on work processes and tasks that are required or will advance project objectives,
- improve communication, coordination, and decision-making, and
- hold ourselves accountable for how we deliver on our promises and serve our customers.

Refer to the [NCDOT Integrated Project Delivery](#) page of the Connect NCDOT website for more information concerning IPD and its current iteration.

## 11.2 Project Delivery Network

The [NCDOT Project Delivery Network](#) (PDN) provides consistency and transparency throughout the project delivery process, enabling project teams to improve reliability and efficiency. The PDN outlines the stages, activities, tasks, deliverables, and references to accomplish these ends. Specifically, the PDN is designed to assist technical team members, led by a Project Manager (whether a project is led by NCDOT or a private engineering firm), to realize the following:

- Maintain consistency via a logical progression of activities throughout the project initiation, environmental, and design phases.
- Streamline processes and procedures throughout the project development process.
- Identify team integration points to promote multidisciplinary collaboration at each stage of the process.
- Provide a systematic quality control (QC) and quality assurance (QA) process.
- Define key project deliverables and activities to build a schedule in Microsoft Project that the Project Manager and project team use to advance project delivery.

## 11.3 Quality Management Program

Quality management is an NCDOT best practice required on every project to ensure processes, products, and strategies meet or exceed the Department's expectations. The NCDOT Quality Management Program manual provides project managers and roadway designers with guidance on how to properly execute quality control (QC) and quality assurance (QA) activities for a project. The [NCDOT Quality Management Program manual](#) is available on the NCDOT Project Management site.



Project team members should review the manual as it outlines the roles and responsibilities of the project team. Quality control and quality assurance processes have also been developed to ensure the delivery of quality products.

The roadway design quality control subject matter expert reviews deliverables prior to submitting it to the designated NCDOT quality assurance auditor to ensure that all items on the QC checklist have been addressed. The NCDOT quality assurance auditor conducts a deficiency audit of the deliverables to confirm the QC procedures were performed correctly and that all deliverables comply with the appropriate policies, standards, and procedures. Complete checklists for the roadway design deliverables at each stage of the project. [The Roadway Design QC/QA checklists can be found on the Roadway Design Unit's website.](#)

# Chapter 12 General Plan Information

Plans are the media through which the designer communicates the design to the contractors. The designer’s mission is to be as clear and consistent as possible in communicating construction information on the plans. The designer is responsible for producing plan sheets that are accurate, neat, presentable, and reproduce legibly, which is critical to this mission. This chapter provides the designer with the policies and procedures to present design information on a set of roadway project plans. It also provides guidance on the electronic plan submittal process, the use of the Connect NCDOT SharePoint site, combined and clustered projects, public involvement mapping guidelines, location and design approval, and the roadway aesthetic review process.

## 12.1 Displaying Information and Data

Make the text and plan details legible from either the bottom or right edge of the plan sheet. The orientation of the text is as follows:

- horizontal line: read left to right
- vertical line: read bottom to top
- diagonals: read left to right

Tables 12-1 through 12-4 show the Department’s labeling precision preferences. Discuss deviations with the NCDOT project manager and roadway team lead.

**Table 12-1 Labeling Precision Preferences for Typical Sections**

Feature	Units	Precision	Example
Stations	FT	Hundredth	10+00.00
Dimensioning	FT	Whole, Tenth	12', 0.5'
	IN	Whole	6"
		Tenth	2.5"
Superelevation	FT/FT	Hundredth, Thousandth	0.02, 0.025
Side slopes	H:V	Whole:1	2:1
Pavement schedule	IN	Whole, Fractional, Tenth	3.5"
	FT-IN	Whole	2'-6"

Table 12-2 Labeling Precision Preferences for Plans

Feature	Units	Precision	Example		
Stations	FT	Hundredth	10+00.00		
Partial stations			+00.00		
Offsets			36.00'		
Dimensioning	FT	Whole, Tenth	12', 0.5'		
	FT-IN	Whole	2'-6"		
	IN		6"		
Superelevation	FT/FT	Hundredth, Thousandth	02, 025		
Bearings	DMS	Tenth of Second	N 23° 23'31.3" E		
Curve data:					
Central angle ( $\Delta$ )	DMS	Tenth of Second	23° 23'31.3"		
Degree of curve (D)					
Spiral angle ( $\theta_s$ )					
Length of curve (L)	FT	Hundredth	123.45'		
Tangent distance (T)					
Radius (R)					
Total length of spiral (Ls)					
Long tangent (LT)					
Short tangent (ST)					
Runoff (RO)				Whole	124'
Superelevation (SE)				FT/FT	Hundredth, Thousandth
Flares and tapers	L:W	Whole:1	50:1		
Traffic diagrams (ADT)	100	Hundreds	400		

Table 12-3 Labeling Precision Preferences for Profiles

Feature	Units	Precision	Example
Stations	FT	Hundredth	10+00.00
Dimensioning	FT	Whole, Tenth	12', 0.5'
	IN	Whole	6"
Elevations	FT	Hundredth	788.55'
Grades	FT/FT	Ten Thousandth	(+) 3.2657%
Length of vertical curve (VC)	FT	Ten Foot Intervals	460'
Rate of vertical curvature (K)	None	Whole	84

Table 12-4 Labeling Precision Preferences for Cross Sections

Feature	Units	Precision	Example
Stations	FT	Hundredth	10+00.00
Elevations			844.06
Dimensioning	FT	Whole, Tenth	12', 0.5'
	IN	Whole	6"
Superelevation	FT/FT	Hundredth, Thousandth	.02, .025
Side slopes	H:V	Whole:1	2:1

Apply the following rules for displaying information and data on roadway plan sheets:

1. Dimensioning requirements:
  - a. Show dimensions in feet and inches with an accompanying apostrophe (symbol for foot) and quotation mark (symbol for inch), e.g., 12', 0.5', 2'-6", 2½". Maintain consistency in the dimensioning throughout the roadway plans. Base the use of feet and decimals of a foot for dimensions versus the use of feet and inches on the bid item involved.
  - b. Show horizontal control points on plans, including survey centerline, intersections, and alignments in feet to two decimal places.
2. Stationing:
  - a. Base plan sheet stationing on 100 feet per station with full annotation at 500-foot stations (e.g., 15+00, 20+00).
  - b. Increase plan sheet stationing for mainline alignment from left to right (west to east) or from bottom to top (south to north).
  - c. Increase plan sheet stationing for -Y-line alignments from the top to the bottom of the sheet.
3. Vertical curve data:
  - a. Label design speed only when the vertical curve does not meet the design speed for the project.
  - b. Show profile grade in percent to four decimal places with the prefix (+) or (-) to indicate slope direction. In keeping with standard computer-aided design and drafting (CADD) practice, ensure that the vertical point of intersection elevation is rounded to the nearest hundredth of a foot.
4. Side slopes (typical sections and cross sections):
  - a. Express slope ratios in horizontal to vertical (H:V) format (e.g., 2:1, 4:1).
  - b. Show side slope ratios to the nearest tenth (e.g., 1.5:1) when deemed appropriate by the roadway designer.
5. Flares and tapers:
  - a. Express flares in a nondimensional ratio. The longitudinal component shown first and then the lateral offset component (e.g., 50:1, 15:1).
  - b. Express tapers as a dimension in feet (whole number) where feasible.

6. Line work:
  - a. Make a good, clear delineation of all lines so the proposed work will stand out in contrast to existing features. Use NCDOT's workspaces to ensure consistency in design and printing.
  - b. Do not place lines, hatching, or patterning through text or figures.

### 12.1.1 Lettering on Plans

Do not crowd other information when placing text on plan sheets. Carefully choose locations for text labels that are as close as possible to the point of application. Place text in a manner such that it is not upside down. Ensure text is in all caps and legible when the plan set is oriented with the binding on the left side of the plan set. Make text orientation consistent throughout the plans.

Use abbreviations on plan and profile sheets only where there is not enough space to spell out the word. Spell out words or use a legend for abbreviations in instances where the meaning of the abbreviation may be in doubt. Make all plan text legible at any standard printing scale.

### 12.1.2 Scale on Plans

For roadway plan sheets, a horizontal scale of 1 inch = 50 feet (NCDOT standard base scale) is generally used. A horizontal scale of 1 inch = 20 feet, 1 inch = 30 feet, or 1 inch = 40 feet can be used where greater detail is required and where existing topo is congested. Utilize a horizontal scale of 1 inch = 100 feet for projects on new location, in areas of very little topo, and for interchange sheets. Discuss the scale of the sheets with the Project Manager at the scoping meeting to ensure that proper surveys are requested through the Photogrammetry Unit and Location and Surveys Unit.

For roadway profile sheets, a scale of 1 inch = 50 feet (horizontal) and 1 inch = 10 feet (vertical) is commonly used. The horizontal scale on the profile sheet typically matches the horizontal scale of the plan sheet.

For most projects, cross sections are plotted on a horizontal and vertical scale of 1 inch = 10 feet. On mountainous projects with extremely high cuts and fills 1 inch = 20 feet might be more practical.

Adjust text size based on the drawing annotation scale in accordance with the [NCDOT Roadway Text Standard and Guideline](#).

## 12.2 Standard Sheets for Plan Preparation

Utilize standard sheets available from CADD for plan preparation. Plan border sheets and other standard cells are contained in the NCDOT workspace. Adhere strictly to their use to maintain conformity in plans prepared Department-wide. When deviation from the use of standard sheets is necessary, discuss this deviation with the NCDOT Project Manager and state contract officer.

All individual PDF sheets must be scaled 34 inches wide x 22 inches high. Submit full size cross section sheets (34 inches x 22 inches) when there are 30 cross section sheets or less. Submit half size cross section sheets (17 inches wide x 11 inches high) when there are more than 30 cross section sheets.

## 12.3—Electronic Plan Submittal

NCDOT has implemented an all-electronic process for letting. Turn in all submissions for design-bid-build projects with electronic signatures on documentation directly generated from electronic sources. Electronic plans submitted internally by units within the Department, as well as electronic plans submitted by private engineering firms or local government agencies to NCDOT, shall conform to the following specifications. The roadway designer is responsible for ensuring the plans and provisions that they submit electronically are signed and sealed (if appropriate) and follow all formatting guidelines as outlined.

### 12.3.1—Formatting Standards

Because files are managed, stored, and sorted electronically, perform file formatting, naming, and assignment of properties in a precise and consistent manner. Secure explicit approval from the NCDOT Project Manager and NCDOT Roadway Design Lead for deviations from the standards described. Submit all electronic plans in portable document format (PDF). Adhere to the following criteria when creating a PDF plan:

- Remove content that should not be included in the final sealed plan document.
- Include a cell image of the North Carolina Professional Engineer seal before creating the PDF plan document. Refer to North Carolina Administrative Code (NCAC) [21 NCAC 56 .1102](#) for specific information regarding the design of the seal.
- Ensure PDFs are printable at the appropriate scale. Must be either 34 inches x 22 inches or 17 inches x 11 inches in order to plot to scale. An interchange plan sheet may require a custom scale.
- Ensure PDFs are text searchable with default CADD layers.
- Ensure PDFs are landscape oriented (rotation 0 degrees).
- Provide an individual PDF file for each plan sheet.
- Generate all PDFs directly from the creating application, not by scanning.
- Ensure settings specified in the *Final Plans Best Practices* are followed when creating PDF files (link is accessible only with a valid NCID account).

### 12.3.2—Standard Filename Structure

File naming conventions are unique to each discipline. Include the sheet page number and Transportation Improvement Project (TIP) number along with some sort of description or classification to suggest the content of the file in the file name.

Refer to the *NCDOT Standard File Naming Conventions Guideline* for guidance for all NCDOT users and engineering consultant firms that produce roadway plans.

Use the naming standards and conventions for the various document sets to bundle plan sheets in the Final Plans library on the Preconstruction project team site on Connect NCDOT. Each discipline will have its own unique document set folder. Give file names a two-part numeric prefix when moving them to the Final Plans library. The first three digits are the same as the document set that contains the file (e.g., 100 roadway and 300 cross sections). The second three digits are the unique number for each sheet in proper sequence. The second 3-digit number is NOT the page number displayed on the sheet. Use increments of five (e.g., 001, 005,

010, etc.) for the second 3-digit number to allow additional sheets to be added if needed. Folder and file name numeric prefixes will control the let plan page order in the final plan set.

Refer to the quick reference for [NCDOT Final Plans and Special Provisions](#) for more detailed guidance (link is accessible only with a valid NCID account).

Download the plan file renaming tool from the [NCDOT CADD team site](#) to assist in sorting, sequencing, and formatting the numeric prefixes to the files.

### 12.3.3 — Electronic Signatures

The Department has implemented procedures for Professional Engineers to digitally seal and sign plans. Submit all plans electronically in a PDF format with digital signatures. DocuSign was chosen by NCDOT to provide digital signatures, but providers can use any recognized eSignature tool to sign documents.

The North Carolina Board of Examiners for Engineers and Surveyors recognizes electronically generated seals as an acceptable form of the professional seal. Seal electronic plans in accordance with Title 21, Section .1100 Chapter 56 of the NCAC.

Refer to [21 NCAC 56 .1101](#), [21 NCAC 56 .1102](#) and [21 NCAC 56 .1103](#) for more specific information regarding NCAC rules.

- ~~The seal may be a computer-generated seal or other facsimile that becomes a permanent addition to the plan sheet.~~
- ~~The licensee's signature must be placed over, or near, the seal on the original document.~~
- ~~The date of signing must be annotated on the original document.~~
- ~~All sheets of engineering and surveying drawings must be sealed.~~
- ~~A label stating "Document not considered final unless all signatures completed" must appear near the North Carolina Professional Engineer seals on all sheets that are to be sealed.~~

In addition to the information provided above, the following plan sheets typically require the indicated seals:

1. ~~Title Sheet — Roadway Design Engineer and Hydraulics Engineer.~~
2. ~~Sheet 1A — Roadway Design Engineer.~~
3. ~~Typical Sections — Roadway Design Engineer and Pavement Design Engineer.~~
4. ~~Roadway Detail Sheets — Roadway Design Engineer and Hydraulics Engineer (if applicable)~~
5. ~~Details from other Disciplines — Will be sealed by the Discipline Engineer.~~
6. ~~Plan and Profile Sheets — Roadway Design Engineer and Hydraulics Engineer.~~

## 12.4 **12.3** Connect NCDOT (SharePoint)

[Connect NCDOT](#) is an extranet website designed to service NCDOT and its business partners. The site houses information geared towards engineering firms, contractors, and other businesses that collaborate with the Department. Project and team sites are reserved for internal and external collaboration which require specific permissions to access.

Refer to the [NCDOT Preconstruction](#) team sites for preconstruction information for NCDOT highway and bridge projects (link is accessible only with a valid NCID account).

Refer to [NCDOT Preconstruction Best Practices](#) for instructions and guidelines for using the preconstruction application for sharing and exchanging project design documents between NCDOT and Professional Engineering Firms (link is accessible only with a valid NCID account).

[Refer to the quick reference for NCDOT Final Plans and Special Provisions for more detailed guidance \(link is accessible only with a valid NCID account\).](#)

### 12.3.1 Roadway Key Documents

Typical roadway key documents that should have the key RDY value set include, but are not limited to, the following:

- All approvals and denials
- Construction cost estimate
- Information related to any pending legal actions
- Correspondence providing historical or background information on controversial matters
- Justification studies for special or unusual matters
- Design exception approval
- Design decisions
- Location and design approval (LADA)
- Any other item that, in the judgment of the project manager or roadway designer, should be retained

## 12.5 ~~12.4~~ Combined and Clustered Projects

Typically, a project is advertised and let as an individual project, but in some cases two or more projects may be combined or clustered. There are various reasons to combine or cluster projects, which will be covered in detail in this section.

### 12.5.1 ~~12.4.1~~ Combining State Highway Projects

A combined project involves combining two or more individual projects into a project with a single construction Work Breakdown Structure (WBS) element. A combined project is treated as one project. Only one contractor is awarded the contract for the combined project. There is no limit to the types of projects that can be combined for advertisement and letting purposes. For example, combined projects can include two or more TIP projects or a TIP project and a resurfacing project. Some of the benefits of combining projects include:

- There is only one prime contractor, which simplifies contract administration.
- There is no cooperation of contractor clause needed when adjacent projects are combined.
- The construction phasing is typically less complex due to only a single prime contractor being involved in the projects.



If the distribution of final right of way plans has occurred on a part or the entire combined project, follow the guidance below when combining projects into a project with a single WBS construction element.

1. Organize the combined set of plans as follows:
  - a. Combined title sheet (Sheet No. 1)
  - b. Sheet 1A for combined set (Sheet 1A)
  - c. Conventional symbols for combined set (Sheet 2)
  - d. Part I plan set (with no 1A or 1B sheets)
  - e. Part II plan set (with no 1A or 1B sheets)
2. Title sheets:
  - a. (Sheet 1) Create a combined title sheet for the combined plan set. The combined title sheet is identical to the standard TIP project title sheet and should reference the following:
    - i. Show the contract number and all TIP or WBS element numbers on the left edge of the sheet for each project that is being combined.
    - ii. Create a project layout to show all the projects that are to be combined. Identify the project limits for each individual project on the project layout by TIP numbers and stations. Label each TIP number as a part (Part I, Part II, Part III, etc.)
    - iii. Reference a combined length of roadway, combined length of structure, and total combined project length on the combined title sheet.
    - iv. Include the following information in the project identification block in the top right corner of the combined title sheet:
      1. State Project Reference No. – List all TIP numbers. If there is no TIP number assigned to one or more of the projects, list the resurfacing project number or project identification number.
      2. State Project No. – List the P.E., right of way, utility, and construction WBS elements for all individual projects that are to be combined. There should be only one construction WBS element.
      3. F.A. Project No. – List the PE, right of way, utility, and construction F.A. numbers as applicable for each individual project.
      4. Description – In the rows for the description, list the PE, right of way, utility, or construction in parentheses for each associated WBS element.
  - b. Create a title sheet for each individual project plan set. These individual project title sheets are identical to the standard TIP project title sheet with the following exceptions.
    - i. No contract number will be referenced on the individual project title sheets. The combined title sheet is the only sheet on which the contract number is shown.
    - ii. There is only one construction WBS element for a combined project. The construction WBS element referenced in the title block in the upper right-hand corner of the combined title sheet and all individual title sheets should be identical.

3. (Sheet 1A) Index of Sheets, General Notes, and List of Roadway Standard Drawings:
  - a. A combined project will have only one 1A sheet. This 1A sheet will contain the following:
    - i. An Index of Sheets referencing all plan sheets of the combined plan package.
    - ii. The General Notes for all projects in the combined plan package.
    - iii. The 2018 Roadway English Standard Drawings for all projects in the combined plan package.
    - iv. Typically, only one 1A sheet will be needed. Use multiple 1A sheets if needed to ensure text sizes meet minimum tolerances.
4. (Sheet 2) Conventional Plan Sheet Symbols:
  - a. A combined project will have only one Conventional Plan Sheet Symbols sheet.

Place the individual parts (TIP projects, resurfacing projects) behind the combined project sheets. With few exceptions, each individual project is assembled as if it was an independent project rather than part of a combined project. The exceptions, as noted above, are that the individual parts do NOT require the Index of Sheets, Sheet 1A, and Conventional Plan Sheet Symbols sheet.

Differentiate the individual projects by labeling them as Part I, Part II, and so forth. Combine all pay item quantities from the individual projects into a single estimate since there is only one construction WBS element for the combined projects. Since each individual project will contain summary of quantity sheets specific to that project, consolidate the summary of quantity information in order to determine quantities for the combined estimate. List the summary sheet totals from other parts under the respective summary totals in the Part I plans. Add the totals and show a grand total.

Place plan submittals from other disciplines into Part I of the combined project, if necessary. For example, there may be only one set of transportation management plans (TMP) that covers all projects within the combined project package. In that case, place the TMP submittal package in the Part I plans.

Refer to the following links for an example of a combined project: [Part I](#) and [Part II](#).

### **12.5.2** **12.4.2** **Clustered State Highway Projects**

A clustered project involves advertising and letting two or more projects together. Do not treat clustered projects as combined projects; each individual project is treated as its own project and never combined. One or multiple contractors could be awarded the contract for a clustered project. The primary benefit of clustering projects is to keep construction costs as low as possible. Contractors can bid on the clustered project as a whole and bid on the individual parts. If a contractor's bid for the clustered project is less than the lowest bid price for each of the individual projects, that contractor will typically be awarded the contract. If the sum of the lowest bids for each of the individual projects is less than the lowest total cost for the clustered project, the clustered project will be awarded to the contractors with the lowest individual bids.

Prepare a clustered earthwork balance sheet for the clustered project in addition to the individual earthwork balance sheets for the individual projects. This clustered earthwork balance sheet combines the earthwork from the individual projects into one earthwork balance sheet. Confirm that the construction phasing will allow suitable waste material from one project to be

incorporated into the other clustered project when preparing the clustered earthwork balance sheet.

The earthwork summaries in each of the individual projects are not affected. The only requirement is to prepare a clustered earthwork balance sheet. For example, when two projects are clustered (Project A and Project B), three earthwork balance sheets need to be prepared: one for Project A, one for Project B, and one for the clustered project.

Refer to [Earthwork Balance Sheet](#) for an example of a clustered project earthwork balance sheet.

## ~~12.6~~12.5 Public Involvement Mapping Guidelines

Public involvement is a critical component of the transportation decision making process. Public involvement allows citizens the opportunity to provide opinions, insights, and observations that can improve the design and potentially accelerate project delivery. The Roadway Design Unit and its consultant partners will coordinate with the Public Involvement Team to develop any public involvement mapping that is required during project development. Some of the outcomes of this coordination include:

- A description of the standard mapping products and when they should be used
- Best practices for the development of these products
- Checklists to assist those who are producing and reviewing corridor public hearing maps and designing public meeting/hearing maps

The Department has developed a *NCDOT Statewide Public Involvement Plan* to provide public involvement guidance to ensure quality, consistency, and compliance throughout all NCDOT public involvement efforts. The Department has also developed a [NCDOT Public Involvement Map Information Guide](#) to capture the mapping needs for a project. The Roadway Design Unit and our consultant partners are responsible for preparing Corridor Public Hearing Maps and Design Public Meeting/Hearing Maps.

### ~~12.6.1~~12.5.1 Corridor Public Hearing Maps

Corridor public hearing maps are used to solicit feedback from the public on the corridors being studied, the alternatives being studied within the corridor, and the impacts associated with each. Therefore, all corridors should reflect a design that avoids and minimizes impacts to the extent practicable. The primary focus of the corridor public hearing map is not only the design details and how individual property owners are affected, but also how each studied highway corridor benefits and affects the region from a transportation perspective. Generally, a Corridor Public Hearing is held after the completion of the draft environmental document.

The Corridor Public Hearing Map consists of multiple corridor bands that include certain minimal design features as defined in the [NCDOT Public Involvement Map Information Guide](#).

[The Roadway Design QC/QA checklists can be found on the Roadway Design Unit's website.](#)

### ~~12.6.2~~12.5.2 Design Public Meeting/Hearing Maps

A Design Public Meeting/Hearing Map is used to solicit feedback from the public on the proposed design and the associated impacts that will be further developed into the final plans.

Refer to the [NCDOT Public Involvement Map Information Guide](#) for additional guidance regarding the development of Design Public Meeting/Hearing Maps.

[The Roadway Design QC/QA checklists can be found on the Roadway Design Unit's website.](#)

## 12.7 12.6 Location and Design Approval

Location and Design Approval (LADA) is a trigger document for obtaining right of way authorization, which is required for the release of the right of way funds. The LADA's purpose is to ensure the location and scope of work for the project found in the environmental document agree with the project plans, including any necessary environmental commitments. LADA letters are required for all Environmental Impact Statement and Environmental Assessment projects. LADA letters are not required for Minimum Criteria Determination Checklist, Programmatic Categorical Exclusion, or Categorical Exclusion projects. Design-Build projects will conduct their own consistency review and supply the materials to the Roadway Design Unit service account for DocuSign processing of the LADA letter.

The process involves a consistency review of the environmental document and the project plans at least two months prior the project right of way date. To begin this review, the Project Manager will ensure the final environmental document and latest project plans are available on the Preconstruction project site on Connect NCDOT. For centrally managed projects, send an e-mail to the Roadway Design Development & Support group team lead requesting location and design approval. Notify the Project Manager if any discrepancies are found during the consistency review. The Project Manager will need to resolve the irregularities with the planner and designer and notify the Roadway Design Unit.

Upon resolution, the LADA letter will be prepared and submitted by the Roadway Design Unit through a DocuSign process, requiring signatures from the State Roadway Design Engineer and Director of Technical Services for centrally managed projects. Highway Division offices may also conduct their own consistency review, led by the Division Project Manager and approved by the Division Engineer. The approved LADA letter will be placed on the preconstruction project site in the Roadway Design–Discipline, Correspondence–RDY Topic, Approvals–Location.

## 12.8 12.7 Roadway Aesthetics Review Process

Project managers may receive requests for aesthetic treatments (usually from a municipality). Address these requests as early in the project development process as possible so that the necessary agreements can be secured to make sure design adjustments, special details, and provisions can be included in final plans.

Most aesthetic requests take the form of a betterment to an already proposed design feature such as stamped or colored retaining walls, crosswalks, or roundabout aprons, decorative bridge rails (which may include lighting), and fencing or guardrail coloring options. In these instances, the project manager will need to coordinate the selection from available options with the requesting party and secure the necessary maintenance and cost share agreements before the treatments are included in the project plans and specifications.

Some aesthetic requests take the form of public artwork to be placed on NCDOT right of way. This can occur during an active project or under a standard encroachment agreement with the Division/District. The Department has a formal review and approval procedure for these instances, detailed in the [North Carolina Public Art on the Right of Way Policy](#). A Right of Way Art Committee, consisting of units designated by the Secretary of Transportation, is responsible for reviewing and approving art proposals. The [Aesthetic Engineering Section Supervisor](#) typically administers this process, submitting aesthetic reviews to the committee members and coordinating communication with the requesting municipality.

The Roadway Design Unit has a representative on this committee. The typical roadway design review will evaluate the proposal in terms of (but not limited to): sight distance, clear zone requirements, pedestrian passage, vertical and horizontal clearances, and breakaway aspects of the art installation. Contact the [Lighting and Electrical Team Lead](#) in the Roadway Design Unit when the art feature involves lighting and electrical features.

Local government and municipal signs or gateway signs are not covered under the North Carolina Public Art on the Right of Way Policy, and are addressed under *the [NCDOT Standard Practice for Gateway Signs](#)* and the [NCDOT Traffic Engineering Policies, Practices, and Legal Authority \(TEPPL\)](#). Coordinate gateway signs with [NCDOT Signing and Delineation](#).

This page intentionally left blank.

# Chapter 13 Plan Preparation

## 13.1 Introduction

The development of roadway plans is the primary responsibility of the roadway designer. The completed roadway plans consist of the following basic information: a title sheet showing the general type of work planned and the project location, typical sections for roadways to be constructed, the horizontal and vertical alignments, the proposed drainage pipes, ditches, structures, and the proposed right of way necessary for roadway construction. Also included are basic summaries such as earthwork, guardrail, and pavement removal. A complete set of roadway plans typically consist of, but are not limited to, the following:

- Title sheet
- Index of sheets, general notes, and list of roadway standard drawings
- Symbology sheet
- Typical sections
- Detail sheets
- Summary of quantities and parcel index sheets
- Plan and profile sheets
- Cross section sheets

Complete and accurate final roadway plans are necessary to ensure highway construction projects are contracted in an economical and efficient manner. The roadway plans need to be detailed enough to provide prospective contractors with the information to accurately bid and construct the project. Omissions and errors in the plans may lead to project delays and cost overruns; therefore, it is critical the roadway designer submit complete and accurate plans at all phases of plan development.

This chapter provides detailed information pertaining to the preparation of the various items which comprise a completed set of roadway plans. Guidelines and examples are provided to aid the designer in the preparation of the roadway plans during all phases of project development. Consult the plan development checklists when preparing the roadway plans at the various stages of project development. Unless noted within each individual section, the information specified refers to plans developed during and after Stage 2 (Alignment Defined) of the [NCDOT Project Delivery Network](#) (PDN). Complete the appropriate quality assurance (QA) or quality control (QC) checklist for the activity being performed.

Detailed information regarding content of the various sheets that comprise the roadway plan package is listed in the [NCDOT Review List for Final Construction Plans](#). Templates for NCDOT sheeting are found in the NCDOT workspace.

Refer to [NCDOT Example Roadway Plan Set \(Title Sheet through Profile Sheets\)](#).

## 13.2 Title Sheet

The title sheet is the first sheet of the assembled roadway plan package and serves to identify the location and limits of the project to aid in locating the project in the field. This sheet describes the project, lists the project identification numbers, and provides information related to

the project location, project length, and type of work. Some of the components that comprise a completed title sheet are covered in detail below.

The information that is typically listed on a title sheet include:

- Project identification numbers
- County name(s)
- Location and type of work
- Vicinity map
- Project layout
- Scale
- Design data information
- Project length
- Roadway and hydraulics engineer's seals
- NCDOT contact (if applicable)
- Standard specifications for roads and structures.
- Right of way date
- Letting date
- Firm logo with firm name, address and license number (if applicable)
- Sheet number for the title sheet is 1 (leave Total Sheets blank)

### 13.2.1 Project Identification Numbers

The project identification number is a unique number used to identify each individual project within the NCDOT. This project identification number will typically be a Transportation Improvement Program (TIP) number, but other project identification numbers can also be specified.

Work Breakdown Structure) (WBS) elements are used to identify funding for the project. For NCDOT personnel, the WBS elements will be provided by the NCDOT Project Manager and can be found by accessing the TIP Project Information (ZPSR25) on the North Carolina Enterprise Business Services portal (link is accessible only with a valid NCID account). NCDOT partners at private engineering firms will need to obtain the WBS elements from the NCDOT Project Manager. Typically, there will be three WBS elements referenced on a title sheet.

- PE (Preliminary Engineering)
- RW, UTIL. (Right of Way and Utility Relocation)
- CONST. (Construction)

In some cases, there may be individual or more than one RW and UTIL WBS elements for a project.

When the project involves federal funds, reference the Federal Aid Number on the title sheet.

For centrally let projects, a contract number (or contract ID) will be assigned by the Estimating Management Section in the Contract Standards and Development Unit when the project is



added to the 13-Month Let List. On Division managed projects, the contract number will be assigned by the Division project development staff. Include a contract number and TIP number on the left-hand margin of the title sheet. Reference the contract number on the cover sheet of the proposal during advertisement for use by the Construction Unit and contractor to identify the project during construction.

### 13.2.2 Location and Type of Work

The location of the project and type of work is used repeatedly on various engineering documents throughout the project development process. In the preparation of various project documents, the space available for writing this information is limited. Keep the descriptions for the location and type of work to an absolute minimum.

In describing the location, limit the information to the county or counties, route (Interstate, US, NC, or SR), and the begin and end points of the mainline (-L-) project. Ensure the location and type of work information on the title sheet correspond to the description and type of work listed on the [NCDOT 12 Month Let List](#).

Limit the information listed in the type of work to the major types of construction. The major types of work include but are not limited to the following: grading, paving, drainage, structure (if the project has a bridge and culvert (if applicable)), culvert (if the only structure on the project is a culvert) and widening (if the project involves the widening of the mainline). Signals, signing, and pavement markings are not typically considered major types of work unless the project is only adding signals, signing, or pavement markings without improving other major types of construction.

### 13.2.3 Vicinity Map

A vicinity map is required to show sufficient identifying information so the project may be easily located on a county or state map. The vicinity map is not to scale. Clearly show the major transportation routes (Interstate, US, NC, SR) that can be used for transporting construction materials to the project site. Show the begin and end points of the project on the vicinity map except for bridge replacement projects. On bridge replacement projects a circle can be used to represent the project limits in lieu of labeling the begin and end points. Include a vicinity map with the following information when applicable:

- City and city limits
- Interstate, US, NC, and state routes
- North arrow (oriented towards the top of the title sheet)
- Beginning and end of project
- Vicinity map title block
- Offsite detours

### 13.2.4 Project Layout

The project layout is a small-scale drawing of each plan sheet that is displayed on the center of the title sheet. The sheet number is shown on each superimposed plan sheet on the project layout. This provides a quick reference to a specific location in the plans. Include on the project layout all interchanges, intersection, service roads, structures (bridges and culverts), railroads, outstanding geographical features, and any other major landmarks that may be used as a reference point. The project layout will include the following information when applicable:

- Shade areas to show proposed limits of construction (-L- lines, -Y- lines, service roads, detours, etc.)
- Existing roads to be affected by construction, but not a part of the project
- Route numbers (Interstate, US, NC, SR), survey line numbers, and street names.
- Symbols for proposed bridges and culverts (culverts 20 feet and greater in width) with begin and end stations
- Streams and rivers
- Railroads
- City limits.
- State and county limits
- Begin and end stations for each project
- Begin and end construction stations outside of the project limits
  - Begin or end construction labels are not required for minor -Y- line constructions on title sheet; however, it should be referenced on applicable plan sheet
- Destination points/arrows at the begin and end of the project
- North arrow (showing correct state plane grid coordinates)
- Existing and proposed traffic signals (Title Sheet and Plan Sheet)
  - Existing traffic signals denoted with a hollow star
  - Proposed traffic signals denoted with a solid star

The begin and end project stations represent the limits of the project determined at the early stages of plan development. The begin and end construction limits are needed if any work is being performed outside of the begin or end project limits. Reference the begin and end project stations and begin and end construction stations on the title sheet and applicable plan sheets.

### 13.2.5 Scale

Display the scale of the plan and profile sheets on the title sheet.

Refer to RDM Part II Chapter 12 Section 12.1 for additional information pertaining to scale.

### 13.2.6 Design Data

The design data or design controls are the criteria used to optimize or improve the design. The design data is a list of specific design criteria used in the design of the project.

Show information related to design as follows:

- |     |          |   |  |
|-----|----------|---|--|
| (1) | ADT 2021 | = | 25,000 (LET year)                          |
| (2) | ADT 2041 | = | 60,000 (Design year = LET year + 20 years) |
| (3) | K        | = | 12%  |
| (4) | D        | = | 60%  |
| (5) | T        | = | 11% (5% TTST and 6% DUAL)                  |
| (6) | V        | = | 60 MPH                                     |

Where:

(1)	Average daily traffic (ADT)	Given for the year that the project is let to construction.
(2)	Average daily traffic (ADT)	Given for the design year. The design year should be twenty years from the letting date.
(3)	K	Give as a percentage for design hourly factor.
(4)	Peak hour directional split (D)	Percentage of DHV traveling in the direction of major flow.
(5)	Percent of ADT that is trucks	Truck, tractor, and semi-trailer (TTST) are multi-unit trucks including both single and twin-trailer rigs. Duals are trucks with at least one dual tired axle.
(6)	V	Design speed

Reference the functional classification of the mainline and the hydraulic tier with the design data. Obtain the functional classification through the [GO!NC Portal](#). The NCDOT tiers can be determined using the guidelines below. Coordinate with the project team to confirm the appropriate tier is selected.

- Statewide Tier: All interstate and US routes on strategic highway corridors.
- Regional Tier: US and NC routes not on strategic highway corridors and SR routes classified as arterials or major collectors.
- Subregional Tier: SR routes classified as minor collectors and local roads..

### 13.2.7 Length of Project

The length of project is broken into roadway lengths and structure lengths of the mainline alignment. Compute separate lengths for the federal aid portion of any project. Base the structure length on the proposed new bridges and culverts. When a new box culvert or culvert extension is at least 20 feet wide, it is considered a structure when the length of the project is computed. Always show the length of project to three decimal places. When the fourth digit is five and above, round the third digit up. If equalities are present on the horizontal alignment, add the line ahead length to the line back length to determine the project length. This corresponds with the Structure Management Unit's method of computing structure lengths.

Examples of computing project lengths are shown below. When other conditions are experienced, discuss them with the [State Plans and Standards Engineer](#) in the Contract Standards and Development Unit.

#### 13.2.7.1 Project (with structures)

- Length of Roadway TIP Project R-99A = 4.205 Miles
- Length of Structure TIP Project R-99A = 0.038 Mile
- Total Length TIP Project R-99A = 4.243 Miles

#### 13.2.7.2 Project (without structures)

- Length of Roadway TIP Project R-99A = 4.205 Miles

- Total Length of TIP Project R-99A = 4.205 Miles

#### 13.2.7.3 Combined Project (with structures)

- Length of Roadway TIP Project R-99A/R-99B = 7.708 Miles
- Length of Structure TIP Project R-99A/R-99B = 0.094 Mile
- Total Length TIP Project R-99A/R-99B = 7.802 Miles

#### 13.2.7.4 Combined Project (without structures)

- Length of Roadway TIP Project R-99A/R-99B = 7.708 Miles
- Total Length TIP Project R-99A/R-99B = 7.708 Miles

#### 13.2.7.5 Combined Federal-Aid and State Project (I-303 & U-83)

- Length of Roadway TIP Project I-303 = 3.210 Miles
- Length of Structure TIP Project I-303 = 0.044 Mile
- Total Length TIP Project I-303 = 3.254 Miles
- Length of Roadway TIP Project U-83 = 0.723 Miles
- Length of Structure TIP Project U-83 = 0.022 Mile
- Total Length TIP Project U-83 = 0.745 Mile
- Total Length TIP Project I-303/U-83 = 3.999 Miles

### 13.2.8 Roadway and Hydraulics Engineer's Seal

The roadway designer is responsible for obtaining the Roadway Design Engineer's seal and the Hydraulics Engineer's seal for the title sheet. Construction revisions may require additional professional engineering seals if the original roadway or hydraulics engineer are not available to perform the revisions.

Refer to [21 NCAC 56.1103](#) Standard Certification Requirements for additional information regarding the NCAC requirements.

### 13.2.9 Firm Logo and Contact Information

Reference the logo of the engineering firm and the names of the NCDOT and firm contacts on the title sheet.

### 13.2.10 Title Sheet Notes

Add the following notes to the title sheet of the Right of Way Plan Set or Contract Roadway Design Plans, as needed.

- Method of Clearing Note (Remove from Contract Roadway Design Plans)
- Municipal Boundaries Note (~~Remove from Contract Roadway Design Plans~~)
- Control of Access Note
- Design Exception Note

- PDN submittal name based on the deliverable at the stage of project development (Stage 1 (Project Initiation), Stage 2 (Alignment Defined), etc.)

### 13.2.10.1 Method of Clearing Note

Show the method of clearing note on the Right of Way Plan Set (3RD1 of the PDN) but remove from the Contract Roadway Design Plans (4RD1 of the PDN). The preferred method of clearing will be provided by the Division Construction Engineer at the Field Inspection. The location of the project is the driving factor for determining the appropriate method of clearing. Factors such as urban vs. rural, environmental conditions, and permitting play a role in determining which method of clearing will be specified.

Refer to [NCDOT Roadway Standard Drawings](#) Std. Nos. 200.02 and 200.03 for additional guidance on the methods of clearing.

The standard method of clearing notes are as follows:

“Clearing on this project shall be performed to the limits established by Method II.”

or

“Clearing on this project shall be performed to the limits established by Method III.”

It is possible that both methods of clearing can be specified on an individual project or combined project. In that case, modify the notes to specify which alignments will require the specific method of clearing. There are also instances where a hybrid approach (i.e., Type II modified) will be specified. In that case, modify the note accordingly and obtain a detail sheet of the modified method of clearing from the [State Plans and Standards Engineer](#).

### 13.2.10.2 Municipal Boundaries Note

Show one of the following notes on the Right of Way Plan Set when the project or a portion of the project is within the limits of a local government. ~~Remove the municipal boundary notes from the Contract Roadway Design Plans (4RD1 of the PDN).~~

“This project is within the municipal boundaries of Town or City.”

or

“A portion of this project is within the municipal boundaries of Town or City.”

### 13.2.10.3 Control of Access Note

Add a note to the plans for projects that have control of access right of way. The applicable control of access note listed in the bullets below is required on the title sheet of the contract roadway design plans. There are three general types of control of access that may need to be referenced in the note.

- Full Control of Access: Connections to a facility provided only via ramps at interchanges. No private driveway connections allowed. For full control of access right of way, use the following note:

“This is a controlled access project with access being limited to interchanges.”

- Limited Control of Access: Connections to a facility provided only via ramps at interchanges (major crossings) and at-grade intersections (minor crossings and services roads). No private driveway connections allowed. For limited control of access right of way use the following note:

“This is a limited controlled access project with access being limited to interchanges and at-grade intersections.”

- **Partial Control of Access:** Connections to a facility provided via ramps at interchanges, at-grade intersections, and private driveways. Private driveway connections are normally defined as a maximum of one connection per parcel. One connection is defined as one ingress and one egress point. The use of shared or consolidated connections is highly encouraged. For partial control of access right of way use the following note:

“This is a partial controlled access project with access being limited to points shown on the plans.”

Refer to RDM Part II Chapter 14 Section 14.2 for control of access definitions and additional guidance pertaining to control of access and right of way.

## 13.3 Index of Sheets, General Notes, and List of Roadway Standard Drawings

Reference the index of sheets, general notes, and list of roadway standard drawings on plan sheet 1A which is placed directly behind the title sheet. Include the roadway designer’s seal on sheet 1A.

### 13.3.1 Index of Sheets

The index of sheets acts as the table of contents of the construction plan package which includes the roadway and structure plans. The order of the plan sheets has been standardized to make it easier to locate individual plan sheets in the construction plans. The index of sheets should be placed on the left side of the 1A sheet. The final plan sheet arrangement for the index of sheets is listed in Table 13-1. Other discipline plan sets that may be unique to the project can be added to the list as needed.

**Table 13-1 Final Plan Sheet Arrangement Index of Sheets**

Sheet Number	Sheet Description
1	Title Sheet
1A	Index of Sheets, General Notes and List of Standard Drawings
1B	Conventional Symbols
2A-Series	Pavement Schedule and Typical Sections
2B-Series	Roadway Details (produced by roadway personnel)
2C-Series	Details not covered by roadway (special details produced by the State Plans and Standards Engineer)
2D-Series	Drainage Details
2G-Series	Geotechnical Details
2H-Series	Geoenvironmental Details
2N-Series	Noise Wall Envelopes
3B-Series	Roadway Summaries (earthwork, guardrail, etc.)
3D-Series	Drainage Summaries
3G-Series	Geotechnical Summaries
3P-Series	Parcel Index Sheets
4	The first plan sheet will always be number 4; all other plan and profile sheets shall be numbered to fit the project conditions.

Sheet Number	Sheet Description
RW-Series	Survey Control, existing centerlines, right of way, easement, and property ties
TMP-Series	Transportation Management Plans
PMP-Series	Pavement Marking Plans
E-Series	Electrical Plans
EC-Series	Erosion Control Plans
<u>OSM-Series</u>	<u>On-Site Mitigation Plans</u>
RF-Series	Reforestation Plans
<del>NS-Series</del>	<del>Natural Stream Restoration Plans</del>
LS-Series	Landscape Plans
SIGN-Series	Signing Plans
SIG-Series	Signal Plans
ITS-Series	ITS Plans
UC-Series	Utility Construction Plans
UO-Series	Utility by Others Plans
X-1	Cross Section Index (when there are more than two alignments)
X-1A, X-1B, etc.)	Cross Section Summary (number as X-1 if there is no Cross Section Index)
X-2, X-3, etc.	Cross Sections
W-Series	Wall Plans <sup>3</sup> (if placed in roadway plan set)
S-Series	Structure Plans
C-Series	Culvert Plans
W-Series	Wall Plans <sup>3</sup> (if placed in structure plan set)

## Notes:

1. Do not show total sheet numbers on the plans.
2. For series sheets, example of sheet numbering is 2A-1, 2A-2, 2A-3, etc.
3. Wall plans are typically a part of the structure plan package, but if there are no structure plans (bridge or culvert), the retaining wall plans will be included as part of the roadway plan set.

### 13.3.2 General Notes

General notes are referenced on Sheet 1A and provide clarification to the plans. The general notes provide additional information that the roadway designer feels are necessary to correctly understand the intent of the design. The general notes apply to the contents of the roadway plans as a whole, as opposed to applying to individual plan sheets.

Refer to the [NCDOT Contract Standards and Development Unit](#) website to download a Microsoft Excel file containing the standard roadway general notes.

It is the responsibility of the roadway designer to denote the general notes pertinent to the project and include additional notes which do not appear in the standardized list of general notes when deemed appropriate. Many of the general notes reference standard drawings or are fill in the blank. Take care to ensure the correct information is referenced in the general notes. Show only general notes relative to the project. Any questions pertaining to the general notes should be directed to the [State Plans and Standards Engineer](#) in the Contracts Standards and Development Unit.



### 13.3.3 List of Roadway Standard Drawings

Reference a list of roadway standard drawings that are applicable to the project on Sheet 1A. The standard drawings are intended to support the engineering processes for construction operations and ensure the application of uniform standards in design and construction. It is important that the roadway designer be familiar with the NCDOT Roadway Standard Drawings before selecting a standard drawing for inclusion in the list. The NCDOT Roadway Standard Drawings are updated periodically, and some standard drawings may be replaced by details in lieu of standards. When needed, insert the details in lieu of standards in the plan set as a 2C-Series detail sheet. When a detail in lieu of standards is added, the detail may replace the applicable roadway standard drawing in the list or apply to specific sheets in the standard drawing. If the detail in lieu of standard replaces all the sheets in the applicable roadway standard drawing, do not reference the standard drawing in the plans. Any questions pertaining to the List of Roadway Standard Drawings and details in lieu of standards should be directed to the [State Plans and Standards Engineer](#) in the Contracts Standards and Development Unit.

Refer to the most current [NCDOT Roadway Standard Drawings](#) website for additional information pertaining to the standard drawings and details in lieu of standards.

## 13.4 Conventional Symbols

On a set of roadway plans, the objects are depicted by symbols, not by names. The symbols are used to mark necessary objects and features on the plans. Conventional symbols include, but are not limited to, the following:

- Boundaries and property lines
- Buildings
- Drainage features
- Railroads
- Right of way
- Roads and related features
- Existing and proposed structures
- Utilities

Include the conventional plan sheet symbols in the roadway plans as sheet 1B. A standard conventional plan sheet symbols cell has been created to standardize the conventional symbols used when preparing NCDOT plans.

Add a legend to the applicable plan sheet for any new symbols that are not included in the standard conventional symbols.

## 13.5 Typical Sections and Pavement Schedule

### 13.5.1 Typical Sections

A typical section is a cross sectional representation of the proposed roadway showing grading and paving details. Include all elements necessary to construct the roadbed, typical ditches, and pavement structure in the typical sections. The crown point and grade point are often at the same location on a typical section. A “crown point” is the highest point about which the superelevation rotates and ensures proper drainage. A “grade point” is the location where the



proposed profile grade or resurfacing grade is applied. A proposed crown point can be used in conjunction with a grade point at different locations to optimize drainage systems. See Figure 13-1 for an example application. A crown point on its own is used on minimum depth resurfacing and widening projects that follow existing grade.

**Figure 13-1 Crown Point and Grade Point on a Typical Section**

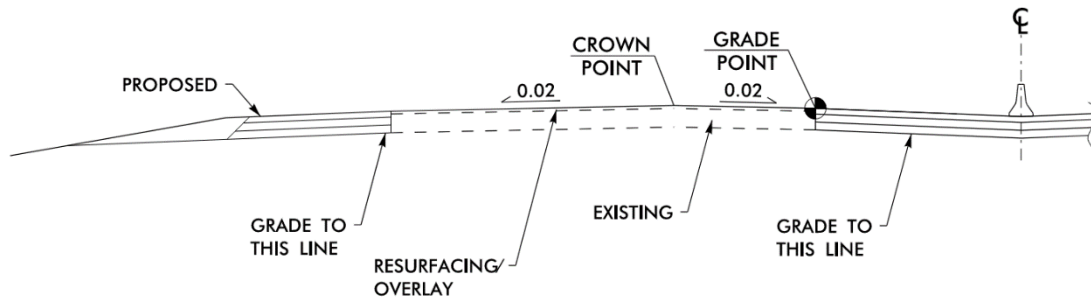

Draw typical sections for each different pavement design and for major variations in the component widths. Use partial typical sections or insets with notes for minor variations to minimize the number of typical sections required. Make a conscious effort to minimize the number of typical sections. The use of a single typical section to represent multiple alignments is encouraged. Use tables to denote the variations in dimension widths and pavement codes.

Refer to the [Example Typical Section Sheets](#) provided by NCDOT.

- Typical sections or partial typical sections are not needed for auxiliary lanes or tapers. When typical sections cover a length of roadway that is typically of uniform width, do not put variable dimensions to cover turning lanes, tapers, etc. The plans will cover these variations.
- Show a normal crown (0.02) as typical unless the project warrants a 0.025 pavement cross slope.
- Typical sections are not needed to cover superelevation unless there are no normal crown conditions on the segment of the roadway for which the typical section applies.
- If all ramps have the same pavement design, use a single typical section to cover all ramps by labeling “reverse” on the individual ramp listing.
- Ensure the stations shown on the typical sections agree with the stations shown on the title sheet and plan sheets.
- Show monolithic islands, concrete barrier (single or double faced), and retaining walls when they comprise a significant portion of the typical section. Insets or partial typical sections may also be used to cover these features.
- Narrow widening is any widening less than 6 feet in width. Note that narrow widening is also applicable to paved shoulders. When the pavement design references a narrow widening pavement design for any alignment, clearly denote on the typical sections all areas that will require the narrow widening pavement design. An inset may be used to denote and clarify the areas of narrow widening.

- Organize or group typical sections on the typical section sheets in sequential order as they appear on the plan sheets.
- Provide typical sections for bridges on plans. Include a note to see structure plans for construction.
- Typical sections under the bridges are not required once Preliminary General Drawings are approved.
- Typical sections should differentiate between sidewalk and sidepaths or shared-use paths. Sidepaths and shared-use paths may require a pavement design that differs from standard 4-inch-thick sidewalk.
- An inset (CADD cell library) for the typical section has been created for placement on projects that require aggregate stabilized or chemically stabilized subgrades. The inset lists station ranges and shallow undercut thickness recommended from the Geotechnical Recommendations for Design and Construction. The letter codes for the Pavement Schedule include Chemical Stabilization (K1), Class IV Subgrade Stabilization (K2) and Geotextile for Subgrade Stabilization (N1).

### 13.5.1.1 Limits of Use

Include on each typical section, a listing of the locations where it applies. Designate these locations by a survey line and station limits. Break station to station limits at the begin and end of the bridge (not the approach slabs). Also break stations for equalities, when applicable.

### 13.5.1.2 Dimensions

Show dimensions for all typical section elements. Show horizontal dimensions in feet, tenths of a foot, or inches, typically to the nearest foot. Limit dimensions to those required to clearly explain the intent of the typical section.

Refer to RDM Part II Chapter 12 Section 12.1 for more detail on displaying information and data.

## 13.5.2 Pavement Schedule

For centrally managed projects, request and receive the Pavement Design from the [State Pavement Design Engineer](#) at the PDN Stage 2 (Alignment Defined). Incorporate the Pavement Design into the full and partial pavement schedules on the typical section sheets.

Refer to the [NCDOT Project Delivery Network](#) (PDN) for when to request and incorporate the pavement designs. The Division Project Manager has the option to request a pavement design from the State Pavement Design Engineer or develop their own pavement design. The engineer who developed the pavement design will seal the typical sections.

Show a full pavement schedule on the first typical section sheet and include a code and a description for all elements of the various pavement designs applicable to the project. Show an abbreviated pavement schedule on the remaining typical section sheets for ease of reference. Use the code letters shown in Table 13-2 in pavement schedule.

**Table 13-2 Code Letters for Pavement Schedule**

Code Letter	Item
A	Portland cement concrete pavement

Code Letter	Item
B	Open-graded asphalt friction course, Type FC
C	Asphalt concrete surface course, Type S
D	Asphalt concrete intermediate course, Type I
E	Asphalt concrete base course, Type B
F	Asphalt surface treatment
G	Cement treated base course
J	Aggregate base course
K	Stabilized subgrade
L	Stabilizer aggregate
M	Soil type base course
N	Geotextile
P	Prime coat
R	Combination concrete curb and gutter Concrete curb 5" Monolithic concrete island Concrete island cover
S	Concrete sidewalk
S1	Sidepath or Shared-use path
T	Earth material
U	Existing pavement
V	Milling, incidental milling, or as needed
W	Variable depth asphalt pavement (See Standard Wedge Detail)
X	Permeable Asphalt Drainage Course, Type P
Y	Rumble Strips

Standardized typical section cells can be found in the roadway design cell library. Ensure the pavement design shown on the typical section and pavement schedules correspond to the approved Pavement Design. Delete or modify descriptions as needed based on the design of the project.

When developing a pavement schedule refer to the following examples of how the information is to be displayed in the pavement schedule.

#### 13.5.2.1 Concrete Pavement and Friction Course

A1 \_\_\_" Portland Cement Concrete Pavement

A2 \_\_\_" Continuously Reinforced Concrete Pavement

B Prop. Open-Graded Asphalt Friction Course, Type FC\_\_\_, at an average rate of \_\_\_ lbs. per sq. yd.

#### 13.5.2.2 Surface Course

C1 Prop. Approx. " Asphalt Concrete Surface Course, Type S \_\_\_, at an average rate of \_\_\_lbs. per sq. yard.

- C2 Prop. Approx. " Asphalt Concrete Surface Course, Type S \_\_\_, at an average rate of \_\_\_ lbs. per sq. yard in each of two layers.
- C3 Prop. Var. Depth Asphalt Concrete Surface Course, Type S \_\_\_, at an average rate of \_\_\_ lbs. per sq. yard per 1" depth to be placed in layers not to exceed \_\_\_" in depth.

### 13.5.2.3 Intermediate Course

- D1 Prop. Approx. " Asphalt Concrete Intermediate Course, Type I19.0\_\_\_, at an average rate of \_\_\_ lbs. per sq. yard.
- D2 Prop. Approx. " Asphalt Concrete Intermediate Course, Type I19.0\_\_\_, at an average rate of \_\_\_ lbs. per sq. yard in each of two layers.
- D3 Prop. Var. Depth Asphalt Concrete Intermediate Course, Type I19.0\_\_\_, at an average rate of 114 lbs. per sq. yard per 1" depth to be placed in layers not less than 2 1/2" or greater than 4" in depth.

### 13.5.2.4 Base Course

- E1 Prop. Approx. \_\_\_" Asphalt Concrete Base Course, Type B\_\_\_, at an average rate of \_\_\_ lbs. per sq. yard.
- E2 Prop. Approx. \_\_\_" Asphalt Concrete Base Course, Type B\_\_\_, at an average rate of \_\_\_ lbs. per sq. yard in each of two layers.
- E3 Prop. Var. Depth Asphalt Concrete Base Course, Type B\_\_\_, at an average rate of 114 lbs. per sq. yd. per 1" depth, to be placed in layers not greater than \_\_\_" in depth or less than \_\_\_" in depth.
- F1 Asphalt Surface Treatment, Mat and Seal.
- F2 Asphalt Surface Treatment, \_\_\_
- G Prop. Approx. \_\_\_" Cement Treated Base Course (Plant Mixed), or  
Prop. \_\_\_" ABC with the top 7" to be Cement Treated (Road Mixed).
- J1 Prop. \_\_\_" Aggregate Base Course
- J2 Prop. \_\_\_" Aggregate Base Course
- J3 Prop. Var. Depth Aggregate Base Course
- K1 Prop. \_\_\_" Chemical Stabilization (Soil-Cement Base/Lime-Treated Soil). Base treated with Cement at a Rate of 55 lbs. per sq. yard or Soil treated with Lime at a rate of 20 lbs. per sq. yard.
- K2 Prop. \_\_\_" Class IV Subgrade Stabilization
- L Base to be stabilized with 200 to 400 lbs. per sq. yard of Stabilizer Aggregate mixed with the top 3" of subgrade soil at locations directed by the Engineer.
- M1 Prop. \_\_\_" Soil Type Base Course, Type A
- M2 Prop. \_\_\_" Soil Type Base Course, Type \_\_\_

### 13.5.2.5 Others

- N1 Geotextile for Subgrade Stabilization
- N2 Geotextile for Soil Stabilization

N3	Non-Woven Geotextile Interlayer
P1	Prime Coat at the rate of .35 gal. per sq. yard.
P2	Prime Coat at the rate of .50 gal. per sq. yard.
R3	8" x 6" Concrete Curb
R4	_ " x _ " Concrete Curb
R5	5" Monolithic Concrete Island (surface mounted)
R6	5" Monolithic Concrete Island (keyed in)
R7	3" Concrete Island Cover
R8	_ " Concrete Island Cover
S	4" Concrete Sidewalk
S1	_ ' Sidepath or _ " Sidepath (See Special Provision) _ ' Shared-use path or _ " Shared-use path (See Special Provision)
T	Earth Material
U	Existing Pavement
V	Milling
W	Variable Depth Asphalt Pavement (See Standard Wedging Detail Sheet No.)
X	Permeable Asphalt Drainage Course – Type P- _
Y	Rumble Strips

Table 13-3 lists the minimum and maximum pavement thickness to ensure proper compaction and maintain pavement integrity.

Refer to the NCDOT Material and Tests Unit's [NCDOT Asphalt Quality Management System Manual](#) for detailed guidance.

**Table 13-3 Minimum and Maximum Pavement Thickness**

Mix Type	English (inches)		
	<i>Minimum Lift</i> <sup>1</sup>	<i>Maximum Lift</i>	<i>Normal Total Layer</i>
SA-1	0.5	1.0	2.0
S4.75A	0.75	1.0	2.0
S9.5B	1.0 <sup>2</sup>	1.5	3.0
S9.5C, D	1.5	2.0	3.0
I19.0C	2.5	4.0	4.0
B25.0C	3.0 <sup>3</sup>	5.5	-

Notes:

1. Approximate minimum lift thickness; lower rates may be used for leveling courses.
2. For S9.5B placed on top of AST MAT coat, minimum lift thickness is 1.5 inches.
3. For B25.0C placed on unstabilized subgrade, minimum lift thickness is 4.0 inches.

Table 13-4 lists the percent asphalt binder, asphalt binder grade, and the rate of application for each asphalt mix type. Use the percentage of asphalt binder and the rate of application in calculating the asphalt binder quantities. Use the asphalt binder grade to determine whether the

asphalt binder for plant mix or polymer modified asphalt binder for plant mix pay items will be specified in the engineers estimate.

Table 13-4 Properties of Asphalt Mix Types

Mix Type	% Asphalt Binder	Asphalt Binder Grade	Rate (lbs./SY/in)
<b>Friction</b>			
OGAFC, Type FC-1 Modified	6.2	PG 76-22	70-90 lbs./SY
<b>Surface</b>			
SA-1	6.8	PG 64-22	100
S4.75A	7.0	PG 64-22	<del>110</del> 109
S9.5B	6.5	PG 64-22	110
S9.5C	5.9	PG 64-22	112
S9.5D	5.8	PG 76-22	112
<b>Intermediate</b>			
I19.0C	4.8	PG 64-22	114
<b>Base</b>			
B25.0C	4.5	PG 64-22	114
PADC, Type P-57	3.0	PG 64-22	90
PADC, Type P-78M	3.0	PG 64-22	90

Note: Group like pavement mixtures together in the pavement schedule.

### 13.5.3 Typical Details and Notes

The roadway designer is responsible for incorporating details into the typical sections to clarify the design for construction. The following details are commonly included with the typical sections:

- Wedging detail(s)
- Asphalt wearing surface on cored slab and box beam bridges
- Concrete barrier detail(s)
- Incidental milling detail
- Shoulder drain detail (obtained from Pavement Design)

The roadway designer may also decide whether to incorporate any note in the typical sections to clarify the design for construction. Make notes clear and concise.

Standard cells have been created for many of these typical details.

## 13.6 Detail Sheets

Provide details in the roadway plans for any construction details not included in the [NCDOT Roadway Standard Drawings](#). The roadway designer is responsible for preparing and/or acquiring all detail sheets to be incorporated into the roadway plans. Include the following typical types of details in the construction plans as needed:

- Roadway detail sheets (2B-Series)
- Special detail sheets (2C-Series)
- Drainage detail sheets (2D-Series)
- Geotechnical details (2G-Series)
- Geoenvironmental details (2H-Series)
- Noise wall envelopes (2N-Series)
- Miscellaneous details

Coordinate with the [State Plans and Standards Engineer](#) before special construction details are drawn for a project. The Plans and Standard Engineer has special drawings which can be adapted to fit most projects.

### 13.6.1 Roadway Detail Sheets (2B-Series)

All 2B-Series detail sheets are the responsibility of the roadway designer. Any roadway details the roadway designer feels would be helpful in clarifying the design and aiding in construction can be added as a 2B-Series detail. Where applicable, the 2B-Series details typically include but are not limited to the following:

- Intersection and monolithic island details
- Interchange details
- Temporary detour (if not a part of the roadway plan sheets)
- Cross section layout
- False cuts

#### 13.6.1.1 Intersection and Monolithic Island Detail

If the plans are cluttered, the designer may choose to include a detail sheet for the intersections. Intersection details typically show such things as the radii, island configurations, layout of intersection, and dimensioning on a larger scale than shown on the plan sheets. It is the intent of the intersection details to provide specific guidance on how to construct the intersection in a level of detail not achievable on the plan view.

#### 13.6.1.2 Interchange Detail

Include interchange detail sheets to help reduce clutter.

#### 13.6.1.3 Temporary Detour

A separate detail sheet may be warranted for temporary detours to reduce plan sheet clutter. The 2B-Series detour detail sheet is intended to supplement the roadway plans.

#### 13.6.1.4 Cross Section Layout

Include cross section layout details, also referred to as shear point diagrams, in all final plans that have interchange designs more complex than a standard diamond. Include this detail in the 2B-Series sheets and show lines indicating where individual cross sections have been cut and where they intersect. Clearly label intersecting shear points in the detail and properly reference the corresponding cross section template.

### 13.6.1.5 False Cuts

False cuts are designed to eliminate or reduce hazards and may sometimes be used for noise abatement. Utilization of a false cut must be based on a project-by-project basis with strong considerations given to economics, aesthetics, safety, and engineering judgement. See Figure 13-2 and Figure 13-3 for examples of false cuts.



Figure 13-2 False Cut in Draw Between Cut Slopes

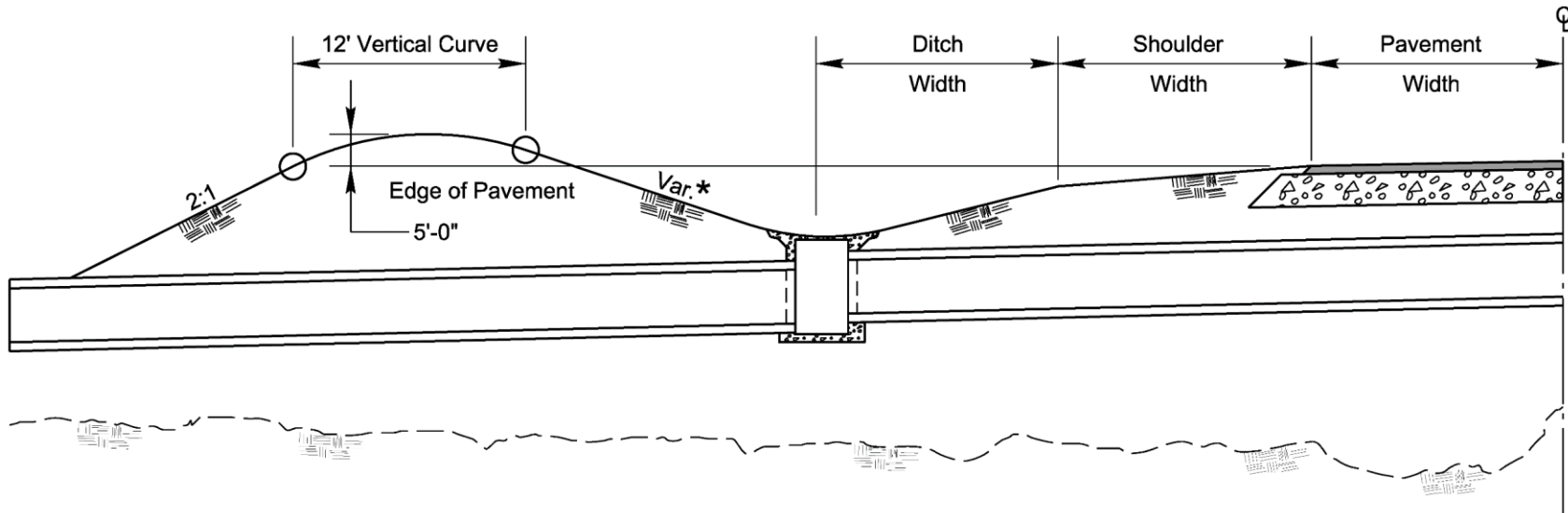

Notes:

1. For use in locations where it can be constructed without its costs exceeding approximately two times the cost of providing guardrail.
2. (\*) Blend slope to match adjacent cut slope. No flatter than 3:1

Figure 13-3 False Cut to be Used on Waste Projects Where Fill Height Exceeds 30"

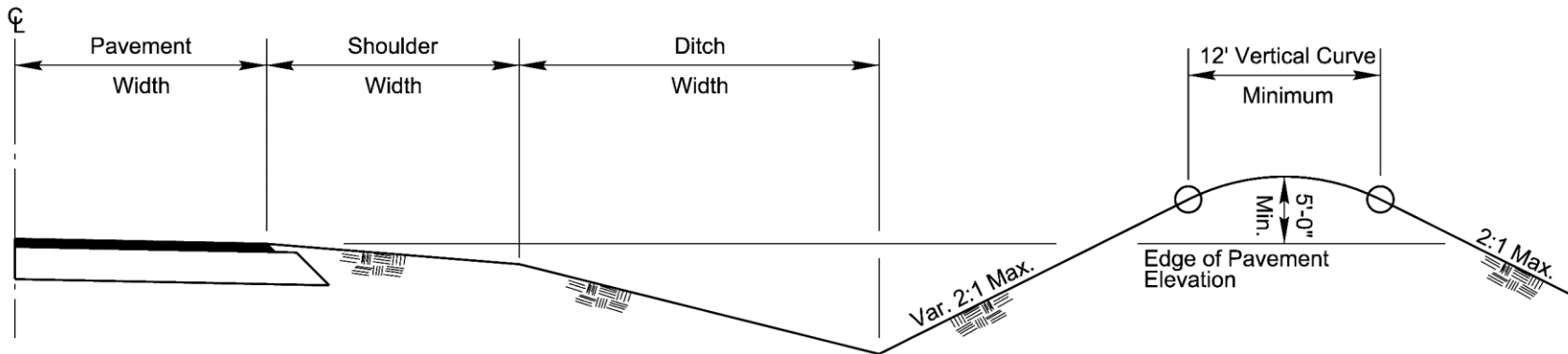

### 13.6.2 Special Detail Sheets not covered by Roadway (2C-Series)

Incorporate special details prepared by the State Plan and Standards Engineer into the plans as 2C-Series plan sheets. Special details are needed when a standard drawing needs to be modified or if a roadway detail needed for construction is not included in the [NCDOT Roadway Standard Drawings](#). The roadway designer is responsible for identifying whether a special detail is needed. Coordinate with the State Plans and Standards Engineer to obtain the necessary construction detail. To request a special detail, submit an email to the [State Plans and Standards Engineer](#) providing the following information:

- TIP number
- County
- WBS number
- Letting date
- Project turn in date to Contract Standards and Development
- Project Manager
- Description of detail(s)
- Attached plans or drawings, if needed, to clarify the needed detail

#### 13.6.2.1 Details in Lieu of Standards

The NCDOT Roadway Standard Drawings are updated approximately every six years. During this timeframe, some standard drawings are revised to reflect changes in design practices. Refer to the details in lieu of standards referenced in the latest [NCDOT Roadway Standard Drawings](#) on the Contract Resources website. Insert any applicable detail in lieu of standards into the Contract Roadway Design Plans.

#### 13.6.2.2 Special Details

Incorporate special details into a project as needed. These include, but are not limited to:

- Alternate curb ramp designs
- 25-foot clear span guardrail detail
- Double faced guardrail detail
- Updated guardrail and guiderail standard drawings
- Bridge approach fill details
- Modified method of clearing (when applicable)

Consult the [State Plans and Standards Engineer](#) or Plan Review Engineer before placing special details in the roadway plans.

### 13.6.3 Drainage Details (2D-Series)

Special drainage and ditch details may be included in the roadway plans as 2D-Series plan sheets rather than including these details on the roadway plan sheets. The drainage detail sheets are intended to consolidate all the drainage details in one location if needed to reduce

plan sheet clutter. The hydraulics engineer is responsible for preparing, sealing, and submitting the drainage detail sheets for inclusion in the roadway plans.

#### 13.6.4 Geotechnical Details (2G-Series)

Special geotechnical detail sheets may be included in the roadway plans as 2G-Series plan sheets. [NCDOT Geotechnical Support Services](#) is responsible for preparing and submitting the geotechnical details. The geotechnical engineer will place the completed details on the preconstruction project team site on Connect NCDOT in the LET Preparation/Final Plans folder. Examples of geotechnical standard details include, but are not limited to:

- Retaining wall details
- Standard horizontal drain
- Standard temporary shoring
- Standard temporary wall
- Standard reinforced soil slope

#### 13.6.5 Geoenvironmental Details (2H-Series)

Special geoenvironmental detail sheets may be included in the roadway plans as 2H-Series plan sheets when applicable. The geotechnical engineer will place the completed details on the preconstruction project team site on Connect NCDOT in the LET Preparation/Final Plans folder. The [GeoEnvironmental Engineering Supervisor](#) is responsible for preparing, sealing, and submitting the geoenvironmental details. The geoenvironmental details typically involve the handling of contaminated materials from sites of concern which include, but are not limited to, active and abandoned underground storage tank sites, hazardous waste sites, dry cleaners, maintenance facilities, regulated landfills, and unregulated dumpsites.

#### 13.6.6 Noise Wall Envelopes (2N-Series)

The Traffic Noise and Air Quality specialist or consultant is responsible for developing the Design Noise Report. The Design Noise Report evaluates the selected alternative, considers mitigation for all impacted receptors, and creates the noise wall envelopes for any noise wall that is found to be feasible and reasonable. The Traffic Noise and Air Quality group is responsible for providing the noise wall envelopes to the roadway designer and coordinating with the Structures Management Unit to develop the noise wall plans. When barriers for noise abatement (also known as noise walls) are included in a project, place a noise wall envelope in the roadway plans as 2N-Series plan sheets. Coordinate with the [NCDOT Traffic Noise and Air Quality Group Leader](#) if there are questions pertaining to noise walls on the project.

Refer to RDM Part I Chapter 5 Section 5.4 for additional guidance.

### 13.7 Summary Sheets

The summary of quantity sheets document specific pay item quantities by location. Ensure the pay items shown in the summaries agree with the description, quantity, and unit listed on the [NCDOT Master Pay Item List](#).

Place the summary of quantity sheets in the roadway plans as 3-Series sheets. The most common summaries generated by the designer include, but are not limited to, earthwork summaries, guardrail/guiderail summaries, pavement removal/break-up summaries, shoulder

drain summaries, fence summaries, drainage summaries, geotechnical summaries, and parcel index sheets.

### 13.7.1 Miscellaneous Roadway Summaries (3B-Series)

Show a separate summary for the items listed below when the associated pay items are applicable to the project:

- Earthwork Summary
- Guardrail and Temporary Guardrail Summaries
- Guiderail Summary
- Fence Summary (Typically for Urban Projects)
- Pavement Removal Summary
- Breaking of Existing Pavement Summary
- Shoulder Drains Summary

#### 13.7.1.1 Earthwork Summary

The purpose of the earthwork summary is to provide the contractor with an overview of the location, type, and quantity of the proposed roadway excavation on the project and is derived from the information shown on the earthwork balance sheet. Providing the contractor with accurate earthwork information is extremely important, since earthwork pay items are a significant portion of the overall project cost.

Refer to RDM Part II Chapter 15 Section 15.4.1.1 for additional guidance on preparing the NCDOT Earthwork Balance Sheet.

Show the earthwork summary in the roadway plans as a 3B-Series plan sheet. Only the station to station, total unclassified, undercut excavation, embankment (+%), borrow, and total waste columns should be shown on the earthwork summary. Do not show the shrinkage factor in the embankment +% column on the earthwork summary.

Include the following note on all earthwork summary sheets:

“Note: Earthwork quantities are calculated by the roadway designer. These earthwork quantities are based in part on subsurface data provided by the Geotechnical Engineering Unit.”

When the lump sum grading pay item is included in the final construction estimate, include the following note on the earthwork summary sheet (3B-Series plan sheet). Remove any pay items that are not applicable to the project.

“Note: Approximate quantities only. Unclassified excavation, borrow excavation, shoulder borrow, fine grading, clearing and grubbing, breaking of existing pavement, and removal of existing pavement will be paid for at the contract lump sum price for grading.”

Earthwork summaries can be very complex. Factors such as select borrow, hard rock, degradable rock, rock swell, earth shrinkage, suitable unclassified excavation, and unsuitable unclassified excavation have an impact on earthwork quantities.

Refer to RDM Part II Chapter 15 Section 15.4 for detailed guidance on the development of the earthwork summary and associated pay items.

Refer to the [Example Earthwork Summary](#) provided by NCDOT.

### 13.7.1.2 Pavement Alternate Base Course Materials

Major new location and existing two-lane facilities widened to four lanes may require alternate base course materials. The alternate base course recommendation will allow the contractor the choice to construct either a pavement with aggregate base course or asphalt concrete base course. Pavement Management will select which projects require alternate base course materials and provide direction in the final pavement design memo.

Show the aggregate base course design on the roadway typical sections. Use details or insets to supplement the typical sections that show the asphalt concrete base course alternative (Figure 13-4 ). Pavement Design will furnish the applicable shoulder drain designs for each alternate design. When coordinating with other units, specify that all work related to the geotechnical engineering, hydraulics, and utilities be performed using the aggregate base course alternate.

Earthwork quantities are required for both the aggregate base course and asphalt concrete base course alternates. However, plans will include a single earthwork summary based on the aggregate base course alternate with a line item added to the bottom of the earthwork summary showing the differential volumes of the alternate design. Submit a combined earthwork balance sheet of both alternates to the Geotechnical Engineering Unit for use in preparing the subsurface plans (Figure 13-5).

Use the aggregate base course alternate to prepare cross sections with a note on all cross section summary sheets and the first cross section sheet (in addition to other standard notes) as follows:

“The cross sections reflect the aggregate base course alternate.”

Compute and show any pay item quantities affected by the alternate base course materials on the estimate within the alternate in which they apply. Possible pay items that are required to be shown within each alternate include unclassified excavation, borrow excavation (borrow projects), aggregate base course, asphalt concrete base course, asphalt binder, prime coat and shoulder borrow (waste projects).

Figure 13-4 Alternate Base Course Material Earthwork sample

COMPUTED BY: B. YORK      DATE: SEPT. 2005 CHECKED BY: T. BURNS      DATE: SEPT. 2005	STATE OF NORTH CAROLINA DIVISION OF HIGHWAYS <b>SUMMARY OF EARTHWORK</b> <i>IN CUBIC YARDS</i>	PROJECT REFERENCE NO. R-06281A SHEET NO. 3-R																																																																																																																																																																																																																																																																																																																																																																																																																																																																																															
NOTE: Earthwork quantities are calculated by the Roadway Design Unit. These earthwork quantities are based in part on subsurface data provided by the Geotechnical Engineering Unit.																																																																																																																																																																																																																																																																																																																																																																																																																																																																																																	
<table border="1" style="width:100%; border-collapse: collapse; font-size: x-small;"> <thead> <tr> <th>LOCATION</th> <th>UNCL. EXCAVATION</th> <th>UNDERCUT</th> <th>EMBT+%</th> <th>BORROW</th> <th>WASTE</th> </tr> </thead> <tbody> <tr><td colspan="6"><b>SUMMARY NO. 1</b></td></tr> <tr><td>-L- 11+98.805 TO 19+00.000</td><td>163,668</td><td></td><td>2,638</td><td></td><td>161,030</td></tr> <tr><td>-Y- 10+00.000 TO 13+40.000</td><td>3,850</td><td></td><td>554</td><td></td><td>3,296</td></tr> <tr><td>-Y1- 10+00.000 TO 12+26.533</td><td>1,395</td><td></td><td>581</td><td></td><td>814</td></tr> <tr><td>-Y1- 13+03.733 TO 14+20.000</td><td>507</td><td></td><td>107</td><td></td><td>400</td></tr> <tr><td>-Y1 DET- 10+29.365 TO 14+16.948</td><td>2,827</td><td></td><td>4,504</td><td>1,677</td><td></td></tr> <tr><td>DETOUR REMOVAL</td><td></td><td></td><td>3,062</td><td>3,062</td><td></td></tr> <tr><td><b>SUMMARY NO. 1 TOTAL</b></td><td><b>172,247</b></td><td></td><td><b>11,446</b></td><td><b>4,739</b></td><td><b>165,540</b></td></tr> <tr><td colspan="6"><b>SUMMARY NO. 2</b></td></tr> <tr><td>-L- 19+00.000 TO 26+17.519 L.B.</td><td>24,365</td><td></td><td>145,723</td><td>121,358</td><td></td></tr> <tr><td><b>SUMMARY NO. 2 TOTAL</b></td><td><b>24,365</b></td><td></td><td><b>145,723</b></td><td><b>121,358</b></td><td></td></tr> <tr><td colspan="6"><b>SUMMARY NO. 3</b></td></tr> <tr><td>-L- 25+77.880 L.A. TO 35+00.000</td><td>168,012</td><td>1,300</td><td>108,846</td><td></td><td>60,466</td></tr> <tr><td>-Y2- 10+00.000 TO 13+07.000</td><td>5,013</td><td></td><td>6,870</td><td>1,857</td><td></td></tr> <tr><td>-Y2- 14+20.000 TO 17+39.078</td><td>768</td><td>600</td><td>24,275</td><td>23,507</td><td>600</td></tr> <tr><td><b>SUMMARY NO. 3 TOTAL</b></td><td><b>173,793</b></td><td><b>1,900</b></td><td><b>139,991</b></td><td><b>25,364</b></td><td><b>61,066</b></td></tr> <tr><td colspan="6"><b>SUMMARY NO. 4</b></td></tr> <tr><td>-L- 35+00.000 TO 44+00.000</td><td>343,420</td><td></td><td>35,086</td><td></td><td>308,334</td></tr> <tr><td>-Y3- 10+00.000 TO 12+26.944</td><td>1,633</td><td></td><td>971</td><td></td><td>662</td></tr> <tr><td>-Y3- 13+02.264 TO 14+54.746</td><td>1,097</td><td></td><td>690</td><td></td><td>407</td></tr> <tr><td>-Y4- 10+00.000 TO 16+55.785</td><td>4,324</td><td></td><td>26,150</td><td>21,826</td><td></td></tr> <tr><td>-DET2- 12+37.210 TO 15+52.083</td><td>5,014</td><td></td><td>451</td><td></td><td>4,563</td></tr> <tr><td>-DET3- 12+51.082 TO 12+95.313</td><td>84</td><td></td><td>0</td><td></td><td>84</td></tr> <tr><td><b>SUMMARY NO. 4 TOTAL</b></td><td><b>355,572</b></td><td></td><td><b>63,348</b></td><td><b>21,826</b></td><td><b>314,050</b></td></tr> <tr><td colspan="6"><b>SUMMARY NO. 5</b></td></tr> <tr><td>-L- 44+00.000 TO 53+00.000</td><td>396,205</td><td>9,200</td><td>54,924</td><td></td><td>350,476</td></tr> <tr><td>-Y5- 10+00.000 TO 19+45.115</td><td>5,219</td><td>800</td><td>1,930</td><td></td><td>4,089</td></tr> <tr><td>-RPB- 11+53.455 TO 15+26.124</td><td>21,810</td><td></td><td>27,978</td><td>6,168</td><td></td></tr> <tr><td>-RPC- 11+94.366 TO 14+94.366</td><td>543</td><td></td><td>32,014</td><td>31,471</td><td></td></tr> <tr><td>-LPB- 10+67.281 TO 12+51.310</td><td>0</td><td></td><td>62,292</td><td>62,292</td><td></td></tr> <tr><td>-LPC- 10+43.870 TO 12+30.352</td><td>5,399</td><td></td><td>30,923</td><td>25,524</td><td></td></tr> <tr><td>-FLY- 12+76.258 TO 18+50.963</td><td>45,289</td><td></td><td>151,585</td><td>106,296</td><td></td></tr> <tr><td>-Y6- 13+38.426 TO 20+85.589</td><td>12,910</td><td></td><td>17,308</td><td>4,398</td><td></td></tr> <tr><td>-Y6- 21+69.189 TO 28+00.000</td><td>25,899</td><td></td><td>47,316</td><td>21,417</td><td></td></tr> <tr><td>-Y6- 28+00.000 TO 36+00.000</td><td>25,504</td><td></td><td>47,426</td><td>21,922</td><td></td></tr> <tr><td>-Y6- 36+00.000 TO 45+00.000</td><td>9,727</td><td></td><td>106</td><td></td><td>9,621</td></tr> <tr><td>-Y6- 45+00.000 TO 49+70.000</td><td>1,887</td><td></td><td>419</td><td></td><td>1,468</td></tr> <tr><td><b>SUMMARY NO. 5 TOTAL</b></td><td><b>550,392</b></td><td><b>10,000</b></td><td><b>474,226</b></td><td><b>279,488</b></td><td><b>365,654</b></td></tr> </tbody> </table>	LOCATION	UNCL. EXCAVATION	UNDERCUT	EMBT+%	BORROW	WASTE	<b>SUMMARY NO. 1</b>						-L- 11+98.805 TO 19+00.000	163,668		2,638		161,030	-Y- 10+00.000 TO 13+40.000	3,850		554		3,296	-Y1- 10+00.000 TO 12+26.533	1,395		581		814	-Y1- 13+03.733 TO 14+20.000	507		107		400	-Y1 DET- 10+29.365 TO 14+16.948	2,827		4,504	1,677		DETOUR REMOVAL			3,062	3,062		<b>SUMMARY NO. 1 TOTAL</b>	<b>172,247</b>		<b>11,446</b>	<b>4,739</b>	<b>165,540</b>	<b>SUMMARY NO. 2</b>						-L- 19+00.000 TO 26+17.519 L.B.	24,365		145,723	121,358		<b>SUMMARY NO. 2 TOTAL</b>	<b>24,365</b>		<b>145,723</b>	<b>121,358</b>		<b>SUMMARY NO. 3</b>						-L- 25+77.880 L.A. TO 35+00.000	168,012	1,300	108,846		60,466	-Y2- 10+00.000 TO 13+07.000	5,013		6,870	1,857		-Y2- 14+20.000 TO 17+39.078	768	600	24,275	23,507	600	<b>SUMMARY NO. 3 TOTAL</b>	<b>173,793</b>	<b>1,900</b>	<b>139,991</b>	<b>25,364</b>	<b>61,066</b>	<b>SUMMARY NO. 4</b>						-L- 35+00.000 TO 44+00.000	343,420		35,086		308,334	-Y3- 10+00.000 TO 12+26.944	1,633		971		662	-Y3- 13+02.264 TO 14+54.746	1,097		690		407	-Y4- 10+00.000 TO 16+55.785	4,324		26,150	21,826		-DET2- 12+37.210 TO 15+52.083	5,014		451		4,563	-DET3- 12+51.082 TO 12+95.313	84		0		84	<b>SUMMARY NO. 4 TOTAL</b>	<b>355,572</b>		<b>63,348</b>	<b>21,826</b>	<b>314,050</b>	<b>SUMMARY NO. 5</b>						-L- 44+00.000 TO 53+00.000	396,205	9,200	54,924		350,476	-Y5- 10+00.000 TO 19+45.115	5,219	800	1,930		4,089	-RPB- 11+53.455 TO 15+26.124	21,810		27,978	6,168		-RPC- 11+94.366 TO 14+94.366	543		32,014	31,471		-LPB- 10+67.281 TO 12+51.310	0		62,292	62,292		-LPC- 10+43.870 TO 12+30.352	5,399		30,923	25,524		-FLY- 12+76.258 TO 18+50.963	45,289		151,585	106,296		-Y6- 13+38.426 TO 20+85.589	12,910		17,308	4,398		-Y6- 21+69.189 TO 28+00.000	25,899		47,316	21,417		-Y6- 28+00.000 TO 36+00.000	25,504		47,426	21,922		-Y6- 36+00.000 TO 45+00.000	9,727		106		9,621	-Y6- 45+00.000 TO 49+70.000	1,887		419		1,468	<b>SUMMARY NO. 5 TOTAL</b>	<b>550,392</b>	<b>10,000</b>	<b>474,226</b>	<b>279,488</b>	<b>365,654</b>	<table border="1" style="width:100%; border-collapse: collapse; font-size: x-small;"> <thead> <tr> <th>LOCATION</th> <th>UNCL. EXCAVATION</th> <th>UNDERCUT</th> <th>EMBT+%</th> <th>BORROW</th> <th>WASTE</th> </tr> </thead> <tbody> <tr><td colspan="6"><b>SUMMARY NO. 6</b></td></tr> <tr><td>-L- 53+00.000 TO 61+00.000</td><td>25,225</td><td></td><td>196,495</td><td>171,270</td><td></td></tr> <tr><td>-RPA- 11+14.406 TO 14+23.096</td><td>0</td><td></td><td>96,372</td><td>96,372</td><td></td></tr> <tr><td>-RPD- 11+30.762 TO 14+87.240</td><td>35,027</td><td></td><td>10,250</td><td></td><td>24,777</td></tr> <tr><td>-LPA- 10+34.440 TO 12+28.790</td><td>0</td><td></td><td>56,563</td><td>56,563</td><td></td></tr> <tr><td>-FLY- 20+12.663 TO 21+45.365</td><td>48</td><td></td><td>57,430</td><td>57,382</td><td></td></tr> <tr><td>-FLY- 22+45.365 TO 27+05.599</td><td>28,653</td><td></td><td>124,396</td><td>95,743</td><td></td></tr> <tr><td>-Y6- 13+27.416 TO 20+92.218</td><td>26,713</td><td></td><td>11,202</td><td></td><td>15,511</td></tr> <tr><td>-Y6- 21+75.818 TO 28+00.000</td><td>30,058</td><td></td><td>40,392</td><td>10,334</td><td></td></tr> <tr><td>-Y6- 28+00.000 TO 37+00.000</td><td>54,683</td><td></td><td>35,752</td><td></td><td>18,931</td></tr> <tr><td>-Y6- 37+00.000 TO 45+80.000</td><td>10,026</td><td></td><td>632</td><td></td><td>9,394</td></tr> <tr><td><b>SUMMARY NO. 6 TOTAL</b></td><td><b>210,433</b></td><td></td><td><b>629,484</b></td><td><b>487,664</b></td><td></td></tr> <tr><td colspan="6"><b>SUMMARY TOTALS</b></td></tr> <tr><td>ADDITIONAL UNDERCUT</td><td>1,486,802</td><td>11,900</td><td>1,464,218</td><td>940,439</td><td>974,923</td></tr> <tr><td>LOST DUE TO CLEAR. &amp; GRUB.</td><td>-15,000</td><td>7,000</td><td>8,400</td><td>8,400</td><td>7,000</td></tr> <tr><td>ROCK WASTE IN LIEU OF BORROW</td><td></td><td></td><td></td><td>-13,524</td><td>-13,524</td></tr> <tr><td>EARTH WASTE IN LIEU OF BORROW</td><td></td><td></td><td></td><td>-948,644</td><td>-948,644</td></tr> <tr><td>ADJ. FOR ROCK WASTE</td><td></td><td></td><td>-2,705</td><td>-2,705</td><td></td></tr> <tr><td>SHOULDER MATERIAL</td><td></td><td></td><td>72,600</td><td>72,600</td><td></td></tr> <tr><td><b>PROJECT TOTALS</b></td><td><b>1,471,802</b></td><td><b>18,900</b></td><td><b>1,542,513</b></td><td><b>71,566</b></td><td><b>19,755</b></td></tr> <tr><td colspan="6">EST. TO REPLACE TOP</td></tr> <tr><td>SOIL ON BORROW PITS</td><td></td><td></td><td></td><td>3,578</td><td></td></tr> <tr><td><b>GRAND TOTALS</b></td><td><b>1,471,802</b></td><td><b>18,900</b></td><td></td><td><b>75,144</b></td><td><b>19,755</b></td></tr> <tr><td>SAY</td><td>1,472,000</td><td></td><td></td><td>75,200</td><td></td></tr> <tr><td>PAV'T STRUCTURE VOLUME -L-</td><td>*40,441 Cu. Yds.</td><td></td><td></td><td></td><td></td></tr> <tr><td colspan="6"><b>EARTHWORK TOTALS FOR ALTERNATE PAV'T DESIGN</b></td></tr> <tr><td><b>SUMMARY TOTALS</b></td><td><b>1,486,802</b></td><td><b>11,900</b></td><td><b>1,464,218</b></td><td><b>940,439</b></td><td><b>974,923</b></td></tr> <tr><td>ADJ. FOR ALT. PAV'T DESIGN</td><td>-16,000</td><td></td><td>10,122</td><td>10,122</td><td>-16,000</td></tr> <tr><td>ADDITIONAL UNDERCUT</td><td></td><td>7,000</td><td>8,400</td><td>8,400</td><td>7,000</td></tr> <tr><td>LOSS DUE TO CLEAR. &amp; GRUB.</td><td>-15,000</td><td></td><td></td><td></td><td>15,000</td></tr> <tr><td>ROCK WASTE IN LIEU OF BORROW</td><td></td><td></td><td></td><td>-13,524</td><td>-13,524</td></tr> <tr><td>EARTH WASTE IN LIEU OF BORROW</td><td></td><td></td><td></td><td>-932,644</td><td>-932,644</td></tr> <tr><td>ADJUSTMENT FOR ROCK WASTE</td><td></td><td></td><td>-2,705</td><td>-2,705</td><td></td></tr> <tr><td>SHOULDER MATERIAL</td><td></td><td></td><td>54,450</td><td>54,450</td><td></td></tr> <tr><td><b>PROJECT TOTALS</b></td><td><b>1,455,802</b></td><td><b>18,900</b></td><td><b>1,534,485</b></td><td><b>79,538</b></td><td><b>19,755</b></td></tr> <tr><td colspan="6">EST. TO REPLACE TOP</td></tr> <tr><td>SOIL ON BORROW PITS</td><td></td><td></td><td></td><td>3,977</td><td></td></tr> <tr><td><b>TOTAL</b></td><td><b>1,455,802</b></td><td><b>18,900</b></td><td></td><td><b>83,515</b></td><td></td></tr> <tr><td>SAY</td><td>1,455,900</td><td>18,900</td><td></td><td>83,600</td><td></td></tr> <tr><td>PAV'T STRUCTURE VOLUME -L-</td><td>** 29,956 Cu. Yds.</td><td></td><td></td><td></td><td></td></tr> </tbody> </table>	LOCATION	UNCL. EXCAVATION	UNDERCUT	EMBT+%	BORROW	WASTE	<b>SUMMARY NO. 6</b>						-L- 53+00.000 TO 61+00.000	25,225		196,495	171,270		-RPA- 11+14.406 TO 14+23.096	0		96,372	96,372		-RPD- 11+30.762 TO 14+87.240	35,027		10,250		24,777	-LPA- 10+34.440 TO 12+28.790	0		56,563	56,563		-FLY- 20+12.663 TO 21+45.365	48		57,430	57,382		-FLY- 22+45.365 TO 27+05.599	28,653		124,396	95,743		-Y6- 13+27.416 TO 20+92.218	26,713		11,202		15,511	-Y6- 21+75.818 TO 28+00.000	30,058		40,392	10,334		-Y6- 28+00.000 TO 37+00.000	54,683		35,752		18,931	-Y6- 37+00.000 TO 45+80.000	10,026		632		9,394	<b>SUMMARY NO. 6 TOTAL</b>	<b>210,433</b>		<b>629,484</b>	<b>487,664</b>		<b>SUMMARY TOTALS</b>						ADDITIONAL UNDERCUT	1,486,802	11,900	1,464,218	940,439	974,923	LOST DUE TO CLEAR. & GRUB.	-15,000	7,000	8,400	8,400	7,000	ROCK WASTE IN LIEU OF BORROW				-13,524	-13,524	EARTH WASTE IN LIEU OF BORROW				-948,644	-948,644	ADJ. FOR ROCK WASTE			-2,705	-2,705		SHOULDER MATERIAL			72,600	72,600		<b>PROJECT TOTALS</b>	<b>1,471,802</b>	<b>18,900</b>	<b>1,542,513</b>	<b>71,566</b>	<b>19,755</b>	EST. TO REPLACE TOP						SOIL ON BORROW PITS				3,578		<b>GRAND TOTALS</b>	<b>1,471,802</b>	<b>18,900</b>		<b>75,144</b>	<b>19,755</b>	SAY	1,472,000			75,200		PAV'T STRUCTURE VOLUME -L-	*40,441 Cu. Yds.					<b>EARTHWORK TOTALS FOR ALTERNATE PAV'T DESIGN</b>						<b>SUMMARY TOTALS</b>	<b>1,486,802</b>	<b>11,900</b>	<b>1,464,218</b>	<b>940,439</b>	<b>974,923</b>	ADJ. FOR ALT. PAV'T DESIGN	-16,000		10,122	10,122	-16,000	ADDITIONAL UNDERCUT		7,000	8,400	8,400	7,000	LOSS DUE TO CLEAR. & GRUB.	-15,000				15,000	ROCK WASTE IN LIEU OF BORROW				-13,524	-13,524	EARTH WASTE IN LIEU OF BORROW				-932,644	-932,644	ADJUSTMENT FOR ROCK WASTE			-2,705	-2,705		SHOULDER MATERIAL			54,450	54,450		<b>PROJECT TOTALS</b>	<b>1,455,802</b>	<b>18,900</b>	<b>1,534,485</b>	<b>79,538</b>	<b>19,755</b>	EST. TO REPLACE TOP						SOIL ON BORROW PITS				3,977		<b>TOTAL</b>	<b>1,455,802</b>	<b>18,900</b>		<b>83,515</b>		SAY	1,455,900	18,900		83,600		PAV'T STRUCTURE VOLUME -L-	** 29,956 Cu. Yds.				
LOCATION	UNCL. EXCAVATION	UNDERCUT	EMBT+%	BORROW	WASTE																																																																																																																																																																																																																																																																																																																																																																																																																																																																																												
<b>SUMMARY NO. 1</b>																																																																																																																																																																																																																																																																																																																																																																																																																																																																																																	
-L- 11+98.805 TO 19+00.000	163,668		2,638		161,030																																																																																																																																																																																																																																																																																																																																																																																																																																																																																												
-Y- 10+00.000 TO 13+40.000	3,850		554		3,296																																																																																																																																																																																																																																																																																																																																																																																																																																																																																												
-Y1- 10+00.000 TO 12+26.533	1,395		581		814																																																																																																																																																																																																																																																																																																																																																																																																																																																																																												
-Y1- 13+03.733 TO 14+20.000	507		107		400																																																																																																																																																																																																																																																																																																																																																																																																																																																																																												
-Y1 DET- 10+29.365 TO 14+16.948	2,827		4,504	1,677																																																																																																																																																																																																																																																																																																																																																																																																																																																																																													
DETOUR REMOVAL			3,062	3,062																																																																																																																																																																																																																																																																																																																																																																																																																																																																																													
<b>SUMMARY NO. 1 TOTAL</b>	<b>172,247</b>		<b>11,446</b>	<b>4,739</b>	<b>165,540</b>																																																																																																																																																																																																																																																																																																																																																																																																																																																																																												
<b>SUMMARY NO. 2</b>																																																																																																																																																																																																																																																																																																																																																																																																																																																																																																	
-L- 19+00.000 TO 26+17.519 L.B.	24,365		145,723	121,358																																																																																																																																																																																																																																																																																																																																																																																																																																																																																													
<b>SUMMARY NO. 2 TOTAL</b>	<b>24,365</b>		<b>145,723</b>	<b>121,358</b>																																																																																																																																																																																																																																																																																																																																																																																																																																																																																													
<b>SUMMARY NO. 3</b>																																																																																																																																																																																																																																																																																																																																																																																																																																																																																																	
-L- 25+77.880 L.A. TO 35+00.000	168,012	1,300	108,846		60,466																																																																																																																																																																																																																																																																																																																																																																																																																																																																																												
-Y2- 10+00.000 TO 13+07.000	5,013		6,870	1,857																																																																																																																																																																																																																																																																																																																																																																																																																																																																																													
-Y2- 14+20.000 TO 17+39.078	768	600	24,275	23,507	600																																																																																																																																																																																																																																																																																																																																																																																																																																																																																												
<b>SUMMARY NO. 3 TOTAL</b>	<b>173,793</b>	<b>1,900</b>	<b>139,991</b>	<b>25,364</b>	<b>61,066</b>																																																																																																																																																																																																																																																																																																																																																																																																																																																																																												
<b>SUMMARY NO. 4</b>																																																																																																																																																																																																																																																																																																																																																																																																																																																																																																	
-L- 35+00.000 TO 44+00.000	343,420		35,086		308,334																																																																																																																																																																																																																																																																																																																																																																																																																																																																																												
-Y3- 10+00.000 TO 12+26.944	1,633		971		662																																																																																																																																																																																																																																																																																																																																																																																																																																																																																												
-Y3- 13+02.264 TO 14+54.746	1,097		690		407																																																																																																																																																																																																																																																																																																																																																																																																																																																																																												
-Y4- 10+00.000 TO 16+55.785	4,324		26,150	21,826																																																																																																																																																																																																																																																																																																																																																																																																																																																																																													
-DET2- 12+37.210 TO 15+52.083	5,014		451		4,563																																																																																																																																																																																																																																																																																																																																																																																																																																																																																												
-DET3- 12+51.082 TO 12+95.313	84		0		84																																																																																																																																																																																																																																																																																																																																																																																																																																																																																												
<b>SUMMARY NO. 4 TOTAL</b>	<b>355,572</b>		<b>63,348</b>	<b>21,826</b>	<b>314,050</b>																																																																																																																																																																																																																																																																																																																																																																																																																																																																																												
<b>SUMMARY NO. 5</b>																																																																																																																																																																																																																																																																																																																																																																																																																																																																																																	
-L- 44+00.000 TO 53+00.000	396,205	9,200	54,924		350,476																																																																																																																																																																																																																																																																																																																																																																																																																																																																																												
-Y5- 10+00.000 TO 19+45.115	5,219	800	1,930		4,089																																																																																																																																																																																																																																																																																																																																																																																																																																																																																												
-RPB- 11+53.455 TO 15+26.124	21,810		27,978	6,168																																																																																																																																																																																																																																																																																																																																																																																																																																																																																													
-RPC- 11+94.366 TO 14+94.366	543		32,014	31,471																																																																																																																																																																																																																																																																																																																																																																																																																																																																																													
-LPB- 10+67.281 TO 12+51.310	0		62,292	62,292																																																																																																																																																																																																																																																																																																																																																																																																																																																																																													
-LPC- 10+43.870 TO 12+30.352	5,399		30,923	25,524																																																																																																																																																																																																																																																																																																																																																																																																																																																																																													
-FLY- 12+76.258 TO 18+50.963	45,289		151,585	106,296																																																																																																																																																																																																																																																																																																																																																																																																																																																																																													
-Y6- 13+38.426 TO 20+85.589	12,910		17,308	4,398																																																																																																																																																																																																																																																																																																																																																																																																																																																																																													
-Y6- 21+69.189 TO 28+00.000	25,899		47,316	21,417																																																																																																																																																																																																																																																																																																																																																																																																																																																																																													
-Y6- 28+00.000 TO 36+00.000	25,504		47,426	21,922																																																																																																																																																																																																																																																																																																																																																																																																																																																																																													
-Y6- 36+00.000 TO 45+00.000	9,727		106		9,621																																																																																																																																																																																																																																																																																																																																																																																																																																																																																												
-Y6- 45+00.000 TO 49+70.000	1,887		419		1,468																																																																																																																																																																																																																																																																																																																																																																																																																																																																																												
<b>SUMMARY NO. 5 TOTAL</b>	<b>550,392</b>	<b>10,000</b>	<b>474,226</b>	<b>279,488</b>	<b>365,654</b>																																																																																																																																																																																																																																																																																																																																																																																																																																																																																												
LOCATION	UNCL. EXCAVATION	UNDERCUT	EMBT+%	BORROW	WASTE																																																																																																																																																																																																																																																																																																																																																																																																																																																																																												
<b>SUMMARY NO. 6</b>																																																																																																																																																																																																																																																																																																																																																																																																																																																																																																	
-L- 53+00.000 TO 61+00.000	25,225		196,495	171,270																																																																																																																																																																																																																																																																																																																																																																																																																																																																																													
-RPA- 11+14.406 TO 14+23.096	0		96,372	96,372																																																																																																																																																																																																																																																																																																																																																																																																																																																																																													
-RPD- 11+30.762 TO 14+87.240	35,027		10,250		24,777																																																																																																																																																																																																																																																																																																																																																																																																																																																																																												
-LPA- 10+34.440 TO 12+28.790	0		56,563	56,563																																																																																																																																																																																																																																																																																																																																																																																																																																																																																													
-FLY- 20+12.663 TO 21+45.365	48		57,430	57,382																																																																																																																																																																																																																																																																																																																																																																																																																																																																																													
-FLY- 22+45.365 TO 27+05.599	28,653		124,396	95,743																																																																																																																																																																																																																																																																																																																																																																																																																																																																																													
-Y6- 13+27.416 TO 20+92.218	26,713		11,202		15,511																																																																																																																																																																																																																																																																																																																																																																																																																																																																																												
-Y6- 21+75.818 TO 28+00.000	30,058		40,392	10,334																																																																																																																																																																																																																																																																																																																																																																																																																																																																																													
-Y6- 28+00.000 TO 37+00.000	54,683		35,752		18,931																																																																																																																																																																																																																																																																																																																																																																																																																																																																																												
-Y6- 37+00.000 TO 45+80.000	10,026		632		9,394																																																																																																																																																																																																																																																																																																																																																																																																																																																																																												
<b>SUMMARY NO. 6 TOTAL</b>	<b>210,433</b>		<b>629,484</b>	<b>487,664</b>																																																																																																																																																																																																																																																																																																																																																																																																																																																																																													
<b>SUMMARY TOTALS</b>																																																																																																																																																																																																																																																																																																																																																																																																																																																																																																	
ADDITIONAL UNDERCUT	1,486,802	11,900	1,464,218	940,439	974,923																																																																																																																																																																																																																																																																																																																																																																																																																																																																																												
LOST DUE TO CLEAR. & GRUB.	-15,000	7,000	8,400	8,400	7,000																																																																																																																																																																																																																																																																																																																																																																																																																																																																																												
ROCK WASTE IN LIEU OF BORROW				-13,524	-13,524																																																																																																																																																																																																																																																																																																																																																																																																																																																																																												
EARTH WASTE IN LIEU OF BORROW				-948,644	-948,644																																																																																																																																																																																																																																																																																																																																																																																																																																																																																												
ADJ. FOR ROCK WASTE			-2,705	-2,705																																																																																																																																																																																																																																																																																																																																																																																																																																																																																													
SHOULDER MATERIAL			72,600	72,600																																																																																																																																																																																																																																																																																																																																																																																																																																																																																													
<b>PROJECT TOTALS</b>	<b>1,471,802</b>	<b>18,900</b>	<b>1,542,513</b>	<b>71,566</b>	<b>19,755</b>																																																																																																																																																																																																																																																																																																																																																																																																																																																																																												
EST. TO REPLACE TOP																																																																																																																																																																																																																																																																																																																																																																																																																																																																																																	
SOIL ON BORROW PITS				3,578																																																																																																																																																																																																																																																																																																																																																																																																																																																																																													
<b>GRAND TOTALS</b>	<b>1,471,802</b>	<b>18,900</b>		<b>75,144</b>	<b>19,755</b>																																																																																																																																																																																																																																																																																																																																																																																																																																																																																												
SAY	1,472,000			75,200																																																																																																																																																																																																																																																																																																																																																																																																																																																																																													
PAV'T STRUCTURE VOLUME -L-	*40,441 Cu. Yds.																																																																																																																																																																																																																																																																																																																																																																																																																																																																																																
<b>EARTHWORK TOTALS FOR ALTERNATE PAV'T DESIGN</b>																																																																																																																																																																																																																																																																																																																																																																																																																																																																																																	
<b>SUMMARY TOTALS</b>	<b>1,486,802</b>	<b>11,900</b>	<b>1,464,218</b>	<b>940,439</b>	<b>974,923</b>																																																																																																																																																																																																																																																																																																																																																																																																																																																																																												
ADJ. FOR ALT. PAV'T DESIGN	-16,000		10,122	10,122	-16,000																																																																																																																																																																																																																																																																																																																																																																																																																																																																																												
ADDITIONAL UNDERCUT		7,000	8,400	8,400	7,000																																																																																																																																																																																																																																																																																																																																																																																																																																																																																												
LOSS DUE TO CLEAR. & GRUB.	-15,000				15,000																																																																																																																																																																																																																																																																																																																																																																																																																																																																																												
ROCK WASTE IN LIEU OF BORROW				-13,524	-13,524																																																																																																																																																																																																																																																																																																																																																																																																																																																																																												
EARTH WASTE IN LIEU OF BORROW				-932,644	-932,644																																																																																																																																																																																																																																																																																																																																																																																																																																																																																												
ADJUSTMENT FOR ROCK WASTE			-2,705	-2,705																																																																																																																																																																																																																																																																																																																																																																																																																																																																																													
SHOULDER MATERIAL			54,450	54,450																																																																																																																																																																																																																																																																																																																																																																																																																																																																																													
<b>PROJECT TOTALS</b>	<b>1,455,802</b>	<b>18,900</b>	<b>1,534,485</b>	<b>79,538</b>	<b>19,755</b>																																																																																																																																																																																																																																																																																																																																																																																																																																																																																												
EST. TO REPLACE TOP																																																																																																																																																																																																																																																																																																																																																																																																																																																																																																	
SOIL ON BORROW PITS				3,977																																																																																																																																																																																																																																																																																																																																																																																																																																																																																													
<b>TOTAL</b>	<b>1,455,802</b>	<b>18,900</b>		<b>83,515</b>																																																																																																																																																																																																																																																																																																																																																																																																																																																																																													
SAY	1,455,900	18,900		83,600																																																																																																																																																																																																																																																																																																																																																																																																																																																																																													
PAV'T STRUCTURE VOLUME -L-	** 29,956 Cu. Yds.																																																																																																																																																																																																																																																																																																																																																																																																																																																																																																

Figure 13-5 Pavement Alternate Base Course Material typical

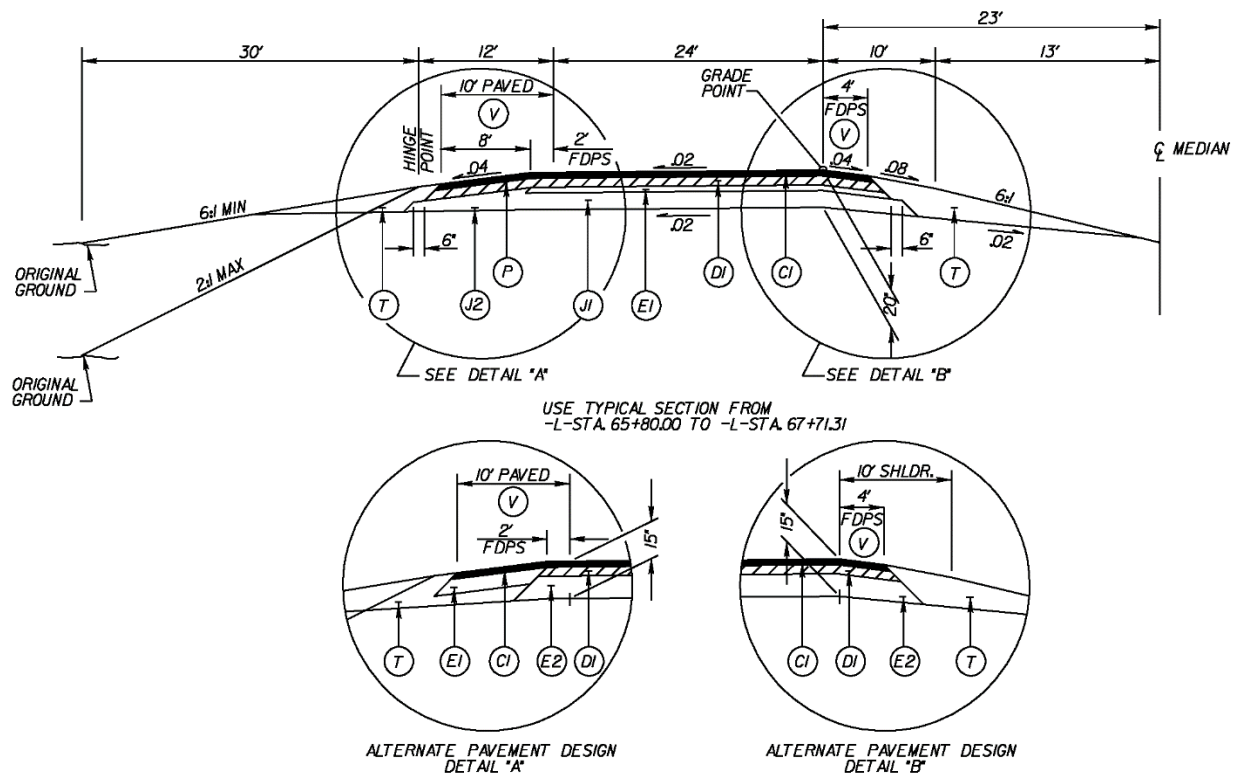

### 13.7.1.3 Guardrail and Guiderail Summaries

The purpose of the guardrail and guiderail summaries is to provide the contractor with the location of all proposed guardrail and guiderail shown in the plans. It also provides more detailed information regarding the location and layout of the proposed guardrail/guiderail than can be derived from the plan sheets. Some of this information includes the location and type of guardrail, warrant points, the distance from the edge of lane to face of guardrail, the distance from edge of travel lane to shoulder break point, the flare length, and the total width of flare from the begin of the taper to the end of the guardrail.

The guardrail summary also provides information related to any guardrail removal, temporary guardrail, and type and number of impact attenuators required on the project. Do not combine temporary guardrail with the permanent guardrail in the summaries. Permanent and temporary guardrail have unique pay items which require them to be listed separately on the guardrail summary sheet. If the project has multiple traffic control phases, investigate whether relapping guardrail (Section 869 of the Standard Specifications) is needed.

To properly estimate the guardrail, pay items and provide the necessary information for the contractor to install the guardrail properly, it is critical to fill out the guardrail summary accurately and completely.

Refer to RDM Part I Chapter 6 for additional guidance on guardrail design.

A brief explanation of critical information is provided below.

- **Warrant point:** Typically represents a fill warrant or rigid obstacle warrant (bridge rail, interior bent, fixed hazards, etc.)



- “N” distance from edge of lane: Distance from the edge of lane to the face of guardrail
- Total shoulder width: Distance from the edge of travel lane to the shoulder break point. The total shoulder width should correspond to the widths shown on the typical section and cross section
- Flare length: Distance from the last section of parallel guardrail to the end of the guardrail
- W: Total width of the flare from the begin of the taper to the end of the guardrail

Refer to the [Example Guardrail Summary](#) provided by NCDOT.

Cable guiderail is typically installed on median divided highways with median widths of 46 feet and greater with 6:1 or flatter slopes. The guiderail summary will show station, location, length, and the number of cable guiderail anchors.

Refer to the [Example Cable Guiderail Summary](#) provided by NCDOT.

List all guardrail and guiderail related pay items in their respective summary.

#### 13.7.1.4 Fence Summary

A fence summary is only required for chain link fence in urban areas, but the roadway designer has the option to include a summary for woven wire fence. Include chain link and woven wire fence summaries when both chain link and woven wire fence are included in the plans. At the engineer’s discretion, a fence summary may be added to help clarify the location and type of fencing to be installed on the project. Refer to Example [Chain Link Fence and Woven Wire Fence Summaries](#) provided by NCDOT.

Refer to RDM Part II Chapter 14 Section 14.6 for additional guidance on control of access fencing.

#### 13.7.1.5 Pavement Removal/Breaking of Existing Pavement Summaries

The purpose of the pavement removal/breakup summary is to provide the contractor with the locations and quantities for the removal of existing asphalt and concrete pavements and the breaking of existing asphalt and concrete pavements. Please note that there are separate pay items for “Removal of Existing Asphalt Pavement,” “Removal of Existing Concrete Pavement”, “Breaking of Existing Asphalt Pavement”, and “Breaking of Existing Concrete Pavement”. It may be difficult to determine the location and quantity of pavement removal/breakup from the plan view since pavement removal is only crosshatched on the plan view outside the slope stake lines. Include all quantities of pavement removal and breaking of existing pavement within the project limits in the summaries. Use cross sections to help determine the limits of pavement removal and breakup. The [NCDOT Standard Specifications for Roads and Structures](#) states that existing pavement should be broken up rather than removed when the existing pavement is located under the proposed embankment and the depth of the proposed embankment is greater than 1-foot exclusive of the base and pavement. Simply stated, the depth from the proposed subgrade to the top of the existing pavement should be greater than one foot for the pavement to be broken up and left in place.

#### 13.7.1.6 Shoulder Drains Summary

Shoulder drains are typically installed on projects with high type Portland Cement concrete pavement designs. The information necessary to complete the shoulder drain summary will be provided by the State Pavement Design Engineer in the Materials and Tests Unit. The State



Pavement Design Engineer will provide shoulder drain recommendations in the Pavement Design. The roadway designer is responsible for creating a shoulder drain summary based on these recommendations. A shoulder drain detail will also be placed with the typical sections. Refer to the [Example Shoulder Drain Drains Summary](#) provided by NCDOT.

### 13.7.2 Drainage Summaries (3D-Series)

Drainage items are summarized on standard drainage summary sheets, which outline detailed drainage information. The classification, size, and quantity of pipe by location are referenced on the drainage summary sheets. The hydraulics engineer is responsible for preparing and submitting the drainage summaries to the roadway designer for inclusion in the roadway plans as 3D-Series plan sheets.

The hydraulics engineer is responsible for the permanent numbering of things such as drainage structures, pipe system outlets, pipe collars, elbows, cross pipes, and side drainpipes, on the plans. Do not renumber the drainage structures on the plans.

There are two different drainage summary sheets, one for statewide tier facilities and one for regional/subregional tier facilities. The regional/subregional tier drainage summary sheets will have columns for drainage pipe and side drainpipe. The use of the drainage pipe pay items is limited to pipes located on regional and subregional tier facilities. Statewide tier facilities will have a statewide tier drainage summary sheet and will not use the drainage pipe pay items but will specify only the side drainpipe pay items. Separate drainage summaries are required for pipes greater than 54 inches in diameter and for pipes 48 inches and under.

For cross drain pipes under high type pavement and special situations, the hydraulics engineer will provide pipe classifications. High type pavement is defined as any Portland Cement concrete pavement or asphalt concrete pavement that is 2 inches or greater in thickness.

The hydraulics engineer may also submit a stormwater control measure summary table with the drainage summary. The summary will list stormwater control measures (bioretention basins, bioswales, hazardous spill basins, level spreaders, preformed scour holes, etc.) from the drainage design. The purpose of the stormwater control measure summary table is to provide a list of measures that will need to be inspected both during and after construction.

The following drainage summary content is intended to reside on the Hydraulics Unit website in the near future. This content will remain in the RDM until the Hydraulics Unit website is updated.

#### 13.7.2.1 Masonry Drainage Structures

The height of the drainage structures is measured vertically to the nearest tenth of a foot from the top of the bottom slab to the top of the wall. Special design junction boxes or manholes will be required if the depth of fill does not fall within the range specified in the [NCDOT Roadway Standard Drawings](#). See Figure 13-6 for an example of computing quantities of masonry drainage structures.

#### Drainage Structures 5 Feet and Under in Height

A drainage structure which incorporates an opening for circular pipe not exceeding 48 inches in diameter is measured and paid for on a per each basis up to a height of 5 feet at the contract price per each for Masonry Drainage Structures.

### Drainage Structures Over 5 Feet and Up to 10 Feet in Height

The portion of a drainage structure from 5.1 feet up to and including 10 feet is figured and paid for at the contract unit price per linear foot for Masonry Drainage Structures.

### Drainage Structures Over 10 Feet in Height

The portion of the drainage structure above 10 feet is measured and paid for at 1.3 times the contract unit price per linear foot for Masonry Drainage Structures.

### Drainage Structures for Circular Pipe Over 48 Inches in Diameter or Pipe Arch of Any Size

Any masonry drainage structure which incorporates an opening for circular pipe exceeding 48 inches in diameter, or for pipe arch of any size, is measured and paid for on a volume basis. The quantity of masonry to be paid for is the number of cubic yards of cast-in-place concrete, brick, or precast masonry which has been incorporated into the structure. These quantities are provided in the [NCDOT Roadway Standard Drawings](#).

### Median Drop Inlets (2GI)

Median drop inlets are typically used in roadway ditches and along shoulder and expressway gutters. The grates used are separate pay items and depend on the type of facility.

- Narrow Slot Grates ([NCDOT Roadway Standard Drawings](#), Std. Nos. 840.24 and 840.29):
  - Use on non-controlled access projects and projects with heavy pedestrian traffic.
  - Use on controlled access projects at locations where pedestrian traffic is anticipated.
- Wide Slot Grates ([NCDOT Roadway Standard Drawings](#), Std. Nos. 840.20 and 840.22):
  - Use on controlled access projects where pedestrian traffic is not anticipated.

### Traffic Bearing Drop Inlets

Use traffic bearing drop inlets within 4 feet of travel lanes since there is potential for vehicular traffic over them. If the inlets are located entirely within a concrete traffic island, they do not need to be traffic bearing.

Refer to [NCDOT Roadway Standard Drawings](#), Std. Nos. 840.35 or 840.36.

Use steel frame and flat steel grates ([NCDOT Roadway Standard Drawings](#), Std. No. 840.37) with traffic bearing drop inlet ([NCDOT Roadway Standard Drawings](#), Std. No. 840.36) on controlled access projects where traffic bearing drop inlets are needed, and pedestrian traffic is not anticipated. The NCDOT Traffic Safety Unit or the hydraulics engineer may specify other locations where steel frame and grates must be used due to other special considerations such as in a travel lane. Bicycle safe frame and grates are required when pedestrian and bicycles need to be accommodated. Obtain the necessary special detail from the [State Plans and Standards Engineer](#).

### Standard Catch Basins

Refer to [NCDOT Roadway Standard Drawings](#), Std. Nos. 840.01 or 840.02.

- Use type “E”, “F”, or “G” grates ([NCDOT Roadway Standard Drawings](#), Std. No. 840.03) on standard catch basins unless specified otherwise by the Hydraulics Unit and discussed on field inspection with Division personnel.
- Standard catch basins are suitable for use adjacent to travel lanes when placed in 2-foot 6-inch curb and gutter.

### Example for Computing Quantity of Masonry Drainage Structure

For further information on drainage structure depths please refer to the [NCDOT Drainage Box Depths](#) document. See Figure 13-6 for an example of calculating the “per each” and “per linear foot” pay items for masonry drainage structures.

Figure 13-6 Example for Computing Quantity of Masonry Drainage Structure

\* TOTAL LIN. FT. FOR PAY QUANTITY SHALL BE COL. "A" + (1.3 X COL. B)

HEIGHT OF STRUCTURES	QUANTITIES FOR DRAINAGE STRUCTURES		
	PER EACH (0' THRU 5.0')	*LIN. FT.	
		A	B
		5.1' THRU 10.0'	10.1' AND ABOVE
4.5'	1	-	-
8.0'	1	3	-
15.2'	1	5	5.2
9.0'	1	4	-
18.0'	1	5	8
TOTAL	5	17	13.2
*GRAND TOTAL	5**	35***	

\* 17 + (1.3 X 13.2) = 34.2 LIN.FT.  
SAY 35 LIN.FT.

PAY ITEMS:  
 MASONRY DRAINAGE STRUCTURE 5 EACH \*\*  
 MASONRY DRAINAGE STRUCTURE 35 LIN. FT. \*\*\*

### Allowed Construction Types

Optional types of construction are allowed for catch basins, drop inlets, junction boxes, and manholes. See Table 13-5 for allowed construction types.

Table 13-5 Permitted Construction Type

	Brick	Concrete	Precast	Solid Block
Brick Catch Basin Std. 840.01	✓			✓
Conc. Catch Basin Std. 840.02		✓	✓	
Conc. Open Throat Catch Basin Std. 840.04		✓	✓	
Brick Open Throat Catch Basin Std. 840.05	✓			✓
Conc. Bridge Approach Drop Inlet Std. 840.13		✓		
Conc. Drop Inlet Std. 840.14		✓	✓	
Brick Drop Inlet Std. 840.15	✓			✓
Conc. Grated D.I., Type A Std. 840.17		✓	✓	
Brick Grated D.I., Type A Std. 840.26	✓			✓
Conc. Grated D.I., Type B Std. 840.18		✓	✓	
Brick Grated D.I., Type B Std. 840.27	✓			✓
Conc. Grated D.I., Type D Std. 840.19		✓	✓	
Brick Grated D.I., Type D Std. 840.28	✓			✓
Driveway Drop Inlet Std. 840.3		✓		
*Conc. Junction Box Std. 840.31		✓	✓	
*Brick Junction Box Std. 840.32	✓			✓
Traffic Bearing Junction Box Std. 840.34	✓		✓	✓
Traffic Bearing Grated Drop Inlet Std. 840.35	✓	✓	✓	✓
Traffic Bearing Grated Drop Inlet Std. 840.36		✓		
Spring Box Std. 840.41	✓	✓	✓	✓
Manhole Std. 840.51, 804.52, or 840.53	✓		✓	✓

### 13.7.2.2 Drainage Pipes

Different pipe materials can be used depending on the road classification (interstate, primary, secondary), and specific site conditions such as abrasion, environmental factors, soil resistivity, pH, high ground water, and special loading conditions.

Refer to the Hydraulic Unit's [NCDOT Pipe Material Selection Guide](#) document for further information.

Where specific site conditions such as low cover over pipe or other topographical constraints exist, the hydraulics engineer may specify pipe shapes not listed in the [NCDOT Pipe Material Selection Guide](#). These include corrugated steel or corrugated aluminum pipe arches, structural plate steel pipes, and elliptical and arched concrete pipes.

### 13.7.2.3 Other quantities

The hydraulics engineer quantifies and specifies the class of rip rap used for drainage. Note that the hydraulics engineer labels rip rap for drainage, geotextile for drainage, and drainage ditch excavation quantities for channels and pipes on the plan sheets. The roadway designer is responsible for quantifying and adding these pay items to the final estimate.

Refer to the [NCDOT Standard Specifications for Roads and Structures](#) and the [NCDOT Roadway Standard Drawings](#) for further information on other drainage pay item quantities such as elbows, endwalls, pipe removal, junction boxes, manholes, sluice gates, preformed scour holes, energy dissipators, and riser pipes.

### 13.7.3 Geotechnical Summaries (3G-Series)

The geotechnical engineer is responsible for completing the geotechnical summary tables and placing a Microsoft Excel spreadsheet of the summary with the geotechnical project files. If there is more than one geotechnical product (pavement design investigation, subsurface investigation, subsurface investigation addendum, etc.), there may be more than one geotechnical summary table (Excel file) provided. Confirm all geotechnical summary tables are included in the roadway plans. The Excel file(s) can be found on the project's preconstruction team site in the geotechnical disciplines folder. Consolidate all geotechnical tables onto a single geotechnical summary sheet. The roadway designer is responsible for creating the geotechnical summary (3G-Series sheet) based on the completed tables found in the Excel file(s) provided by the Geotechnical Engineering Unit. The roadway designer may need to remove any unused (blank) summary tables and reformat the tables in the sheet for inclusion in the roadway plans. Common geotechnical summary tables include:

- Subsurface drainage (subsurface drains, underdrains and/or blind drains)
- Rock plating
- Reinforced soil slopes
- Bridge waiting periods
- Embankment waiting periods
- Geotextile for subgrade stabilization
- Settlement gauges
- Horizontal drains
- Surcharge and surcharge waiting periods
- Aggregate subgrade/stabilization

### 13.7.4 Parcel Index Sheet (3P-Series)

A parcel index sheet references the parcel numbers, property owner names, and plan sheet numbers where the parcels are located. Parcel index sheets are required on all projects with two or more plan sheets. Refer to the [Example Parcel Index Sheet](#) provided by NCDOT.

## 13.8 Plan and Profile Sheets

The design information shown on the plan and profile sheets should provide the contractor and Resident Engineer with all the basic information needed to construct the project. Plan and profile sheets generally convey the following information: horizontal and vertical alignments, existing and proposed roadways, proposed slope stake lines, proposed drainage pipes, ditches, structures, existing topographic information, and proposed right of way necessary for the roadway construction.

Plan and profile sheets are normally shown on separate sheets but may be shown on the same sheet when conditions allow. It is important that the horizontal and vertical alignments tie to the final survey alignments. Standard plan and profile sheet cells have been created to automate and standardize the preparation of the roadway plans.

### 13.8.1 Plan Sheets

Plan sheets show existing features and proposed design elements as shown from an aerial view (or plan view). The purpose of the plan sheet is to show the horizontal alignments and use text and symbols to describe the work to be performed. Note that the level of detail provided varies depending on the stage of project development with more detail being provided in the final construction plans.

Refer to the applicable QA/QC checklists and the [NCDOT Review List for Final Construction Plans](#) for additional information.

The following basic information is typically included on a plan sheet:

- TIP number
- Sheet number
- Roadway and hydraulics engineer seals
- Begin and end project stations
- Begin and end construction stations
- Existing pavement width and type
- Proposed construction elements
- Horizontal alignment and horizontal curve data
- Centerline stationing and tangent bearings
- Superelevation
- Intersecting roads and driveways
- Proposed drainage
- Location features (north arrow, right of way lines, easements, county lines, municipal boundaries, etc.)

- Final survey
- Detour design speed

Show structural sheet number and profile sheet number cross references on the plan sheets when applicable. Use special detail and detour sheet cross references as needed to provide clarity to the plans.

### 13.8.2 Profile Sheets

A profile illustrates the grade of the existing and/or proposed roadway alignment. The following basic information is typically included on a profile sheet:

- Begin and end stations
- Vertical alignment and vertical curve data
- Elevation and station references
- Scale
- Existing groundline along the horizontal alignment
- Hydraulic data for bridges, culverts, and cross pipe (information to be provided by the Hydraulics Unit)
- Undercut excavation when specified by station range in the Geotechnical Recommendations for Design and Construction.

Note: Do not show shallow undercut on the profile sheets.

Denote any structural excavation as a “Str. Pay Item” on the profile sheet and do not include when calculating the unclassified excavation.

## 13.9 Cross Sections

The cross section sheets depict the existing ground cross sections and the proposed templates of the roadway to be constructed. Individual cross sections are typically cut at 50-foot intervals. The primary purpose of the cross section sheets is to aid the designer in estimating the earthwork quantities, but they are also used by the contractor and the resident engineer as a reference during the construction of the project. Follow the cross section listing in the [NCDOT Review List for Final Construction Plans](#) when preparing the cross sections to ensure that all required information is shown on the plans.

Include a cross section index as a cover sheet to the cross sections when there are more than two alignments that require cross sections.

In addition to the cross section templates and cross section index, create a cross section summary sheet. Place the cross section summary after the cross section index sheet or as a cover sheet to the cross section templates if there is no index sheet. The cross section summary displays the earthwork volumes broken down for each cross section interval. Refer to the Excel file entitled “Earthwork XSC Volume Summary” found on the NCDOT Roadway Design Technical Resources Website at [NCDOT Roadway Design - CADD](#). Earthwork volumes (unclassified excavation, undercut, and embankment) by station range are shown on the cross section summary sheet. Do not apply the shrinkage factor to the embankment volumes.

Add the following notes to the cross sections, as needed.



### 13.9.1 Cross Section Note for Lump Sum Grading

When the lump sum grading pay item is included in the final construction estimate, add the following note on the cross section summary sheet or first cross section template plan sheet and with the Earthwork Summary (3B-Series plan sheet). Both notes should be identical.

“Note: Approximate quantities only. unclassified excavation, borrow excavation, shoulder borrow, fine grading, clearing and grubbing, breaking of existing pavement, and removal of existing pavement will be paid for at the contract lump sum price for Grading.”

Revise the note to remove pay items that are not applicable to the project. If the cost of any one of the items listed on the lump sum grading note (excluding clearing and grubbing and fine grading) exceeds 50 percent of the total cost of the lump sum grading, remove that item from the note and include it as an individual pay item in the contract.

Refer to RDM Part II Chapter 15 Section 15.4.4 and the NCDOT Grading Lump Sum Calculation of Quantities Sheet.

### 13.9.2 Cross Section Note for Projects that do not Specify Lump Sum Grading

When the lump sum grading pay item is not included in the final construction estimate, add the following note on the cross section summary sheet or first cross section template plan sheet and with the Earthwork Summary (3B-Series plan sheet)

“Note: Quantities are approximate only. The Resident Engineer will use methods including but not limited to recross-sectioning, truck measurements, and aerial surveys to compute final quantities which the contractor will be paid.”

This note may be modified at the request of the Division. The roadway designer shall receive written approval from the Division prior to modifying the note.

### 13.9.3 Backfill for Undercut Note

Include a backfill for undercut note on the cross section summary sheet. At the discretion of the roadway designer, the embankment column may include the material needed to backfill any undercut specified by station range. This note is needed to clarify whether the embankment column includes or does not include backfill for undercut. Show one of the following notes.

“Note: Embankment column does not include backfill for undercut.”

Or

“Note: Embankment column includes backfill for undercut.”

The note Embankment column does not include backfill for undercut is more commonly used and ensures that the earthwork quantities needed to backfill any undercut areas are clearly represented on the earthwork balance sheet. Adjust embankment quantities on the cross section summary when the embankment column includes backfill for undercut. To avoid common errors in the cross sections, ensure the following items are addressed prior to submittal to encountered during plan review include:

- ~~Not labeling~~ Label the cut and fill slopes on the cross section templates
- ~~Not comparing~~ Compare the total earthwork volumes shown on the cross section summary to the volumes shown on the earthwork balance sheet and on the earthwork summary
- ~~Not listing~~ List the undercut volumes by station range on the cross sections summary when specified in the geotechnical recommendations

- ~~Not labeling~~ Label undercut and/or shallow undercut when specified by station range in the geotechnical recommendations. Shallow undercut recommended by station for removal should be shaded on the cross sections and shown on the typical sections, but not the profile. Standard undercut will always be shown on the profile, even if undercut areas do not cross the centerline of divided or undivided facilities.
- ~~Showing~~ Do not show subsurface information from the investigation (existing rock lines or unsuitable unclassified excavation) on the cross sections
- ~~Not referencing~~ Reference the correct backfill for undercut note on the cross section summary sheet(s)
- ~~Not listing~~ List the appropriate grading note on the cross section summary sheet or cross section sheet
- ~~Not showing~~ Show the existing centerline grade elevation on each cross section

## 13.10 Roadway Supporting Documentation

Store all project documentation on the individual projects SharePoint team site. It is critical that the key RDY property be used to identify all documents that should be permanently preserved. The information found in the key supporting documents are essential for preparing a complete set of roadway construction plans.

Refer to RDM Part II Chapter 12 Section 12.4 for additional guidance on Preconstruction Best Practices when accessing the project team sites on Connect NCDOT.

~~Typical roadway key documents that should have the key RDY value set include, but are not limited to, the following:~~

- ~~• All approvals and denials~~
- ~~• Construction cost estimate~~
- ~~• Information related to any pending legal actions~~
- ~~• Correspondence providing historical or background information on controversial matters~~
- ~~• Justification studies for special or unusual matters~~
- ~~• Design exception approval~~
- ~~• Design decisions~~
- ~~• Location and design approval (LADA)~~
- ~~• Any other item that, in the judgment of the project manager or roadway designer, should be retained~~

Typical roadway supporting documents that should be placed in the LET Preparation/Final Plans/Roadway Supporting Documents Document Set on the project's Preconstruction Team site ~~in the Roadway Supporting Documents Document Set~~ include, but are not limited to, the following:

- Calculation of quantity package
- Final Estimate – Quantities only (Excel or PDF)
- Cost based estimate quantity breakdown sheet

- [Roadway Force Account Estimates \(if applicable\)](#)
- ~~Earthwork Balance Sheet (PDF)~~ [Earthwork Log Files, Computation, and Balance Sheet \(separate files, PDF\)](#)
- Index of Sheets (8" x 11" PDF)
- [List of Roadway Standard Drawings and General Notes \(EXCEL\)](#)
- [200 Series R/W items/Memo \(building removal\)](#)
- [Checklist for Coordination of Roadway and Structure Plans](#)
- Completed Review List for Final Construction Plans

~~The roadway designer is responsible for placing the earthwork balance sheet and other supporting documents in the LET Preparation/Final Plans/Roadway Supporting Documentation folder on the project's Preconstruction Team site.~~

Typical key documents and supporting documentation from other disciplines that the roadway designer may need to reference [in the LET Preparation/Final Plans/Correspondence Document Set on the project's Preconstruction Team site](#) include, but are not limited to, the following:

- [Field Inspection correspondence \(may be placed in the team collaboration library\)](#)
- [Approved Design Criteria](#)
- Pavement design
- ~~Memoranda on demolition and removal (Section 200 Letter from the Right of Way Unit)~~
- Geotechnical reports
  - Geotechnical Recommendations for Design and Construction
  - Geotechnical Recommendations for Pavement and Subgrade
  - Roadway Subsurface Inventory
  - Pavement and Subgrade Investigation Report
- Foundation recommendations
- Bridge and culvert survey reports
- Traffic reports and forecasts
- Municipal agreements and betterments
- Planning document
- Agency coordination
- Right of Way letter sent to Right of Way Unit (Letter of Authorization if federally funded)
- Consultations
- Natural Resource Technical Report (NRTR)

[Reference the PS&E Checklist to ensure all necessary documents are submitted to the Final Plans Library on SharePoint.](#)

### 13.10.1 Design Decision Documentation

Design decision documentation is a tool to inform of significant design decisions made throughout the life of the project. The design decision documentation should be maintained on ProjectWise and include a date, engineer of record and the description of the major design decision. The documentation should be included with the submittals and as requested by NCDOT Project Manager. The content of documentation can include topics such as:

- Any unusual or non-typical design element that deviates from NCDOT design guidance to inform a reviewer why something was done.
- Any significant design decision made to avoid or minimize impacts to a particular structure or feature, either existing or proposed.
- Any significant design decision that alters the design in such a way that documentation can inform project stakeholders in the future as to when and why the design change was made.

Note: Documentation of commitments or changes already documented elsewhere is not required (for example: Right of way revision design changes).

## 13.11 Roadway Submittal Guidelines

### 13.11.1 General information for Submittal Guidelines

#### 13.11.1.1 Project Content

These guidelines were established to aid in understanding the expectations of the North Carolina Department of Transportation (NCDOT) Roadway Design Unit as projects are being developed using the Project Delivery Network (PDN). The PDN is a scalable and flexible support document that provides consistency and enables the project team to improve efficiency and quality. During the scoping process, the project team may identify strategies which could require an adjustment to the deliverables as shown.

While a roadway designer is active in Stage 1 (Project Initiation), the guidance concerning the Express Design deliverables in this stage has been developed by the Feasibility Studies Unit and can be found in the Project Delivery Network (PDN) documentation for 1FS1. Information on activities for Stage 2 (Alignment Defined), Stage 3 (Plan in Hand) and Stage 4 (PS & E/Let) is contained in this document. A project schedule will be developed for each project that will include dates and durations for tasks, deliverables and key milestones that align with the PDN.

All roadway design project submittals shall be submitted to the NCDOT Project Manager.

#### 13.11.1.2 Folder Structure and File Maintenance

NCDOT has designated ProjectWise as the official repository for storage of CADD files. The following guidance will provide further detail for each submittal in terms of placement of supporting documents and PDF deliverables.

### 13.11.2 Project Delivery Network Submittal Guidelines

#### 13.11.2.1 Design Criteria Submittal

The roadway designer shall review the Project Scoping Report for any Complete Streets or other coordination that may need to be incorporated into the design criteria. The roadway

designer shall develop and submit a PDF copy of the design criteria with the associated typical sections to the Roadway Design document library on SharePoint for review. The design criteria should include columns for each alignment, including additional mainline sections if there are varying design speeds, traffic volumes or facility types which would yield different values, temporary detours, Y lines and ramps. If ramps or Y lines have the same criteria, they can be shown together in a single column. A Phase Submittal Form with a list of the contents of the submittal package will accompany the design criteria. This can be found on the NCDOT Roadway Design Resources website. Refer to RDM Part I Chapter 2 Section 2.1 for more information about Design Criteria.

Prior to beginning the final design, the roadway designer shall submit detailed design criteria for approval by the Roadway Design Unit's Design Development and Support Group Lead or appropriate Division personnel.

### **13.11.2.2 Meeting/Hearing Maps for Public Involvement Submittal**

The roadway designer shall submit PDFs of the maps for public involvement (design public meeting/hearing and/or corridor public hearing) to the Human Environment document library on SharePoint. All electronic files associated with producing the PDFs of the maps shall also be made available on ProjectWise. A Phase Submittal Form with a list of the contents of the submittal package will accompany the public meeting/hearing maps. This can be found on the NCDOT Roadway Design Resources website. Refer to RDM Part II Chapter 12 Section 12.6 for more information on the format of these maps.

### **13.11.2.3 Design Recommendation Plan Submittal**

The roadway designer shall use the Express Designs developed in Stage 1, if available, as the foundation to establish the most cost-effective horizontal and vertical alignments using final survey information as the base. Interchange and/or intersection configurations should be coordinated with the Traffic Operations Analysis Technical Memorandum. Refer to RDM Part I Chapter 9 for more information about Interchanges.

The roadway designer shall submit PDFs of the plans and cross sections to the Roadway Design document library on SharePoint for review. All electronic files associated with producing the PDFs of the plans and cross sections should be made available on ProjectWise. The calculation of quantity sheets, earthwork balance card and electronic files used to generate quantities for the construction estimate request shall also be placed on ProjectWise. For more information on the format of these PDFs and electronic file submittals, see Section 13.11.3.

The roadway designer shall coordinate with the NCDOT Project Manager to determine whether feedback on the plans from the technical disciplines/Units and appropriate Division personnel will be provided at a Design Recommendation Plans Set Review Meeting or during a comment period. Once comments have been adequately addressed, the design recommendation plan set will be approved by the Roadway Design Unit's Design Development and Support Group Lead or appropriate Division personnel. The NCDOT PM will distribute the plans to the appropriate technical leads to begin their work in earnest.

The roadway designer shall prepare this submittal to include but not limited to the following:

- Phase Submittal Form with a list of the contents of the submittal package (see the NCDOT Roadway Design website).
- Title Sheet should be labeled as the Design Recommendation Plan Set.
- Typical Sections including:

- Pavement schedule based on the preliminary or final pavement design recommendations, if available
- Typical section of the bridge with a note to See Structure Plans for Construction.
- Typical section under the bridge if it is over a motorized or non-motorized transportation facility.
- Plan Sheets with Horizontal Design for all Alignments
  - Proposed design for the roadway, intersections, and interchanges (if applicable)
  - Horizontal curve data placed on the corresponding plan sheets
  - The beginning and end of each proposed alignment shall tie to the best-fit alignment provided by Location and Surveys.
  - A horizontal and vertical alignment shall be provided for existing driveways which are re-aligned or any driveway with grades greater than 10%.
  - Preliminary right of way and easement limits. The inclusion of right of way and control of access monuments or station and offset flags are not required for this submittal.
  - Proposed guardrail design
  - Slope stake lines that encompass all proposed construction limits
  - Proposed Sag and Crest locations identified on plan sheets as well as existing contours reflected on the set of plans that will be used by the NCDOT Hydraulic Design Reviewer. This information should be removed from the approved Design Recommendation Plan Set.
  - Superelevation with arrows shown and increment dimension. The superelevation achieved and runoff lengths for each curve should be noted under the curve data. The design speed should be noted if the curve does not meet the proposed design speed.
  - Final Survey file information with appropriate levels turned off (i.e. top and invert elevations, seat elevations, culvert table, point numbers).
  - Delineation of wetlands and jurisdictional streams.
- Profile Sheets with Vertical Design for all alignments
  - Existing and proposed profiles for the mainline and intersecting roads.
  - Vertical curve data contained on the profile sheets. The design speed should be noted when the vertical curve does not meet the proposed design speed.
  - All Y line grades shall have mainline stations & offsets and edge of pavement elevations shown at the tie points.
  - If the project requires a resurfacing grade, this should be submitted along with control point calculations for review.
- Cross Sections



- Cross sections shall be shown for all proposed construction and must be generated using the 3D model. Station labels shall be provided below the cross section templates.
- Superelevation and cross slopes shall be labeled on all cross section templates.
- Cross sections shall contain grid lines at (5 or 10) foot intervals.
- Grid combinations shall be discussed and approved by the appropriate NCDOT staff prior to preparing cross sections.
- Bar scale shall be provided on all cross section sheets.
- If it has been determined that an on-site detour will be utilized, then the cross sections shall include temporary slopes for the detour.
- Correspondence from the Hydraulic Engineer stating minimum grade required to achieve hydraulic design criteria or that the proposed grade is not hydraulically controlled.
- Completed Design Exception Checklist

If any of controlling design criteria elements are not in compliance with AASHTO and/or the Roadway Design Manual, the roadway designer should coordinate with the State Roadway Design Engineer if centrally managed or the Division Engineer's designee if division-managed to 1) evaluate if the design exception is acceptable and 2) to determine the appropriate documentation method.
- Design Exception Request Package (if applicable)
- Preliminary Earthwork Summary.
- Sight Distance Calculations with supporting documentation at intersections, bridges, median barrier, retaining walls and other obstructions (if applicable)
- Vertical Clearance Calculations (if applicable)
- Gore Calculations for Ramp/Loop Interchange Designs (if applicable)
- Shear Point Diagram (if applicable)
- Retaining Walls
  - Provide retaining wall horizontal alignment. (if applicable)
  - Develop preliminary retaining wall envelopes. (if applicable)
- Service Roads

The Project Scoping Report should identify/evaluate the need for service roads based on the information available in Stage 1 (Project Initiation). However, the roadway designer shall re-evaluate the design for this submittal to ensure there are no additional land-locked properties that could potentially benefit from a service road. A service road study shall be completed and approved before any service road is included in the plans.
- On-Site Detour Alignments

If it has been determined that an on-site detour will be utilized after discussions with the project team, then the horizontal and vertical alignments shall be provided on the plan sheets.
- Preliminary Construction Phasing Concept

This is a narrative to demonstrate an understanding of how the project can be constructed as designed. Coordination with the Work Zone Traffic Engineer should be done for highly complex projects.

- Verification Checklist for Adjacent Projects, if applicable (see the NCDOT Roadway Design website).
- The roadway designer shall provide a construction estimate request, the calculation of quantities, earthwork balance card and other supporting files based on the Design Recommendation Plan Set.
- Completed Quality Control Checklist for the Design Recommendation Plan Set.
- Responses to NCDOT's Quality Assurance comments if a resubmittal is required.

#### **13.11.2.4 Field Inspection Plan Set**

The Field Inspection Meeting allows the project team to review the plans from the perspective of all technical disciplines and the Division to identify any issues that need to be resolved prior to finalizing the proposed right of way and easements required for acquisition. Prior to submission of the Field Inspection Plan Set, the proposed hydraulic design, approved Culvert and/or Bridge Survey Report(s), approved Preliminary General Drawings and identification of utility easements should be completed.

The roadway designer shall submit PDFs of the Field Inspection Plan Set with cross sections to the Roadway Design document library on SharePoint. All electronic files associated with producing the PDFs of the plans and cross sections as well as the development of the calculation of quantities and construction estimate request shall be made available on ProjectWise. The roadway designer will coordinate with the NCDOT Project Manager to ensure plans for the meeting are distributed to the technical disciplines/Units and Division far enough in advance, typically 1 month, to allow time for review by all attendees. For more information on the format of the PDFs and electronic file submittals, see Section 13.11.3.

A typical distribution to the Division includes six (6) sets of plans, two (2) sets of cross sections and Field Inspection questions. The roadway designer should coordinate with the NCDOT Project Manager and Division Construction Engineer to determine if adjustments to the number of sets are needed. If hard copies are required, a two-day mail service is recommended for distribution of the hard copies to the Division.

The roadway designer shall prepare this submittal to include but not limited to the following:

- Phase Submittal Form with a list of the contents of the submittal package (see the NCDOT Roadway Design website).
- Title sheet should be labeled as the Field Inspection Plan Set.
- Plans should contain all design elements from the Design Recommendation Plan Set with any updated designs based on recommendations from other technical disciplines and the associated design calculations.
- Pavement design recommendations have been incorporated into the typical section sheets.
- Proposed right of way and easements are to be labeled on the plans.
- All right of way and easement points will be flagged with an offset station and distance. It is recommended that permanent monuments and markers not be placed on property lines. If for some reason this becomes a necessity, the roadway designer shall coordinate with the



Locating Engineer to ensure the property line is adequately tied down for legal property transfer.

- Utility easements (permanent and temporary) shall be shown as requested by the Utility Coordinator.
- Temporary easements shall be shown as requested by the Erosion and Sedimentation Control Engineer.
- The location and size of all drainage structures and systems (proposed and existing) required for complete drainage of the project.
- The location of construction limits including berm or lateral ditches and channel changes shall be shown.
- Details for all drainage ditches shall be included.
- Property lines, existing right of way and existing easements are shown. All parcels affected by right of way acquisition must show property owner names, deed book information and parcel numbers.
- The existing right of way lines of public roads within the project limits.
- Roadway Geotechnical Recommendations shall be incorporated into the Roadway plans.
- The Engineer shall provide a construction estimate request with quantity calculations so it may be provided to the Division Construction Engineer.
- Earthwork Summaries. (Additional summaries if applicable; guardrail, guiderail, barrier, pavement removal, pavement breaking, curb and gutter, shoulder berm gutter, expressway gutter, fencing, geotechnical, etc.)
- A copy of the current field inspection questions shall be provided to the Division Construction Engineer to be completed by the Division after the meeting. A copy can be found on the NCDOT Roadway Design Resources website. If the roadway designer has other questions for which they need responses, then they should also be provided to the Division Construction Engineer ahead of the meeting.
- Verification Checklist for Adjacent Projects, if applicable (see the NCDOT Roadway Design website).
- If the scope includes development of quantity calculations for a construction estimate, the Roadway Design Engineer shall provide a construction estimate request, the calculation of quantities, earthwork balance card and other supporting files based on the Field Inspection Plan Set.
- Completed Quality Control Checklist for Field Inspection Plan Set.
- Responses to NCDOT's Quality Assurance comments if a resubmittal is required.

### **13.11.2.5 Right of Way Plan Set Submittal**

The roadway designer will make updates to the field inspection plan set based on the comments and minutes from the field inspection and responses from the Division to the field inspection questions so that the plans are ready for the beginning of right of way acquisition.

The roadway designer shall submit PDFs of the plans with cross sections to the Roadway Design document library on SharePoint for review. All electronic files associated with producing

the PDFs of the plans and cross sections as well as the development of the calculation of quantities and construction estimate request shall be made available on ProjectWise.

The roadway designer shall submit/distribute PDFs of the plans with cross sections to the Roadway Design document library on SharePoint. All electronic files associated with producing the PDFs of the plans and cross sections as well as the development of the calculation of quantities and construction estimate request shall be made available on ProjectWise. For more information on the format of the PDFs and electronic file submittals, see Section 13.11.3.

The Quality Control Checklist for the Right of Way Plan Set provides a comprehensive guide for this submittal. The roadway designer shall prepare this submittal to include but not limited to the following:

- Phase Submittal Form with a list of the contents of the submittal package (see the NCDOT Roadway Design website).
- Title sheet with a Right of Way Plan Set label
- All comments from the Field Inspection are incorporated.
- All design revisions have been incorporated.
- Construction estimate request with updated quantity calculations. (Note: The seeding and mulching quantity must be provided to the Roadside Environmental Unit.)
- Verification Checklist for Adjacent Projects, if applicable (see the NCDOT Roadway Design website).
- If the scope includes development of quantity calculations for a construction estimate, the Roadway Design Engineer shall provide a construction estimate request, the calculation of quantities, earthwork balance card and other supporting files based on the Right of Way Plan Set.
- Completed Quality Control Checklist for Field Inspection Plan Set.
- Responses to NCDOT's Quality Assurance comments if a resubmittal is required.

#### **13.11.2.6 Design Complete Review Meeting Plan Set**

The roadway designer shall submit PDFs of the Design Complete Review Meeting Plan Set with cross sections to the Roadway Design document library on SharePoint. All electronic files associated with producing the PDFs of the plans and cross sections as well as the development of the calculation of quantities and construction estimate request shall be made available on ProjectWise. The roadway designer will coordinate with the NCDOT Project Manager to ensure plans for the meeting are distributed to the technical disciplines/Units and Division far enough in advance, typically 1 month, to allow time for review by all attendees. For more information on the format of the PDFs and electronic file submittals, see Section 13.11.3.

A typical distribution to the Division includes six (6) sets of plans, two (2) sets of cross sections and Field Inspection questions. The roadway designer should coordinate with the NCDOT Project Manager and Division Construction Engineer to determine if adjustments to the number of sets are needed. If hard copies are required, a two-day mail service is recommended for distribution of the hard copies to the Division.

The roadway designer shall prepare this submittal to include but not limited to the following:

- Phase Submittal Form with a list of the contents of the submittal package (see the NCDOT Roadway Design website).

- Title sheet with a Plan in Hand Plan Set label
- All design and right of way revisions have been incorporated.
- Construction estimate request with updated quantity calculations.
- Verification Checklist for Adjacent Projects, if applicable (see the NCDOT Roadway Design website).
- If the scope includes development of quantity calculations for a construction estimate, the Roadway Design Engineer shall provide a construction estimate request, the calculation of quantities, earthwork balance card and other supporting files based on the Right of Way Plan Set.
- Completed Quality Control Checklist for Field Inspection Plan Set.
- Responses to NCDOT's Quality Assurance comments if a resubmittal is required.

### **13.11.2.7 Final Plan Set Submittal**

The roadway designer shall submit PDFs of the plans with cross sections and supporting documents in the Let Preparation/ Final Plans document library on SharePoint. All electronic files associated with producing the PDFs of the plans and cross sections and development of the calculation of quantities and construction estimate shall be made available on ProjectWise. For more information on the format of the PDFs and electronic file submittals, see Section 13.11.3.

The roadway designer shall prepare this submittal to include but not limited to the following:

- Phase Submittal Form with a list of the contents of the submittal package (see the NCDOT Roadway Design website).
- All design and right of way revisions have been incorporated.
- Calculation of Quantity Sheets
- The roadway designer shall input the pay items and quantities into the PIQ tool or AASHTOware, as appropriate.
- Construction Estimate Request form with pay items and quantities for Final Plans, if applicable
- Index of Sheets
- List of General Notes
- List of Standard Drawings
- List of Special Provisions
- Cost Based Estimate Quantity Breakdown
- Determination of Lump Sum Grading Warrants
- Complete copy of the current Review List for Final Plans Checklist (see the NCDOT Contract Standards website).
- Verification Checklist for Adjacent Projects, if applicable (see the NCDOT Roadway Design website).
- Other Roadway Supporting Documents

- Responses to NCDOT’s Quality Assurance comments if a resubmittal is required.

Note: All quantity computations shall be completed using NCDOT’s Calculation of Quantity forms provided on the NCDOT Contracts Resources website, if available.

**Plans for this submittal will NOT be accepted until all the above requirements are met.**

### **13.11.2.8 Sealed Contract Roadway Plans Submittal**

The roadway designer shall provide written responses to all comments provided by the NCDOT’s Contract Standards Unit until they have determined everything has adequately been addressed. Once they have provided the approval to move forward with sealing, the roadway designer shall submit PDFs of the roadway design plans properly formatted for electronic seals and signatures with cross sections in the Let Preparation/ Final Plans document library on SharePoint. All electronic files associated with producing the PDFs of the plans and cross sections and development of the calculation of quantities and construction estimate shall be made available on ProjectWise.

### **13.11.3 Electronic File Submittal Guidelines**

When the roadway designer submits electronic files, they shall include all the files needed for review and reproduction. To ensure compliance with Board Rule 21 NCAC 56.1103(c), all documents which are sealed and the CADD files that contain engineering drawings, specifications or reports shall contain a label which reads, “Documents not Considered Final Unless All Signatures Completed”. This label has been deemed by the North Carolina Board of Engineers and Land Surveyors as substantially the same as the other labels in paragraph 1103(c). The label is a permanent part of the document and will remain valid prior to and after electronic signature.

The roadway designer should also submit all electronic files associated with the engineer’s estimate including, but is not limited to, calculation of quantity spreadsheets, earthwork files and estimate shape design files to ProjectWise.

#### **13.11.3.1 Design File Naming Convention**

The Department uses paperless plan distribution, unless requested otherwise. To that end, the following guidelines shall be adhered to when submitting electronic files:

##### **V8i/Corridor Modeling**

<u>Title Sheet</u>	<u>TIP# RDY TSH.DGN</u>
<u>Symbology Sheet</u>	
<u>Typical Sections</u>	<u>TIP# RDY TYP.DGN</u>
<u>Detail Sheets (if applicable)</u>	
<u>Detour Sheets (if applicable)</u>	
<u>Shear Point Diagram (if applicable)</u>	<u>TIP# RDY SPD.DGN</u>
<u>Drainage Summary Sheets</u>	<u>DDS program</u>
<u>Earthwork Summary Sheet (begin with 1B)</u>	<u>TIP# RDY 1B.DGN</u>
<u>Guardrail Summary Sheet (begin with 1B)</u>	<u>TIP# RDY 1B.DGN</u>
<u>Miscellaneous Summary Sheets</u>	
<u>Parcel Index Sheet (if applicable)</u>	
<u>Design</u>	<u>TIP# RDY DSN.DGN</u>
<u>Right of Way</u>	<u>TIP# RDY ROW.DGN</u>

Plan Sheets	TIP# RDY_PSH#.DGN (use leading 0 for sheets 4 through 9)
Profile Sheets	TIP# RDY_PFL.DGN
Final Survey	TIP# NCDOT_FS.DGN (.pln-logical name)
Wetland File	TIP# NEU_WET or WEX.DGN
Proposed Drainage	TIP# HYD_DRN.DGN
Cross Sections	TIP# RDY_XSC.DGN
Cross Section Sheets	TIP# RDY_XPL.DGN
GPK File	jobrdy.gpk

### **Open Roads Designer**

Title Sheet	TIP# RDY_TSH.DGN
Symbology Sheet	
Typical Sections	TIP# RDY_TYP.DGN
Detail Sheets (if applicable)	
Detour Sheets (if applicable)	
Shear Point Diagram (if applicable)	TIP# RDY_SPD.DGN
Drainage Summary Sheets	DDS program
Earthwork Summary Sheet	TIP# RDY_3B#.DGN
Guardrail Summary Sheet	TIP# RDY_3B#.DGN
Miscellaneous Summary Sheets	
Parcel Index Sheet (if applicable)	
Design	TIP# RDY_ALG.DGN
Right of Way	TIP# RDY_ROW.DGN
Design Supplemental File	TIP# RDY_DSN.DGN
Plan/Profile Sheet Layout	TIP# RDY_PPL#.DGN (use leading 0 for sheets 4 through 9)
Plan Sheets	TIP# RDY_PLS.DGN
Profile Sheets	TIP# RDY_PRS.DGN
Slope Stakes	TIP# RDY_SS.DGN
Final Survey	TIP# LS_FS.DGN (.pln-logical name)
Existing Complex Terrain Models	TIP# LS_ECTM.DGN
Wetland File	TIP# NEU_WET or WEX.DGN
Proposed Drainage	TIP# HYD_DRN.DGN
Cross Section layout	TIP# RDY_XPL.DGN
Cross Section Drawing	TIP# RDY_XSD.DGN
Cross Section Sheets	TIP# RDY_XSS.DGN

For more information, the naming conventions may be found on the [NCDOT CADD Resources for Consultants website](#) and the [NCDOT Roadway Design Resources website](#). For ORD Projects, the file naming will be in accordance with the [Roadway Design Module 1 File Management](#). The Final Survey and Existing Complex Terrain Model files are container files that should be named as above. The associated reference files should be named according to the [NCDOT Location and Surveys Unit ORD Guidelines](#).

### **13.11.3.2 File Format**

To establish uniformity within the Department, all electronic submittals must meet the following requirements:

### Corridor Modeling

- The roadway designer must use the same versions of MicroStation and Geopak as NCDOT.
- All plans must be coordinately correct.
- The NCDOT Design and Computation Manager databases shall be used for all applicable items including plan sheets for project design in MicroStation and Geopak.
- The coordinate geometry point numbering convention must be followed.
- The Geopak Data File Transmittal form must be completed (if applicable).
- Use of all NCDOT Cell Libraries and Leveling DGN Library must be adhered to.

### Open Roads Designer

- The roadway designer must use the current NCDOT CADD Software versions published on the NCDOT CADD Services website.
- The roadway designer must use the current NCDOT workspaces.
- All plans must be coordinately correct.
- Use of all NCDOT Cell Libraries and Leveling DGN Library must be adhered to.

#### 13.11.3.3 Plan Sheets

Per Chapter 21 of the NC Administrative Code Section 56.1103(a), the name, address and license number of the consultant(s) responsible for the roadway, hydraulic and pavement design information shall be placed on all sheets requiring seals and signatures. The inclusion of the consultant's logo is also recommended and must be able to be viewed on PDFs without manipulation by NCDOT personnel.

For projects developed using the SS2/SS4 platform, all plan sheets shall have all the elements of the plan sheet border from the Design and Computation Manager contained within each file. They shall not be referenced. Design files delivered from or shared with other Units shall be referenced from the appropriate directories and the relative path saved to eliminate NCDOT personnel from having to recreate these connections.

#### 13.11.3.4 Profile Sheets

For projects developed using the SS2/SS4 platform, all profile sheets shall have the plan sheet border contained within each file and shall not be referenced to the files.

#### 13.11.3.5 Alignment Information

Alignment information for projects developed prior to implementation of ORD, submittal of a GPK file is required. Only the alignments used for the creation of the plans shall be in this file and shall contain the following information:

##### Corridor Modeling

- Existing ground profiles for each alignment

- Proposed profiles for each alignment
- Existing horizontal alignments
- Proposed horizontal alignments (w/ties to existing horizontal alignments on both ends)
- Ditch grades provided by Hydraulics
- Alignments used by corridor modeling

#### Open Roads Designer

- Existing ground profiles for each alignment
- Proposed profiles for each alignment
- Existing horizontal alignments
- Proposed horizontal alignments (w/ties to existing horizontal alignments on both ends)
- Alignments used by ALG file

All Alignments shall start at station 10+00.

Proposed horizontal and vertical alignment names shall match and follow the outline below.

Note: An exception is allowed for median divided roads that have one horizontal alignment with bifurcated grades for opposing lanes.

**Table 13-6 Standard Roadway Design Alignment Naming Convention**

<u>Chain Name</u>	<u>Profile Name</u>	<u>Comment</u>
<u>L</u>	<u>L</u>	
<u>L LT</u>	<u>L LT</u>	
<u>L RT</u>	<u>L RT</u>	
<u>NBL</u>	<u>NBL</u>	<u>North Bound Lane</u>
<u>SBL</u>	<u>SBL</u>	<u>South Bound Lane</u>
<u>EBL</u>	<u>EBL</u>	<u>East Bound Lane</u>
<u>WBL</u>	<u>WBL</u>	<u>West Bound Lane</u>
<u>Y#</u>	<u>Y#</u>	<u>Shall start with 1 and proceed along the project from beginning to end</u>
<u>RAB#</u>	<u>RAB#</u>	<u>Roundabouts</u>
<u>Y#LPA</u>	<u>Y#LPA</u>	<u>Loop [order, quadrant]</u>
<u>Y#RPA</u>	<u>Y#RPA</u>	<u>Ramp [order, quadrant]</u>
<u>SR#</u>	<u>SR#</u>	<u>Service Roads</u>
<u>WL#</u>	<u>WL# B</u>	<u>Wall may have both top and bottom profiles</u>
<u>CD#</u>	<u>CD#</u>	<u>Collector-Distributor</u>
<u>FLY#</u>	<u>FLY#</u>	<u>Flyovers, Y# may be added</u>
<u>LY_QC</u>	<u>LY_QC</u>	<u>At-grade Intersection [mainline, Y-line Q, quadrant]</u>
<u>DRW#</u>	<u>DRW#</u>	<u>Driveways</u>

### 13.11.3.6 Model Deliverables

#### Corridor Modeling

Any files containing graphics elements used to develop the model and the following:

\Roadway\CorridorModeling\:



- TIP# RDY\_CMD.dgn
- TIP#.ird
- TIP#.rdp
- TIP#.itl
- Shape input files for every alignment
- DTM and TIN file for every alignment
- Combined TIN file named TIP# RDY\_combined.tin
- Cross sections for every alignment
- Cross section lay out sheets for every alignment

\Roadway\CorridorModeling\Rddb\:

- cmjobRDY.alg
- cmjobRDY.xml
- planGraphics.txt

### **OpenRoads Designer**

Maintain Folder and File structure to preserve the ORD referencing and design constraints. Refer to Roadway Design Module 1 - File Management for guidance. Submit any files containing graphics elements used to develop the model and the following:

- TIP# RDY\_CMD.dgn
- TIP#.itl
  - Project WorkSet file (.dgnws)
- TIP# RDY\_SUP superelevation files for every alignment
  - Proposed Terrain Model merged with existing terrain
- Cross sections for every alignment
- All ORD TBB, PPL, PLD, PRD, PRS, XSD, XSS design, drawing and sheet models used to produce sheets for every alignment

#### **13.11.3.7 Cross Sections and Layout Sheets**

For projects developed using SS2/SS4, the cross section sheets (XPL) shall be created as one sheet per model instead of all in the default model using the cross section layout tool (NCDOT English XS.xssl).

If cross sections are too wide to fit on the appropriately scaled sheet, fold lines shall be utilized. Any deviation from this practice must be discussed with and agreed upon by the Roadway Design Lead.

#### **13.11.3.8 PDF Formatting for Submittals**

PDFs shall be created for all submittals requiring distribution beyond Roadway Design. Each set of PDFs shall meet the following criteria:



- Formatted to 22" x 34" in size; projects with cross sections over 30 sheets formatted to 11" x 17" and plot to the appropriate scale
- Text searchable (not scanned)
- Have a 0-degree rotation
- Have the ability to turn any and/or all levels on and off
- Conform to the naming convention below
- Combined PDFs should not exceed 50 MB

**Table 13-7 Sheet Breakdown for Submittal Types**

	<u>TTD</u>	<u>PLAN</u>	<u>PFL</u>	<u>XSC</u>
<u>DRPS</u>	<u>Combined</u>	<u>Combined</u>	<u>Combined</u>	<u>Combined</u>
<u>FI</u>				
<u>RPC</u>		<u>Individual Sheets</u>		
<u>FP</u>	<u>Individual Sheets</u>			

**Table 13-8 Submittal Phase and Sheet Name Acronyms**

<u>Submittal Phase Type</u>		<u>Sheet Names</u>	
<u>DRPS</u>	<u>Design Recommendation Plan Set</u>	<u>TTD</u>	<u>Title, Typical, Details</u>
<u>FI</u>	<u>Field Inspection</u>	<u>PLAN</u>	<u>All Plan Sheets</u>
<u>RPC</u>	<u>Right of Way Plans Complete</u>	<u>PFL</u>	<u>Profile Sheets</u>
<u>DCR</u>	<u>Design Complete Review</u>	<u>XSC</u>	<u>Cross Sections</u>
<u>FP</u>	<u>Final Plans</u>	<u>PSH</u>	<u>Individual Plan Sheets (PSH04, PSH05, ...)</u>

Naming Convention (see Electronically Sealed and Signed Plans Section for Final Plans)

- TIP# RDY Phase Sheet Name.PDF (ex. R2915B RDY RPC TTD.PDF)

**13.11.3.9 Electronically Sealed and Signed Plans Section for Final Plans**

Each plan sheet shall meet the following criteria:

- Saved as a separate PDF
- Text searchable (not scanned)
- Formatted to 22" x 34" in size; projects with cross sections over 30 sheets formatted to 11" x 17" and plot to the appropriate scale
- Have a 0-degree rotation

The file name shall follow the format: 100 001 B9999 RDY PSH01 (see breakdown details below). The first eight characters of the name will ensure proper placement.

**Table 13-9 Final Plans File Name Breakdown**

<u>100</u>	<u>All Roadway Plans will be in the 100 series of sheets</u>
<u>300</u>	<u>All Cross Section Sheets will be in the 300 series of sheets</u>

001	Sheet Number <u>Note: Gaps shall be provided between the numbers to allow for possible additions, (ex. 001, 003, 005, etc.)</u>
B9999	TIP number for the project
RDY	Roadway
PSH01	Plan sheet number

Download the plan file renaming tool from the *NCDOT CADD team site* to assist in sorting, sequencing, and formatting the numeric prefixes to the files.

Information developed for projects is subject to the Freedom of Information Act. As such, the roadway designer shall be prepared to provide any project related data when requested.

### **13.11.3.10 Electronic Signatures**

The Department has implemented procedures for Professional Engineers to digitally seal and sign plans. Submit all plans electronically in a PDF format with digital signatures. DocuSign was chosen by NCDOT to provide digital signatures, but providers can use any recognized eSignature tool to sign documents.

The North Carolina Board of Examiners for Engineers and Surveyors recognizes electronically generated seals as an acceptable form of the professional seal. Seal electronic plans in accordance with Title 21, Section .1100 Chapter 56 of the NCAC.

Refer to 21 NCAC 56 .1101, 21 NCAC 56 .1102 and 21 NCAC 56 .1103 for more specific information regarding NCAC rules.

- The seal may be a computer-generated seal or other facsimile that becomes a permanent addition to the plan sheet.
- The licensee's signature must be placed over, or near, the seal on the original document.
- The date of signing must be annotated on the original document.
- All sheets of engineering and surveying drawings must be sealed.
- A label stating 'Document not considered final unless all signatures completed' must appear near the North Carolina Professional Engineer seals on all sheets that are to be sealed.

In addition to the information provided above, the following plan sheets typically require the indicated seals:

1. Title Sheet – Roadway Design Engineer and Hydraulics Engineer.
2. Sheet 1A – Roadway Design Engineer.
3. Typical Sections – Roadway Design Engineer and Pavement Design Engineer.
4. Roadway Detail Sheets – Roadway Design Engineer and Hydraulics Engineer (if applicable)
5. Details from other Disciplines – Will be sealed by the Discipline Engineer.
6. Plan and Profile Sheets – Roadway Design Engineer and Hydraulics Engineer.

### 13.11.3.11 AASHTOWare Estimate

AASHTOWare Project (AWP) and the Pay Items and Quantities Tool (PIQ Tool) shall be used for entering pay items and quantities for all centrally let and Division let projects. The roadway designer is responsible for entering all roadway pay items and quantities while also ensuring all required supplemental information is correctly entered. The PIQ Tool is located on the Preconstruction project sites in SharePoint and was designed to provide roadway designers with an easy-to-use tool to enter contract line items and quantities. For projects developed by consultants, the PIQ Tool shall be utilized to enter final pay items and quantities. When projects are being developed by NCDOT staff, they should enter pay items and quantities directly through AWP. The latest AWP and PIQ Tool documentation and training materials can be found using the Preconstruction-Help link on the Preconstruction website.

# Chapter 14 Right of Way

## 14.1 Introduction

The acquisition of right of way to construct or widen a highway facility is an integral part of the project development process. This chapter provides guidance regarding the roles and responsibilities of the roadway designer for assisting in the development of the right of way plans including selecting appropriate right of way and easements; determining appropriate right of way monuments and access points; and incorporating fencing and gates.

Refer to the roadway right of way activities listed in the [NCDOT Project Delivery Network](#) (PDN) and coordinate with the Location and Surveys Unit and Right of Way Unit when establishing right of way and easement lines on every project.

The roadway designer's initial involvement in the right of way process may begin in either Stage 1 (Project Initiation) or Stage 2 (Alignment Defined) of the PDN. The roadway designer engaged by the Feasibility Studies Unit in Stage 1 is responsible for laying out the right of way limits and the Feasibility Studies Unit is responsible for requesting the right of way estimate. The roadway designer is also responsible for the following:

- Setting initial limits for right of way and temporary easements when completing the Design Recommendation Plan Set.
- Refining the right of way limits for the Field Inspection Plan Set by incorporating the completed drainage design, geotechnical recommendations, utilities, erosion and sediment control measures, signal poles, and other design features that affect the right of way.
- Coordinating with the Division and obtain critical information at the Field Inspection that will affect the right of way and easements shown in the plans.

In the Stage 3 (Plan-in-Hand), the other technical disciplines and units will continue to make minor adjustments to finalize their plans. Update the Right of Way and Easement Layout after receiving the final designs from all applicable disciplines and units.

Location and Design Approval (LADA) is a trigger document for obtaining Right of Way Authorization on some projects.

Refer to RDM Part II Chapter 12 Section 12.7 for additional information regarding the LADA process and project requirements.

Once Right of Way Authorization has been approved by the North Carolina Board of Transportation, the Location and Surveys Unit will be responsible for finalizing the Right of Way and Easement Layout as part of Stage 4 (Plans, Specifications, & Estimates) of the PDN. The Location and Surveys Unit is responsible for completing the final right of way series plan set after establishing all permanent right of way and easement monumentation by Professional Land Surveyors. The Location and Surveys Unit prepares the plan set in accordance with [North Carolina General Statute 136-19.4A](#) and the North Carolina Board of Examiners for Engineers and Land Surveyors policies. The Location and Surveys Unit is also responsible to ensure a portable document format (PDF) version of all final right of way series plan sheets with electronic signature by a Professional Land Surveyor in responsible charge be placed under the project Let Preparation 150 folder on the project's Connect NCDOT team site 15 weeks prior to let date. The Right of Way Unit is responsible for requesting North Carolina Board of

Transportation authorization to record the Final Right of Way Series Plan Set matching recorded right of way agreements and project established monumentation. The Location and Surveys Unit will record the Final Right of Way Series Plan Set within two weeks after the project is let to construction. Right of way revisions after project let require recording revised sheets and completing the Report of Final Right of Way and Permanent Easement Survey signed and sealed by a Professional Land Surveyor for replaced or re-established monuments.

For Division Purchase Order and Division Let projects, the Division Project Manager is responsible for submitting requests to the Right of Way Unit for right of way recordation.

Refer to the Right of Way Manual and other publications on the [NCDOT Right of Way Manuals and Publications](#) page of the Connect NCDOT website when establishing the right of way and easement lines for a project.

## 14.2 Selecting the Appropriate Right of Way

To select the appropriate right of way, become familiar with the functional classification of the roadway and the control of access definitions associated with each functional classification. The functional classification of the roadway affects which control of access designation to specify on a particular project. The Department has standardized definitions for the various types of right of way and control of access based on the function of the roadway, level of mobility and access, and whether the facility has traffic signals, driveways, or medians. Use the following definitions when planning and designing roadway projects:

- Full Control of Access – Connections to a facility provided only via ramps at interchanges. All cross streets are grade-separated. No private driveway connections are allowed. A control of access fence is placed along the entire length of the facility and at a minimum of 1,000 feet beyond the ramp intersections on the -Y- lines (minor facility) at interchanges (if possible).
- Limited Control of Access – Connections to a facility provided only via ramps at interchanges (major crossings) and at-grade intersections (minor crossings and service roads). No private driveway connections allowed. Place a control of access fence along the entire length of the facility, except at intersections, and at a minimum of 1,000 feet beyond the ramp intersections on the -Y- lines (minor facility) at interchanges (if possible).

Limited control of access typically serves to protect the mobility of motorized users on the corridor. Non-motorized facilities should be prohibited unless a careful evaluation has been completed which considers the needs and objectives for the corridor. The evaluation should include analysis of traffic operations, predictive crash modeling and tradeoffs for all modes of transportation to avoid potential safety issues and/or loss of mobility. If the determination is made to include non-motorized facilities, then they should be placed outside of the control of access fence.

- Partial Control of Access – Connections to a facility provided via ramps at interchanges, at-grade intersections, and private driveways. Private driveway connections are normally defined as a maximum of one connection per parcel. One connection is defined as one ingress and one egress point. The use of shared or consolidated connections is highly encouraged. Connections may be restricted or prohibited if alternate access is available through other adjacent public facilities. Place a control of access fence along the entire length of the facility, except at intersections and driveways, and at a minimum of 1,000 feet beyond the ramp terminals on the minor facility at interchanges (when practical).

Partial control of access typically serves to manage access along the corridor. Non-motorized facilities should not automatically be excluded from the facility. Instead, a careful evaluation should be completed which considers the needs and objectives for the corridor. The evaluation should include analysis of traffic operations, predictive crash modeling and tradeoffs for all modes of transportation to avoid potential safety issues and/or loss of mobility. If the determination is made to include non-motorized facilities, then their placement should be coordinated with the Roadway Design Unit, Integrated Mobility Division, and the Division.

- **No Control of Access** – Connections to a facility provided via ramps at interchanges, at-grade intersections, and private driveways. No physical restrictions, i.e., a control of access fence, exist. Normally, private driveway connections are defined as one connection per parcel. Consider additional connections if they are justified and if such connections do not negatively affect traffic operations and public safety.

Requests to add non-motorized accommodations to existing corridors should follow the encroachment guidelines set forth in the *NCDOT Utilities Accommodation Manual*.

The facility types and their typical associated control of access designations are as follows:

- Freeways and Interstates (Full Control of Access)
- Principal Arterials (Limited or Partial Control of Access)
- Minor Arterials and Collectors (Partial Control of Access or No Control of Access)
- Local (No Control of Access)

Maintain control of access at roundabouts and directional crossovers with median U-turns.

Refer to RDM Part I Chapter 8 for additional guidance on roundabouts and directional crossovers.

### 14.2.1 Guide for Establishing Proposed Right of Way and Easements

Establish and show the proposed right of way and easements on the plans before finalizing the Right of Way Plan Set. Set the right of way at the minimum distance required to construct and maintain the project. Select the appropriate right of way based on the design and discuss the right of way placement with the Division at the Field Inspection. Use the following guides:

1. Interstate, Freeway and Expressway projects generally have fully controlled access. In PDN Stage 1 (Project Initiation), the right of way contains the cross section and allows for 25 feet beyond the construction limits. A distance of between 10 feet outside the construction limits should be sufficient when establishing the right of way in the later stages of project development.  
  
The right of way width for a four-lane section for this type of roadway typically ranges from 250 feet to 300 feet for rural projects and 150 feet to 200 feet for urban projects. It is no longer required to maintain a consistent right of way width.
2. Principal Arterial projects generally have limited or partial control of access. In general, right of way will be wide enough to include all cross-sectional elements throughout the project whether a uniform or variable right of way width is used. Establish from 5 feet to 15 feet beyond the construction limits.
3. Rural Arterial and Collector projects can be partial control of access or no control of access. In general, right of way will be wide enough to include all cross-sectional

elements throughout the project whether a uniform or variable right of way width is used. Establish right of way from 5 feet to 15 feet beyond the construction limits.

A right of way width for a two-lane arterial or collector typically ranges from 100 feet to 150 feet. For a four-lane section of roadway, a width of 150 feet to 250 feet is adequate.

4. Urban Arterial projects may contain the cross section within the proposed right of way or use a combination of right of way and easements. Establish right of way from 5 feet to 15 feet beyond the construction limits.

As a rule of thumb, the right of way width for an urban arterial typically ranges between 100 feet to 150 feet with or without curb and gutter.

5. Local projects generally have the total cross section contained within the proposed right of way. Set right of way or easements 5 feet to 10 feet outside the construction limits. A typical width of 60 feet to 100 feet is generally adequate.
6. Curb and Gutter facilities generally have the right of way set to contain the berm plus a buffer area. Place the right of way a minimum of 15 feet from the face of the curb and at least 5 feet beyond the hinge or shoulder point of the berm, when practical.
7. In all situations:
  - a. Numerous factors can affect the placement of the right of way. Take constructability and maintenance into account when establishing the proposed right of way. Discuss the right of way placement with the Division at the Field Inspection.
  - b. Establish right of way at intersections to allow for sufficient sight distances (sight triangles) for all street returns and railroads. This distance is defined as a triangle, as each leg of the intersection requires sufficient sight distance to adjacent approaches.
  - c. Consider vehicle recovery area based on the amount of traffic and the design speed of the facility when establishing the proposed right of way.
  - d. Avoid impacts that could result in total acquisitions or high damage costs. Examples include, but are not limited to, the followings:
    - i. Retention ponds and basins
    - ii. Driveway access changes (number, width, grades)
    - iii. Septic tanks or septic drain fields
    - iv. Wells
    - v. Parking lots, parking areas, and parking spaces
  - e. Follow all commitments in the environmental document.
  - f. Review the right of way with Division personnel including the Division Construction Engineer, Division Right of Way staff, and the Division Locating Engineer prior to acquisition.
  - g. Set the proposed right of way at a dimension that includes the project footprint and encompasses the clear zone as defined by the latest RDG. Use clear roadside recovery area to establish minimum width of right of way.
  - h. For curb and gutter sections:



- i. Set the proposed right of way at a dimension that encompasses the berm and protects the clear zone.
  - i. Include things such as slope stakes as well as lateral ditches, berm ditches, erosion control devices, culvert wing walls, end walls, and retaining walls within the construction limits.
  - j. Where practical, place right of way beyond the cut and fill slopes to allow for adequate maintenance of the slopes.
  - k. Set right of way a minimum of 5 feet outside the ditch bottom.
8. Other considerations:
  - a. Analyze the placement of noise and retaining walls in close proximity to existing buildings and permanent structures. Determine if the existing right of way is sufficient or if additional right of way or easements are required for the construction and maintenance of the wall. As a general rule, establish the right of way a minimum of 10 feet from any fill wall. For cut walls, coordinate with the geotechnical engineer to determine right of way and easement requirements for soil nail and anchored retaining walls. Drainage and other design features may also affect the placement of the right of way. Discuss the placement of right of way adjacent to any noise or retaining wall with the Division at the Field Inspection.
  - b. Keep travel lane proximity to existing buildings and other structures in mind. Maintain appropriate clear zone and horizontal offsets or provide appropriate positive protection with additional buffer area where possible.
  - c. The establishment of uniform right of way throughout the project limits is no longer standard practice. In special situations; however, it may be more economical or preferred by the Division to establish a uniform right of way width. In this case, use easements to provide a sufficient working area for construction.

### 14.3 Right of Way Monuments on Plans

Right of way monuments are installed to identify the highway right of way boundary line. Review proposed locations of the monuments at the Field Inspection and adjust as recommended and approved by the Division Right of Way Agent and the Division Location and Surveys Team Lead. To fit field conditions, these locations may be further adjusted in the Final Right of Way and Easement layout by the Division Right of Way Agent and Division Location and Surveys Team Lead as part of Stage 4 (PS&E).

Do not show right of way monuments, including permanent easement monuments on the roadway plans until the development of the Field Inspection Plan Set at PDN Stage 2 (Alignment Defined).

Place monuments at the following locations:

1. Where there is any change in direction of the right of way line.
2. At a maximum spacing of 1,500 feet. Terrain characteristic and construction limits may dictate modification.
3. At points on the right of way boundary line where control of access begins and terminates. (Does not apply to partial control of access.)
4. At the beginning and end of the project.



5. Where the right of way is unusual or where clarification of the right of way is necessary.
6. On projects with uniform right of way, show monuments at the following locations:
  - a. At the point of curvature (PC) and point of tangency (PT) of simple curves and point of compound curvature (PCC) of compound curves.
  - b. At tangent to spiral (TS), spiral to curve (SC), curve to spiral (CS), and spiral to tangent (ST) of simple spirals.
  - c. At the CS and SC of compound spirals.
  - d. Use tangent right of way lines between the TS and SC, CS and ST, and the CS to SC and label as “Chord” on the plans.
7. Do not show right of way monuments on property lines or property corners unless they can be established and confirmed by the Division Locating Engineer. These monuments may be added only in special cases, as requested and approved by the right of way agent in charge, during the review of right of way plans with the Division Locating Engineer.
8. The Division Engineer (or representative) will specify the type of monuments to be used at the Field Inspection, so that a pay item and general note can be included in the contract when needed.
9. Right of way monument locations are to be labeled by stations or partial stations, offset distance from centerline to two decimal places (hundredth), alignment name, and LT or RT of centerline. Refer to RDM Part II Chapter 12 Section 12.1.
10. Place monuments on the right of way lines at the proper locations.
11. Concrete or granite monuments should be placed outside of the Clear Zone.

### 14.3.1 Existing Right of Way

The existing right of way and monuments are found in the Final Surveys file provided by the Locations and Surveys Unit. Use the symbology shown in Figure 14-1 to represent the existing right of way monuments and right of way lines.

Figure 14-1 Existing Right of Way Line and Monuments

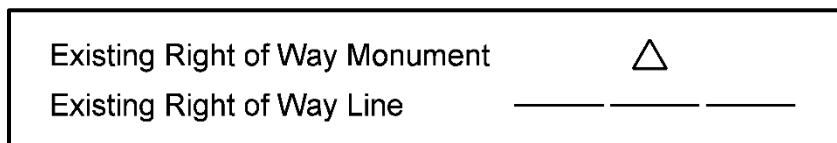

### 14.3.2 Proposed Right of Way

The roadway designer is responsible for establishing the new or proposed right of way during the development of the right of way and easement layout. Use the symbology shown in Figure 14-2 to represent proposed right of way monuments and right of way lines.

- Show proposed right of way monuments in the plans and stake for both the proposed right of way and concurrent proposed right of way/control of access. This includes where it begins, ends, and changes direction, as well as at control points or intermediate points on long tangents.

Figure 14-2 Proposed Right of Way Line and Monuments

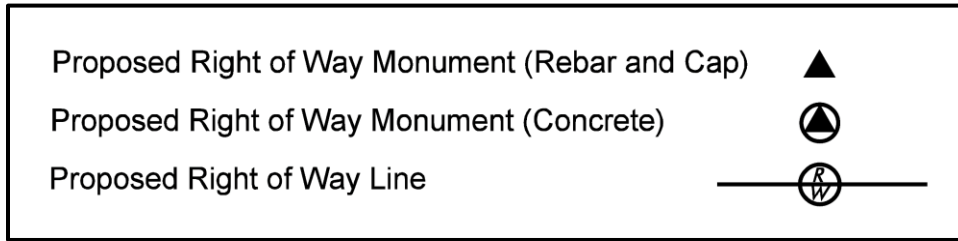

### 14.3.3 Control of Access

All fully controlled, limited controlled, and partially controlled facilities will require control of access in addition to right of way. Monument the control of access using rebar and cap or concrete or granite right of way monuments as deemed appropriate by the Division Engineer (or representative) (See new right of way monumentation above). Use the Proposed ROW and CA Line when the right of way and control of access right of way are the same. Use the symbology shown in Figure 14-3 to represent the existing and proposed right of way with control of access fencing.

- Show the proposed control of access monuments in the plans and stake where the proposed control of access does not run concurrent to the proposed right of way.

The Location and Surveys Unit will initially stake control of access monuments as rebar and cap. The Division will determine if the contractor resets them as concrete monuments which will require the Right of Way Markers and/or Control of Access Markers pay items.

Figure 14-3 Control of Access

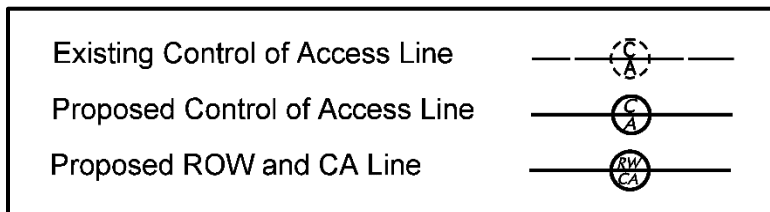

Use concrete control of access monuments or control of access monuments with rebar and cap when there is no control of access fence due to either short sections of control of access right of way (less than 100 feet) or natural restriction such as a wall. Use control of access monuments on full control of access projects where the control of access is not concurrent with the right of way. Use the symbology shown in Figure 14-4 to represent the control of access right of way with control of access monuments.

Figure 14-4 Control of Access with C/A Monument

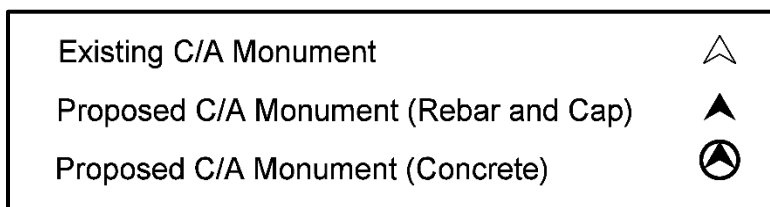

## 14.4 Access Points on Partial Control of Access

Show access points on partial control of access projects on the project plans by station locations and offset distance. Do not show a dimension for the opening width.

In establishing the stations, a width of 60 feet is typically used but it can vary. Label the opening as “Access Point” on the roadway plans.

Label the Access Points on the Design Recommendation Plan Set without station and offsets. Discuss the location of these openings with the Division during preparation of the Field Inspection Plan Set. Refer to the Partial Control of Access definition in Section 14.2 above. While more than one access point can be granted per parcel, it should be the exception, not the rule. Determine the final position and number of openings during negotiation by the Right of Way Unit.

## 14.5 Easements

Classify easements as either temporary or permanent depending on their purpose and discuss with Division personnel and the Division Right of Way Agent at the Field Inspection. Involve the Utilities Unit and utility owners as early as possible to establish permanent utility easements and minimize plan changes.

1. Temporary Construction Easements (E) are used to provide the contractor sufficient working area to construct things such as slopes, ditches, and silt control areas where continuous maintenance will not be required. Describe break points using a station and distance as described for the right of way.
2. Temporary Drainage Easements (TDE) are used to provide the contractor sufficient working area to clean out existing ditches and channels, construct new ditches and channels, construct large silt basins, and to install other drainage facilities where maintenance will not be required. Define TDE using a combination of station and distance.
3. Permanent Drainage Easements (PDE) are used at any location where the Department has a need, or is obligated, to maintain a drainage facility. Define PDE using a combination of station and distance.
4. Permanent Drainage / Utility Easements (DUE) are used to construct and maintain drainage and utility facilities through and across a property. Define DUE using a combination of station and distance.
5. Permanent Utility Easements (PUE) are used to construct and maintain a utility facility through and across a property. PUE can include both aerial and underground utilities. Define PUE using a combination of station and distance.
6. PUEs are provided by the Utilities Unit. Utility easement needs (PUE and TUE) are determined by the utilities and the Utilities Designer, aggregated by the Utilities Coordinator, and approved by the Utilities Lead. After obtaining approval, the Utilities Coordinator will provide the approved easement needs to the Roadway Design Lead specified as corners or specified as widths with angles for protruding areas. No changes can be made to the easements without approval of the Utilities Coordinator, Utilities Lead, and Project Manager. Do not establish parallel alignments that would leave any separation between the highway right of way line and the PUE or TUE. In other words, do not allow gaps between the right of way line and easement.

7. Temporary Utility Easements (TUE) are used to provide the contractor sufficient working area to construct utility facilities where maintenance will not be required. Define TUE using station and distance. TUEs are provided by the Utilities Unit.
8. Aerial Utility Easements (AUE) are used to construct and maintain an aerial utility facility through and across a property. AUEs only cover aerial utilities and necessary appurtenances. Define AUE using a combination of station and distance. See guidelines for placing PUE above. AUEs are provided by the Utilities Unit.

TDEs are provided by the hydraulics engineer. Make a distinction between the use of temporary construction easement and temporary drainage easement based on their expiration time. A temporary drainage easement reverts to the property owner as soon as the task is complete, while a temporary construction easement does not expire until completion of the contract.

In some cases, areas beyond larger drainage pipes and structures are needed for stream or channel maintenance. On rural projects, this area should normally be purchased as regular right of way in lieu of permanent easements, if the area does not extend beyond 75 feet from the parallel right of way line. If the area extends beyond 75 feet, consult the Right of Way Agent to determine whether to use permanent drainage easement or right of way.

It may not be feasible to place poles outside the clear zone. Urban development, terrain, environmental impacts, historical property, structural conflicts, and cost for right of way or relocation cost may affect the feasibility of relocating utilities outside the determined clear zone. The final decision to leave or relocate overhead utilities within the clear zone will be the responsibility of the project team. The decision to bury existing overhead utilities within the clear zone will be a joint discussion among the Utilities Unit, Division Engineer, roadway designer, and cost review committee.

Use the symbology shown in Figure 14-5 to represent the various types of easements.



**Figure 14-5 Temporary and Permanent Easement Lines**

Existing Easement Line	— — — E — — —
Proposed Temporary Construction Easement	———— E —————
Proposed Temporary Drainage Easement	———— TDE —————
Proposed Permanent Drainage Easement	———— PDE —————
Proposed Permanent Drainage/Utility Easement	———— DUE —————
Proposed Permanent Utility Easement	———— PUE —————
Proposed Temporary Utility Easement	———— TUE —————
Proposed Aerial Utility Easement	———— AUE —————

### 14.5.1 Permanent Easement

All permanent easements require monuments to flag and record the limits of the permanent easement. Rebar and cap monuments are commonly used to flag PDE and PUE but may also be needed to flag easements for right of way when right of way cannot be acquired when crossing rivers and lakes that are owned by a private entity. Use the symbology shown in Figure 14-6 to represent the permanent easement.

Figure 14-6 Permanent Easement Monuments

Existing Permanent Easement Monument	
Proposed Permanent Easement Monument (Rebar and Cap)	

## 14.6 Guidelines for Control of Access Fencing

Control of access fence is erected to restrict access to the highway facility by vehicles, pedestrians, and wildlife. Establish fencing on all full control of access projects along the right of way or between the freeway and frontage road to prohibit access to the control of access facility. Place control of access fence along the entire length of the facility and for the length of control of access being acquired beyond the ramp intersections along the -Y- lines (minor facility) at interchanges. Refer to Section 9.3.7 to determine the length of control of access needed at interchanges. Fence partial control of access projects unless the Division requests control of access monuments in lieu of fencing. Control of access fence will be constructed and maintained by NCDOT. Landowners will not be allowed to install fence within the control of access right of way. Study each project individually to determine if the fence can be eliminated at rivers, streams, deep cuts, or high fills. Discuss questionable areas at the Field Inspection and include recommendations in the Field Inspection Report from the Division Construction Engineer. Install fencing in accordance with the latest [NCDOT Roadway Standard Drawings](#) Std. Nos. 866.01, 866.02, 866.03, and 866.04.

Install fencing on control of access facilities in accordance with the following guidelines:

- Ensure fencing of full control of access facilities is as complete as practical. Avoid gaps in the fence.
- Include fencing items as part of the grading contract (when applicable).
- Install fencing where it is needed to retain livestock when the existing enclosures are disturbed. See Section 14.8 below.
- Use either woven wire or chain link fencing. Chain link is recommended for urban areas, rest areas, and school areas.
- Fence all interchanges to the control of access limits.

Use one of two methods at locations that require fence to close off the mainline at -Y- lines. The most desirable method is to tie the fence to the bridge. The next acceptable option is to tie the fence to the guardrail. When tying fence to guardrail, locate tie points a minimum of 12 feet 6 inches beyond the guardrail end unit. Refer to Figure 14-7 and Figure 14-8 for an illustration of the two methods.

Review fence locations closely at the Field Inspection. The Right of Way Unit will identify locations requiring disturbance of existing fence enclosures. These areas shall be covered by the project special provisions.

Figure 14-7 Guide for Fence Locations at -Y- Line over Freeway

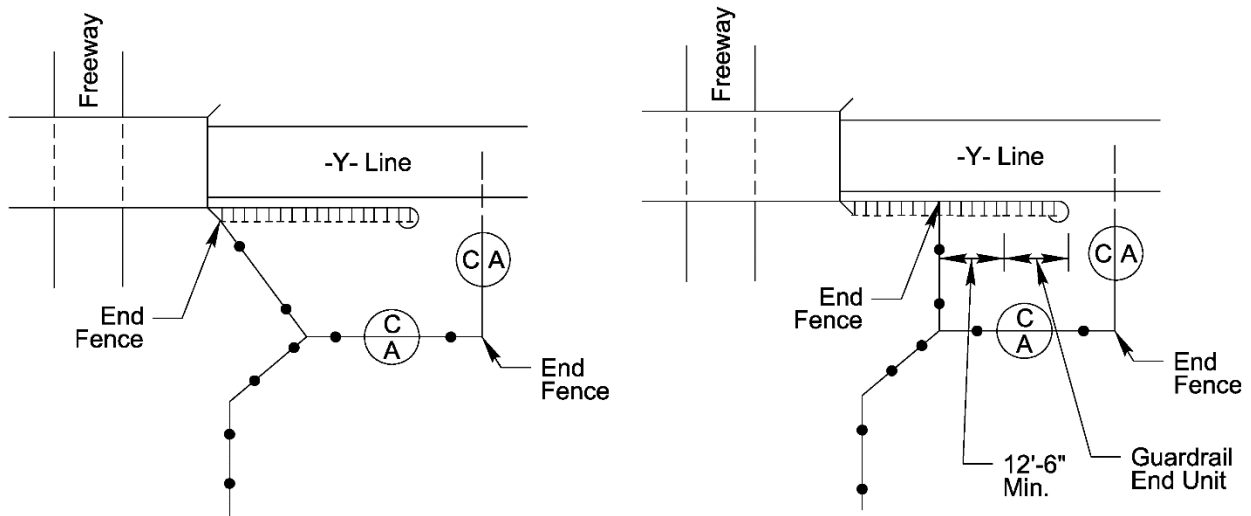
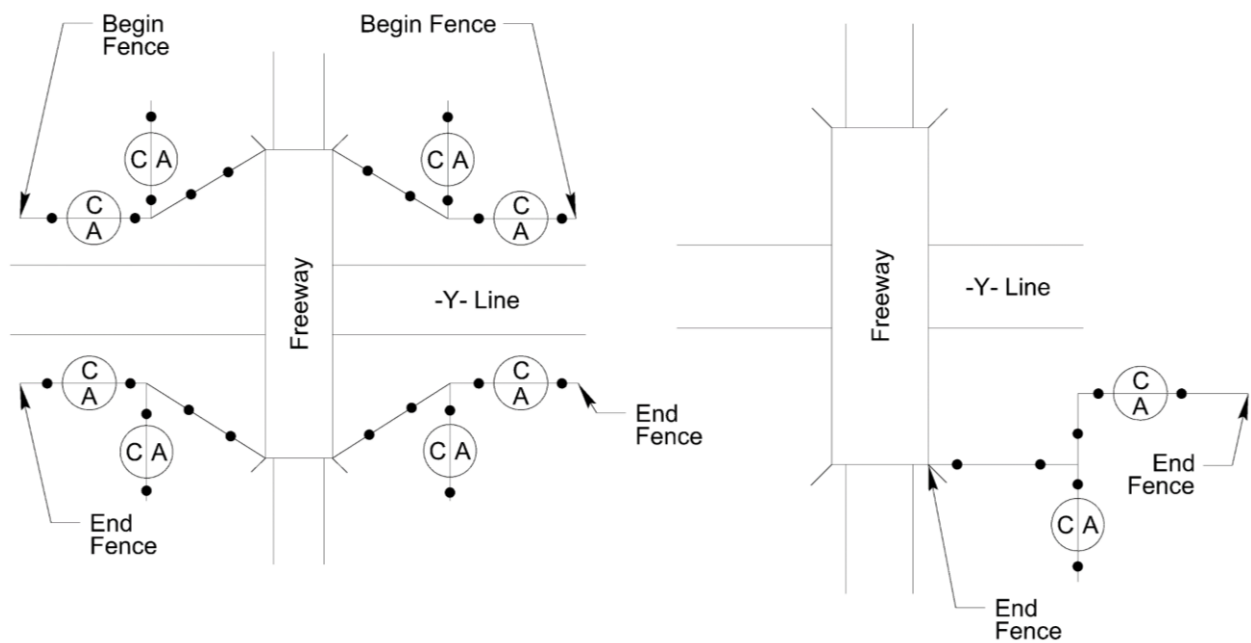

Figure 14-8 Guide for Fence Locations at Freeway over -Y- Line



### 14.6.1 Types of Fences

Use either woven wire or chain link fence for establishing control of access. Unusual conditions may justify the use of a special type of fence, such as security fence or barbed wire fence, which must be approved by the Division Engineer (or representative). Discuss the type of fence to be used as early possible and resolve any differences of opinion prior to the distribution of the Right of Way Plan Set in PDN Stage 3 (Plan-In-Hand). It is recommended that the roadway designer discuss the type of fence with the Division during development of the Design Recommendation Plan Set. The Filed Inspection provides another opportunity for the project team to recommend changes to the fence type.

1. Woven Wire Fence – Use woven wire fence except where there is a specific need for chain link fence or a special type of fence. When chain link or a special type of fence is being considered, the land usage at the time the project is in the design stage should be the determining factor unless a change in land use is imminent. Do not base this decision on blanket categories such as anticipated development or zoning classifications. Woven wire fence will typically be erected in rural areas.

The standard height of woven wire fence is 47 inches.

2. Chain Link Fence – Use chain link fence in the following areas:
  - a. A residential area where the average size of a lot adjacent to the right of way does not exceed 1 acre.
  - b. Any area where medium to heavy pedestrian activity will routinely occur closer than 150 feet from the proposed fence location. Study developed land to determine if this type of activity is generated. Do not use chain link fence in institutional, commercial, office, or industrial areas that do not generate such activity. The presence of buffer zones or park like areas adjacent to a developed area will often preclude the need for chain link fence.
  - c. Any area which the right of way agreement with the property owner requires that chain link fence be installed by NCDOT.
  - d. An area where short sections of woven wire fence would be required to comply with the policy.

The standard height of chain link fence is 48 inches.

3. Specialty Type Fence – Consider specialty type fence on a case-by-case basis and discuss during the Field Inspection. The need for specialty fencing may also be identified during right of way negotiations. Special fences include security fencing, barbed wire fencing, masonry walls, and different types for fencing used for screening, landscape purposes, or sound barriers.

Property owners may request specialty fencing and pay for the fence as a betterment outside of the right of way negotiations. Coordinate with the Division Construction Engineer and Division Right of Way Unit to address specialty fencing to be constructed as part of the project.

Note that any specialty fencing specified in the final construction plans may require a special detail and special provision.

### 14.6.2 Fencing of Rest Areas and Welcome Centers

Determine the type of fence to be used at rest areas or welcome centers on an individual basis through coordination with the Roadside Environmental Unit and Division.

### 14.6.3 Fencing of Truck Weigh Stations

Determine the type of fence to be used at truck weigh stations on an individual basis through coordination with the Division.



#### 14.6.4 Fencing in Proximity to Airports

Fencing in proximity to airports shall be discussed with the Federal Aviation Administration to determine if nonmetallic fencing should be used. Consult the Division of Aviation when projects are located within 10 miles of an airport.

#### 14.6.5 Fence Locations at Rivers and Streams

Detail the proposed method of fencing at streams in the plans and discuss at the Field Inspection. Tie the fence into the wingwalls at box culverts.

#### 14.6.6 Fence Locations at 54 Inches Pipes and Above

Tie fence to the reinforced endwalls of pipes 54 inches and larger.

#### 14.6.7 Fence Locations at Overpasses

Erect fencing at overpasses in accordance with one of the suggested treatments shown in Figure 14-7 and Figure 14-8. In locations where the fence is tied into the bridge, take extreme caution to assure that sight distances are not obstructed.

### 14.7 Fencing outside of the Control of Access

Fencing may be needed on roadway facilities outside of the control of access. Replace existing fence affected by construction in kind. Include replacement of existing fence either in the contract and shown on the roadway plans or addressed as part of the right of way negotiations. Discuss fencing at the Field Inspection to identify all fencing that will need to be included in the roadway plans. All types of fences identified in Section 14.6.1 above can also be used outside of the control of access right of way. Include specialty fencing in the right of way negotiations whenever possible.

### 14.8 Early Fencing (Pre-fencing)

Early fencing, also referred to as pre-fencing, may be needed to ensure that fencing for livestock or other special conditions is maintained during construction. The Right of Way Unit is responsible for identifying the need for early fencing and submitting a letter to the Project Manager. Discuss the need for early fencing at the Field Inspection.

### 14.9 Gates

When it is necessary to gain access to utilities, drainage areas, and other areas within the fencing or fence line, consider a locked gate. Determine the use of gates on a project-by-project basis and discuss the need for gates at the Field Inspection. Show approved gates clearly on the final construction plans.

The standard types of gates are either single or double gates. Clearly denote the gate height, gate width, and opening dimensions on the plans.

Refer to [NCDOT Standard Specifications for Roads and Structures](#) Section 866 and [NCDOT Roadway Standard Drawings](#) Std. Nos. 866.01, 866.02, and 866.03 for additional guidance.



## 14.10 Additional Acquisitions

Acquisitions are handled through the Right of Way Branch. For claims needing additional acquisitions after the original claim has been settled, refer to the [NCDOT Right Of Way Manual](#) section 4.17 for more information on the parcel designation process.

This page intentionally left blank.

# Chapter 15 Estimates and Computations

## 15.1 Introduction

In addition to preparing clear and concise roadway plans, the designer will compile an accurate engineer's estimate. Engineer's estimates are central to establishing the basis for key project decisions at the various stages of project development. Construction cost estimating is defined as the projected or forecasted construction cost of a program, project, or operation. Cost estimation is the process by which, based on information available at a specific phase of project development, the ultimate cost of the project can be estimated. Engineer's estimates are an important part of the design process and help management place projects in the fiscal year they anticipate funding availability. The roadway designer is responsible for developing quantities for construction cost estimates that include, but are not limited to, a Conceptual Construction Estimate, Initial Design Estimate, Plan-in-Hand Estimate, and Final Construction Quantities for Roadway Plans.

It is critical that the roadway designer identify all applicable pay items, also referred to as contract bid items, associated with the project and accurately compute the quantities of those pay items. Failing to properly quantify the pay items can lead to costly field changes. This chapter will provide guidance on estimate submittals at various stages of project development, identifying applicable roadway pay items, computing pay item quantities, and preparing engineering estimates.

## 15.2 Estimate Submittals

NCDOT has four primary estimates that are submitted during project development. Estimates should be updated when there are significant changes to the project scope or at the request of the NCDOT Project Manager.

Refer to the [NCDOT Project Delivery Network](#) (PDN) for detailed guidance on the activities and other deliverables associated with the preparation of the construction estimates.

A brief description of the four primary estimate submittals is provided in this section. Detailed estimating and computation guidance are provided in Sections 15.3 through 15.6 below. References to other resources and guidelines are provided to aid in preparing construction cost estimates at any stage of project development.

Prepare the Conceptual Construction Estimate, Initial Design Estimate, and Plan-in-Hand Estimate on the standard NCDOT Microsoft Excel Construction Estimate Form which can be found in Section II of the [NCDOT Conceptual Construction Estimation Guidelines](#). Submit the Final Construction Quantities for Roadway Design Plans using either the NCDOT Pay Items and Quantities Tool (PIQ Tool) or AASHTOWare Project (AWP).

Refer to Section 15.6 below for additional guidance on the PIQ Tool and AWP. Use the [Construction Cost Estimate Forms](#) for submittals after Stage 1 Project Initiation.

### 15.2.1 Project Initiation (Stage 1)

At the Project Initiation Stage (PDN Stage 1), the roadway designer is responsible for submitting the Conceptual Construction Estimate quantities to the [NCDOT Feasibility Studies Unit](#) or the NCDOT Project Manager as a part of developing the express design. Include quantities for all alternatives/alternates under consideration.

Update the Conceptual Construction Estimate quantities if needed, after the completion of the express design prior to project scoping. The NCDOT Project Manager is responsible for requesting pricing of the quantities from the Preliminary Estimates Group of NCDOT Estimating Management in the Contract Standards and Development Unit.

Refer to [NCDOT Conceptual Construction Cost Estimation Guidelines](#) for additional information regarding the preparation of the Conceptual Construction Estimate.

### 15.2.2 Alignment Defined (Stage 2)

The roadway designer may be required to provide updated construction estimate quantities during the PDN Stage 2 (Alignment Defined). Updated construction estimate quantities may be needed during the development of the Environmental Document and the Field Inspection Plans. The NCDOT Project Manager will specify when construction estimate quantities will be required for Stage 2 at project scoping.

The PDN activity associated with the preparation of the Initial Design Estimate is 2RD2 Prepare for Field Inspection. One of the major deliverables associated with this activity is the development of quantities for the construction estimate. The roadway designer, in coordination with other disciplines or units, is responsible for developing pay item quantities associated with the development of the Design Recommendation Plan Set. This estimate is similar to the Conceptual Construction Estimate but is updated to reflect changes in the design and may contain additional pay items. The roadway designer may also begin developing pay items in accordance with [NCDOT Standard Specifications for Roads and Structures](#) and [NCDOT Master Pay Item List](#) by the level of design.

Submit the Initial Design Estimate quantities to the NCDOT Project Manager. The NCDOT Project Manager is responsible for requesting an updated construction cost estimate from the Preliminary Estimates Group of [NCDOT Estimating Management](#) in the Contract Standards and Development Unit.

### 15.2.3 Plan-in-Hand (Stage 3)

The roadway designer, in coordination with other disciplines or units, is responsible for developing the construction cost estimate quantities for the Plan-in-Hand Estimate in PDN activity 3RD1 Complete Roadway Design. Update the pay item quantities associated with the proposed design to reflect any design revisions or updated recommendations from other technical units or the Division. The NCDOT Project Manager will specify when updates to the construction estimate quantities will be required for Stage 3 at project scoping.

The Plan-in-Hand Estimate is based on the Initial Design Estimate and may be more detailed due to the plans being in the final stage of design. Update all pay items, quantities, and units in accordance with [NCDOT Standard Specifications for Roads and Structures](#) and [NCDOT Master Pay Item List](#).

Prepare calculation of quantity sheets for all pay items not found in a summary in the roadway plans.

Submit the Plan-in-Hand Estimate quantities to the NCDOT Project Manager. The NCDOT Project Manager is responsible for requesting an updated construction cost estimate from the Preliminary Estimates Group of [NCDOT Estimating Management](#) in the Contract Standards and Development Unit.

### 15.2.4 Plans, Specifications, & Estimates (Stage 4)

Updates to the construction cost estimate quantities may be requested at any point in PDN Stage 4 (PS&E). The NCDOT Project Manager will specify when updates to the construction estimate quantities will be required at project scoping.

In PDN activity 4RD1 Finalize Contract Package, the roadway designer is responsible for entering all final roadway construction quantities into either AWP or the PIQ Tool. AWP can only be accessed by NCDOT personnel.

Refer to Section 15.6 below for additional guidance on how to use AWP and the PIQ Tool.

Update all pay items, quantities, and units in accordance with the latest [NCDOT Standard Specifications for Roads and Structures](#) and [NCDOT Master Pay Item List](#). Calculation of Quantities Sheets are required for all pay items not shown in a roadway summary.

Refer to Section 15.4 below for additional guidance regarding calculations and Calculation of Quantities Sheets.

## 15.3 Determination of Pay Items

To prevent costly project overruns, it is imperative the designer prepare an accurate and complete engineer's estimate for the project. To accomplish this, the roadway designer must identify all applicable contract pay items associated with the project.

Pay items (also sometimes referred to as contract bid items) reflect the work being performed on a project. All work done on a project must be covered by a pay item or be incidental to a pay item. Asphalt or Portland cement concrete pay items indicate the type of pavement specified in the plans. The Borrow Excavation and Unclassified Excavation pay items indicate the materials needed to construct the embankment or to be excavated within the project limits.

Identifying all pay items can be difficult and requires familiarity with the plans. Pay items can be gleaned from various sources within the roadway plans. The Type of Work on the title sheet provides information on various roadway pay items. The information listed in the pavement schedule and typical sections is also an excellent source for numerous roadway pay items. Other sources include special details, summary of quantities, roadway plan sheets, and cross sections.

The first step in preparing the engineer's estimate involves compiling a list of pay items that are based on the most current roadway plans. Familiarity with the [NCDOT Standard Specifications for Roads and Structures](#) and [NCDOT Master Pay Item List](#) will assist the roadway designer in determining which contract bid items to include in the estimate.

### 15.3.1 Standard Specifications for Roads and Structures

The NCDOT Standard Specifications for Roads and Structures are part of the construction contract. These specifications detail the work, materials, equipment requirements, construction methods, testing, and method of payment for bid items in the contract. The standard specifications can be considered a field guide on what materials to use, how to install them, the desired level of quality, and how to pay for them.

Refer to [NCDOT Standard Specifications for Roads and Structures](#) when estimating quantities or preparing a Calculation of Quantities Sheet for a particular pay item.

The most common pay items can be found in the standard specifications. If a pay item is not listed in the standard specifications, a project special provision (PSP) is required. Please note

the standard specifications are updated periodically, and the designer should take care in using the correct edition when preparing the estimate.

### 15.3.2 Standard Provisions

Standard Provisions (SPs) are statewide provisions that encompass the General and Roadway sections of the project's proposal. The SPs are maintained by the State Proposals and Specifications Engineer in the Contract Standards and Development Unit. The [State Proposals and Specifications Engineer](#) is responsible for creating the project proposal for centrally let projects and the Division Proposals Engineer is responsible for creating the project proposals for Division let projects.

### 15.3.3 Project Special Provisions

Any pay item not found in the [NCDOT Standard Specifications for Roads and Structures](#) requires a Project Special Provision (PSP). The PSP is generated and maintained by the units and Divisions within the Department and will be included with the Final Contract Package. Follow the [NCDOT Provisions Writers' Guide](#) when developing PSPs.

The development of PSPs is not a common responsibility of the roadway engineer, but projects may include unique roadway pay items that will require PSPs. The roadway designer is still responsible for identifying when a PSP is needed for a roadway pay item. Once identified, coordinate with the [State Proposals and Specifications Engineer](#) to develop these provisions. The PSPs are more common to the Roadway Lighting and Electrical Plan submittal.

Refer to RDM Part II Chapter 16 for additional information regarding the lighting and electrical design process.

### 15.3.4 Master Pay Item List

Review the most current NCDOT Master Pay Item List to ensure all pay items are included in the estimate. The list contains all standard and SP pay items used by the units and disciplines within the Department. The current list is available in the Additional Resources section on the [Contracts Resources](#) page of the Connect NCDOT website. Item Numbers 0000100000-N (Mobilization) through 3659000000-N (Preformed Scour Holes with Level Spreader Apron) are typically entered by the roadway designer and Item Numbers 5000000000-E through 5273000000-E are typically entered by the roadway lighting engineer.

Table 15-1 lists the common information referenced in the [NCDOT Master Pay Item List](#).

**Table 15-1 Master Pay Items List Information**

Column Heading	Examples	
Type	D	Drainage
	F	Fence
	FE	Ferry
	G	Grading
	GR	Guardrail
	M	Miscellaneous
	P	Paving
	Y	Temporary Guardrail

Column Heading	Examples	
Item Number	0036000000-E	Master Pay Item number
Section #	225	<i>Standard Specifications for Roads and Structures</i> section number
	SP	Special Provision
Units	LS	Lump Sum
	EA	Each
	LF	Linear Foot
	SY	Square Yard
Description	Mobilization	Pay Item name

The NCDOT Master Pay Item List contains pay items from the NCDOT Standard Specifications for Roads and Structures, SPs, and PSPs. Pay items that require SPs and PSPs are denoted as SP in the Section column.

Use one of the generic pay items when entering PSP pay items. The generic SP pay items cover different disciplines and categories such as Generic Miscellaneous Item and Generic Grading Item. Select the discipline or category that best fits the work being performed in the PSP. There are also non-generic SP pay items that can be selected from the list. Include the description of the item on the construction estimate form when using any generic pay item. Consult the State Proposals and Specifications Engineer if you have any questions regarding which generic item to use.

### 15.3.5 Proprietary Products

To encourage competition in the project letting process, [General Statute 133-3](#) has been developed to mandate and encourage free and open competition on all public contracts while not restricting the use of new and innovative products. Refer to the [NCDOT Proprietary Product Guidelines](#) found on the [Products page of the Connect NCDOT website](#) for detailed guidance on the state and federal requirements when specifying proprietary items into a contract. These procedures state the engineer has an inherent duty to use generic products instead of simply specifying proprietary products in contract documents. Proprietary products can be defined as a manufactured component or product sold under a brand name owned by an individual or company, rather than a generic name. Proprietary products are typically protected by patents or trademarks. Approval is required prior to letting when specifying a proprietary product in the contract, to do this follow the [NCDOT Proprietary Product Guidelines](#).

Conflicts with the use of proprietary items will often arise when developing SPs and PSPs. Take care in writing restrictive specifications into PSPs that limit the number of products or only allow one or two products to be used or a preference, when this occurs follow the NCDOT Proprietary Product Guidelines to ensure G.S. 133-3 compliance.

## 15.4 Quantity Calculations

A major step in preparing an engineer's estimate involves computing the quantities of the previously identified pay items. Calculation of Quantities Sheets are required to document all roadway pay item quantities except for quantities shown in a summary in the Right of Way Plan Set and Contract Roadway Design Plans. NCDOT's standard Calculation of Quantities Sheets can be downloaded from the [Contracts Resources](#) page of the Connect NCDOT website. Note that Calculation of Quantities Sheets are revised periodically to correspond to updates to the [NCDOT Standard Specifications for Roads and Structures](#).



Copy all relevant spreadsheets to the project server for use in preparing cost estimates. The pay item spreadsheets contain built in macros and formulas to assist the designer in calculating the quantities. Pay particular attention to the units of the input data such as linear feet (LF), square yard (SY), and when entering information into the spreadsheets. The spreadsheets can be modified to suit project needs, but take care to ensure all formulas remain sound. Obtain approval from the Plans and Standards Engineer prior to making changes to the formulas or format of a Calculation of Quantities Sheet.

In preparing conceptual construction cost estimates, standard Calculation of Quantities Sheets are not required since the units used for the pay items on a Conceptual Construction Estimate may differ from those on the Initial Design, Plan-in-Hand, and Final Construction Quantities for Roadway Plans. The roadway designer has the option of creating their own calculation sheets for estimating the quantities for the Conceptual Construction Estimate. Document all pay item quantities and assumptions associated with the Conceptual Construction Estimate.

When preparing construction quantities for the Initial Design Estimate in the Alignment Defined Phase, the roadway designer is encouraged to begin preparing standard Calculation of Quantities Sheets for all roadway pay items. These calculation sheets can be modified and reused in the preparation of the construction quantities for the Plan-in-Hand Estimate and the Final Construction Quantities for Roadway Plans.

Calculation sheets are required when preparing the Plan-in-Hand Estimate and the Final Construction Quantities for Roadway Plans.

Note that section numbers referenced on the Calculation of Quantities Sheets correlate to the section numbers shown on the NCDOT Master Pay Item List, the standard number in the NCDOT Roadway Standard Drawings, and the section in the NCDOT Standard Specifications for Roads and Structures. For example, curb and gutter is listed under Section 846 on the pay item list. The standard drawing number for concrete curb and gutter is 846.01, and Section 846 of the NCDOT Standard Specifications for Roads and Structures pertains to concrete curb and gutter.

Refer to any summary tables included in the roadway plans (such as Earthwork Summary, Drainage Summary, Guardrail Summary, Geotechnical Summary, Shoulder Drain Summary, and Fencing Summary) for roadway pay items and quantities. Refer also to the Pavement Design, Geotechnical Recommendations, the Field Inspection letters, questions, and other unit recommendations to ensure all pay item quantities are included in the estimate. Quantities recommended by other units or the Division should be noted accordingly on the Calculation of Quantities Sheets.

There are hundreds of potential roadway pay items that the roadway designer may need to include in a construction cost estimate. Some examples of commonly missed pay items and quantities include temporary pavement and temporary shoring which are referenced in the Traffic Management Plans. The following sections provide additional guidance to aid the roadway designer in identifying various unique pay items and calculating quantities.

### 15.4.1 Earthwork

Borrow Excavation and Unclassified Excavation are the two primary earthwork pay items the roadway designer is responsible for estimating. Earthwork quantities are typically major pay items that comprise a significant percentage of the total cost of the project. Care should be given when estimating the Borrow Excavation and Unclassified Excavation pay items. Undercut Excavation is also a common earthwork pay item but is not typically considered a major pay item. A brief description of these pay items is as follows:

- **Borrow Excavation** – suitable material, obtained from sources outside the project limits, that is used to construct the embankment. Refer to [Section 230](#) of NCDOT Standard Specifications for Roads and Structures.
- **Unclassified Excavation** – excavation of all materials, including rock materials, within the project limits. Suitable Unclassified Excavation can typically be incorporated back into the project to construct the embankment as recommended by the Geotechnical Engineering Unit. Unsuitable Unclassified Excavation will typically be hauled away from the project as waste but may be incorporated into the project as directed by the Geotechnical Engineering Unit and the Division Engineer or representative. Refer to [Section 225](#) of NCDOT Standard Specifications for Roads and Structures.
- **Undercut Excavation** – excavation of unsuitable materials within the project limits and occurs when the natural soil materials below the subgrade or embankment are deemed undesirable. The quantity of Undercut Excavation will be provided in the Geotechnical Recommendations for Design and Construction. Undercut Excavation can occur in both cut and fill areas. Undercut Excavation is typically wasted and hauled away from the project. The waste material from Undercut Excavation is typically not used to construct embankments. Refer to [Section 225](#) and [Section 226](#) of NCDOT Standard Specifications for Roads and Structures. When Undercut Excavation is included in the construction estimate, an equivalent quantity of Select Granular Material (in cubic yards) may need to be added to the estimate as specified in the Geotechnical Recommendations for Design and Construction. If Select Granular Material is not specified, then the undercut area will need to be backfilled with Borrow Excavation or suitable Unclassified Excavation.

#### 15.4.1.1 Earthwork Balance Sheet

The primary purpose of an earthwork balance sheet is to provide a detailed breakdown of the excavation, embankment, borrow, and waste quantities associated with each typical section alignment. An earthwork balance sheet should be placed on the project's Preconstruction Team Site on Connect NCDOT in a Roadway Supporting Documentation folder located in LET Preparation/Final Plans. The roadway designer is responsible for furnishing a copy to the Geotechnical Engineering Unit on projects with available subsurface plans. Adhere to the following guidelines when preparing the earthwork balance sheet.

Breakdown quantities as follows:

1. Summary points at every 3,000 feet ±.
2. Summary points end/begin at each bridge (stream or grade separation).
3. Summary points end/begin near each major at-grade multilane intersection or at-grade railroad crossing.
4. Separate -Y- line, ramp, loop, and other major construction items from mainline earthwork, but include in the respective summary.
5. On widening projects, provide respective summaries for the right and left side if the material cannot be hauled across traffic. Coordinate with the Division Construction Engineer and Work Zone Traffic Control Unit to determine if earthwork materials can be hauled across traffic, and document as a design decision.
6. On existing divided facilities to be widened, provide respective summaries for right side, left side, and median widening if the material cannot be hauled across traffic. Coordinate with the Division Construction Engineer and Work Zone Traffic Control Unit



to determine if earthwork materials can be hauled across traffic, and document as a design decision.

7. Projects with complex construction phasing plans may require phasing of the summary points. Traffic Management Plans with multiple phases and steps will typically require the earthwork balance sheet to be broken down by traffic control phase. A good rule of thumb to follow is when one phase of construction needs to be completed prior to constructing the next phase, differentiate the summary points by the construction phasing on the earthwork balance sheet. Coordinate with the Division Construction Engineer and the Work Zone Traffic Control Unit to determine the phasing of the summary points. Not taking the construction phasing into account can lead to significant errors in the Unclassified Excavation, Borrow Excavation, and waste quantities.

Include recommendations from the Geotechnical Engineering Unit as follows:

1. Shrinkage Factor – Refer to Figure 15-1 when the shrinkage factor is not provided by the geotechnical engineer. The shrinkage factor is applicable to soil and weathered rock. Refer to the Geotechnical Recommendations for Design and Construction to determine if weathered rock is present on the project.
2. Loss Due to Clearing and Grubbing – Estimate a volume for loss of unclassified material in cuts of up to 1-foot in depth that result from clearing and grubbing operations. Any loss in fills is included in the shrinkage factor. The loss due to clearing and grubbing volume will be provided in the Geotechnical Recommendations for Design and Construction.
3. Undercut Excavation – Consider excavating benches at grade points and removing unsuitable material below subgrade. This normally should be wasted, but in certain conditions can be used in embankment as directed by the geotechnical engineer. The Undercut Excavation volumes will be provided in the Geotechnical Recommendations for Design and Construction.
4. Topsoil on Borrow Pits – On projects requiring borrow material, calculate an additional 5 percent of the total borrow for replacing the topsoil on the borrow pit.
5. Rock – Hard rock is only shown on the earthwork balance sheet. Use all rock on the project in embankments before using suitable excavation. Calculate the rock quantity on a one-to-one basis unless the Geotechnical Recommendations for Design and Construction recommends a rock swell factor. For projects with large amounts of hard rock, specify a swell factor for hard rock in addition to the shrinkage factor for earth materials. The rock swell factor will increase the volume of rock incorporated into the embankment or hauled away as waste.

Figure 15-2 shows a blank earthwork balance sheet with numbered columns ranging from 1 to 16. The numbers in the columns correspond to the descriptions listed below.

1. Excavation – Quantities include all rock excavation, Unclassified Excavation (suitable and unsuitable), and Undercut Excavation. All rock excavation is incidental to the Unclassified Excavation.
  - a. Column 1: the survey line reference and beginning station for each summary point.
  - b. Column 2: the ending station for each summary point.

- c. Column 3: the volume of all material excavated between summary point stations (except material covered by other excavation pay items such as Undercut Excavation and Drainage Ditch Excavation).
  - d. Column 4: the volumes of hard rock excavated as a part of Unclassified Excavation.
  - e. Column 5: the volume of material excavated beneath the roadway subgrade (i.e., Undercut Excavation).
  - f. Column 6: the volume of any Unclassified Excavation not suitable for roadway embankments.
  - g. Column 7: the volume of Unclassified Excavation (less hard rock) suitable for constructing roadway embankments.
2. Embankment – The total amount of material needed to construct the project.
- a. Column 8: the total embankment (including backfill for undercut). Column 8 represents the volume of all the different materials required to construct the embankment. Do not include shrinkage or swell factors in the total embankment volumes.
  - b. Column 9: the volume of embankment to be constructed from hard rock. Use the hard rock portion of Unclassified Excavation, before the earth, to construct embankments within each summary point.
  - c. Column 10: the volume of embankment to be constructed from earth.
  - d. Column 11: the actual volume of material needed to construct the embankment. Apply a shrinkage factor to the earth portion, then add the hard rock, if applicable. Shrinkage and swell factors do not apply to hard rock unless specified by the Geotechnical Engineering Unit.
3. Borrow – The total amount of material needed to construct the embankment from an approved borrow source.
- a. Column 12: the amount of borrow material needed to construct embankments after the suitable excavation (rock and earth) has been utilized within the summary points. The borrow column lists the volume of Borrow Excavation required to construct the embankment.
4. Waste – The portion of excavated material that cannot be incorporated into the project. Waste material is typically hauled away from the project, but suitable waste can be incorporated back into the project to replace borrow.
- a. Column 13: any hard rock excavation not utilized in embankments.
  - b. Column 14: the volume of any suitable excavation (undercut or unclassified) not utilized in embankments, excluding hard rock.
  - c. Column 15: the volume of excavation (unclassified or undercut) that does not have the necessary properties to be used in embankments.
  - d. Column 16: the summation of volumes recorded in columns 13, 14, and 15.

After the listing of the summary points is complete, total each respective column 3 through 16 and make earthwork adjustments after the TOTAL as described below. See Figure 15-3 (Borrow Project Example) and Figure 15-4 (Waste Project Example) for examples of the earthwork

adjustments listed below. Please note that the earthwork balance sheet examples shown in Figure 15-3 and Figure 15-4 do not involve rock swell factors.

1. Material for Shoulder Construction – Borrow projects with graded shoulder sections require line adjustments in Columns 8 and 10 to add volumes for any shoulder material not included with the Total and Earth embankment volumes in the body of the earthwork balance sheet. Apply the shrinkage factor to the volumes shown in Columns 11 and 12. Curb and gutter or shoulder trench sections do not require an adjustment. For projects with enough usable waste material to build the graded shoulder section, include a separate pay item of Shoulder Borrow to reflect that volume. Do not use a Shoulder Borrow pay item on projects with a Borrow Excavation pay item. Do not include shoulder borrow as an adjustment within the earthwork balance sheet. Show the Shoulder Borrow at the bottom of the sheet (below the Grand Total row).
2. Loss Due to Clearing and Grubbing – Deduct volumes recommended by the Geotechnical Engineering Unit from Columns 3 and 7. On waste projects, also deduct this volume from Columns 14 and 16. On borrow projects, also add this volume to Column 12.
3. Additional Undercut – Include undercut not shown on plans (such as grade point undercut or contingency undercut) that requires an earthwork adjustment line when undercut is shown within the summary points. The contingency undercut referenced in the Geotechnical Recommendations for Design and Construction is the most common type of additional undercut. List this volume in Columns 5, 8, 10, 15, and 16. If the undercut is suitable, list this volume in Column 14 instead of 15. Increase the volumes listed in Columns 11 and 12 by the shrinkage factor. For projects with no undercut shown within the summary points, list this volume as additional undercut at the bottom of the sheet and not as an adjustment.
4. Rock Waste to Replace Borrow – When hard rock waste is used to replace borrow, add the volume of rock in Column 9 and deduct the volume from Columns 10, 12, 13, and 16.
5. Adjust for Rock Waste – Use this adjustment line when rock is used to replace borrow. Hard rock is not subject to the shrinkage factor. Since the hard rock is being used to replace borrow that was calculated using a shrinkage factor, apply the shrinkage factor to the volume of rock used to replace borrow. For example, for a project with 20 percent shrinkage, multiply the volume by 0.20. Deduct the resulting volume from Columns 11 and 12 because the shrinkage factor was applied to the material within the summary points.
6. Waste in Lieu of Borrow – Deduct any earth waste to replace borrow from Columns 12, 14, and 16. Do not include any structural excavation when estimating the waste in lieu of borrow quantity or as a separate adjustment on the earthwork balance sheet. Structural pay items (such as Unclassified Structure Excavation and Culvert Excavation) are not included in the roadway estimate.

Additional earthwork adjustments such as select borrow or rock swell, may be warranted on select projects. The method of including this information on the earthwork balance sheet can vary. When the geotechnical engineer specifies Select Granular Material be used to backfill any Undercut Excavation and Borrow Excavation was used to backfill the Undercut on the earthwork balance sheet, add an adjustment for Select Granular Material In Lieu of Borrow to reduce the borrow quantity.

Contact the State Plans and Standards Engineer in the Contract Standards and Development Unit with any questions regarding the earthwork balance sheet or earthwork adjustments on the earthwork balance sheet.

After all adjustments are complete, total each respective column, 3 through 16, to provide the resulting Project Total for each column shown on the earthwork balance sheet.

If executed properly, the earthwork balance sheet will show that the excavation is either incorporated back into the project to construct the embankment or hauled away from the project as waste. A simple equation can be used to confirm the earthwork calculations properly balance.

- $\text{Total Unclassified Excavation} + \text{Undercut} + \text{Borrow} = \text{Embankment (+\%)} + \text{Total Waste}$

This equation should work on all subtotals, total, and project totals on borrow projects, but will not work on the grand total after adding the borrow to replace topsoil on the borrow pits. This equation should also work on all subtotals, totals, and grand totals on waste projects. Borrow projects can be defined as projects that include a quantity of Borrow Excavation. Waste projects can be defined as projects that do not include a quantity of Borrow Excavation and include a quantity of Waste material.

Borrow projects require an additional 5 percent added to the total borrow quantity in Column 12 of the Project Total line. This is an estimate for replacing the topsoil on the borrow pits that must be accounted for in the Grand Total on borrow projects. See Figure 15-3 for an example.

List Say quantities beneath the Grand Totals for any volumes shown in columns that require a pay item. The say value can include quantities for Total Unclassified Excavation, Undercut Excavation, and Borrow Excavation.

Include the following note on each earthwork balance sheet:

“Note: Earthwork quantities are calculated by the roadway designer. These quantities are based in part on subsurface data provided by the geotechnical engineer.”

List the estimated drainage ditch excavation, shoulder borrow, shallow undercut, Class IV subgrade stabilization and contingency undercut excavation quantities below the earthwork balance sheet. If undercut by station range is specified in the geotechnical report, any contingency undercut should be included with the additional undercut in the adjustments in the body of the earthwork balance sheet.

Refer to Figure 15-3 for an example of an earthwork balance sheet for a borrow project and Figure 15-4 for an example sheet for a waste project.

Figure 15-1 Shrinkage Factors

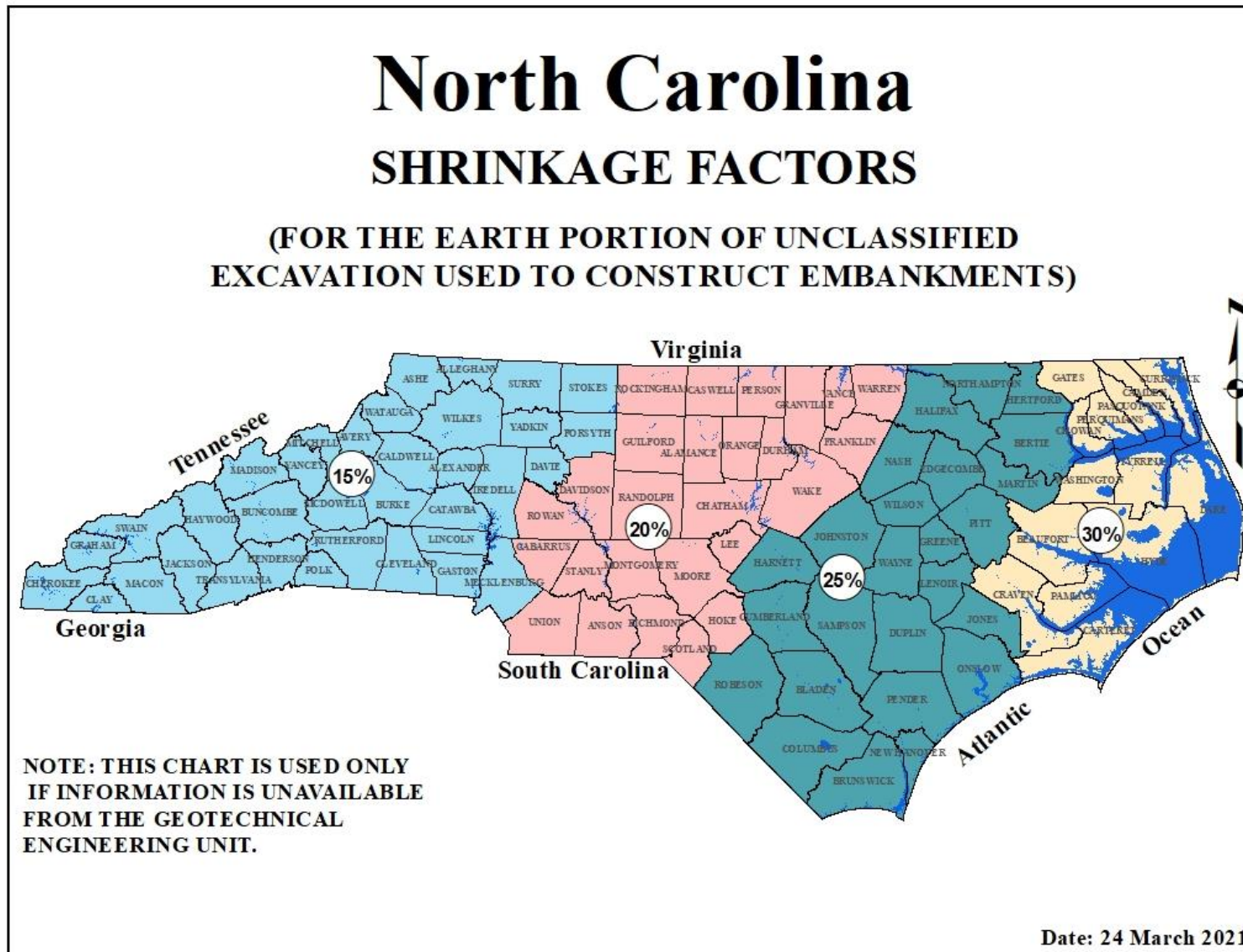



Figure 15-2 Blank Earthwork Balance Sheet

### Earthwork Balance Sheet

Volumes in Cubic Yards

PROJECT: \_\_\_\_\_ COUNTY: \_\_\_\_\_ DATE: \_\_\_\_\_ COMPILED BY: \_\_\_\_\_ SHEET \_\_\_ OF \_\_\_ SHEETS

STATION	STATION	EXCAVATION					EMBANKMENT				BORROW	WASTE			
		TOTAL UNCLASS.	ROCK	UNDERCUT	UNSUIT. UNCLASS.	SUITABLE UNCLASS.	TOTAL	ROCK	EARTH	EMBANK. (+) %		ROCK	SUITABLE	UNSUIT.	TOTAL
1	2	3	4	5	6	7	8	9	10	11	12	13	14	15	16
	<b>SUBTOTAL</b>														
	<b>SUBTOTAL</b>														
	<b>TOTAL</b>														
	MATERIAL FOR SHOULDER CONSTRUCTION														
	LOSS DUE TO CLEARING & GRUBBING														
	ADDITIONAL UNDERCUT														
	ROCK WASTE TO REPLACE BORROW														
	ADJUST FOR ROCK WASTE														
	WASTE IN LIEU OF BORROW														
	<b>PROJECT TOTAL</b>														
	EST. 5% TO REPLACE TOP SOIL ON BORROW PIT														
	<b>GRAND TOTAL</b>														
	<b>SAY</b>														

NOTE: EARTHWORK QUANTITIES ARE CALCULATED BY THE ROADWAY DESIGNER. THESE EARTHWORK QUANTITIES ARE BASED IN PART ON SUBSURFACE DATA PROVIDED BY THE GEOTECHNICAL ENGINEERING UNIT.

EST. DDE = X,XXX CUBIC YARDS  
 SHOULDER BORROW = X,XXX CUBIC YARDS  
 EST. SHALLOW UNDERCUT = X,XXX CUBIC YARDS  
 EST. SHALLOW UNDERCUT BY STATIONS = X,XXX CUBIC YARDS  
 TOTAL SHALLOW UNDERCUT = X,XXX CUBIC YARDS  
 CLASS IV SUBGRADE STABILIZATION = X,XXX TONS  
 PER GEOTECH RECOMMENDATION, ESTIMATED X,XXX CUBIC YARDS OF UNDERCUT TO BE USED AT THE DISCRETION OF THE RESIDENT ENGINEER.

Figure 15-3 Borrow Project Example

### Earthwork Balance Sheet

Volumes in Cubic Yards

PROJECT: \_\_\_\_\_ COUNTY: \_\_\_\_\_ DATE: \_\_\_\_\_ COMPILED BY: \_\_\_\_\_ SHEET \_\_ OF \_\_ SHEETS

STATION	STATION	EXCAVATION					EMBANKMENT				BORROW	WASTE			
		TOTAL UNCLASS.	ROCK	UNDERCUT	UNSUIT. UNCLASS.	SUITABLE UNCLASS.	TOTAL	ROCK	EARTH	EMBANK. +20%		ROCK	SUITABLE	UNSUIT.	TOTAL
L 120+00	150+00	60,000	5,000	3,000	7,000	48,000	75,000	5,000	70,000	89,000	36,000			10,000	10,000
Y1 10+00	20+00	10,000				10,000	8,000		8,000	9,600			400		400
<b>SUBTOTAL</b>		<b>70,000</b>	<b>5,000</b>	<b>3,000</b>	<b>7,000</b>	<b>58,000</b>	<b>83,000</b>	<b>5,000</b>	<b>78,000</b>	<b>98,600</b>	<b>36,000</b>		<b>400</b>	<b>10,000</b>	<b>10,400</b>
L 150+00	180+00	50,000	10,000			40,000	7,000	7,000		7,000			3,000	40,000	43,000
<b>SUBTOTAL</b>		<b>50,000</b>	<b>10,000</b>			<b>40,000</b>	<b>7,000</b>	<b>7,000</b>		<b>7,000</b>			<b>3,000</b>	<b>40,000</b>	<b>43,000</b>
L 180+00	210+00	40,000			8,000	32,000	80,000		80,000	96,000	64,000			8,000	8,000
Y2 20+00	30+00	20,000		7,000		20,000	25,000		25,000	30,000	10,000			7,000	7,000
<b>SUBTOTAL</b>		<b>60,000</b>		<b>7,000</b>	<b>8,000</b>	<b>52,000</b>	<b>105,000</b>		<b>105,000</b>	<b>126,000</b>	<b>74,000</b>			<b>15,000</b>	<b>15,000</b>
<b>TOTAL</b>		<b>180,000</b>	<b>15,000</b>	<b>10,000</b>	<b>15,000</b>	<b>150,000</b>	<b>195,000</b>	<b>12,000</b>	<b>183,000</b>	<b>231,600</b>	<b>110,000</b>		<b>3,000</b>	<b>40,400</b>	<b>68,400</b>
MATERIAL FOR SHOULDER CONSTRUCTION							12,000		12,000	14,400	14,400				
LOSS DUE TO CLEARING & GRUBBING		-5,000				-5,000					5,000				
ADDITIONAL UNDERCUT				5,000			5,000		5,000	6,000	6,000			5,000	5,000
ROCK WASTE TO REPLACE BORROW								3,000	-3,000		-3,000		-3,000		-3,000
ADJUST FOR ROCK WASTE										-600	-600				
WASTE IN LIEU OF BORROW											-40,400		-40,400		-40,400
<b>PROJECT TOTAL</b>		<b>175,000</b>	<b>15,000</b>	<b>15,000</b>	<b>15,000</b>	<b>145,000</b>	<b>212,000</b>	<b>15,000</b>	<b>197,000</b>	<b>251,400</b>	<b>91,400</b>			<b>30,000</b>	<b>30,000</b>
EST. 5% TO REPLACE TOP SOIL ON BORROW PIT											4,570				
<b>GRAND TOTAL</b>		<b>175,000</b>	<b>15,000</b>	<b>15,000</b>	<b>15,000</b>	<b>145,000</b>	<b>212,000</b>	<b>15,000</b>	<b>197,000</b>	<b>251,400</b>	<b>95,970</b>			<b>30,000</b>	<b>30,000</b>
<b>SAY</b>		<b>175,500</b>		<b>15,000</b>							<b>96,500</b>				

NOTE: EARTHWORK QUANTITIES ARE CALCULATED BY THE ROADWAY DESIGNER. THESE EARTHWORK QUANTITIES ARE BASED IN PART ON SUBSURFACE DATA PROVIDED BY THE GEOTECHNICAL ENGINEERING UNIT.

- EST. DDE = X,XXX CUBIC YARDS
- EST. SHALLOW UNDERCUT = X,XXX CUBIC YARDS
- EST. SHALLOW UNDERCUT BY STATIONS = X,XXX CUBIC YARDS
- TOTAL SHALLOW UNDERCUT = X,XXX CUBIC YARDS
- CLASS IV SUBGRADE STABILIZATION = X,XXX TONS

Figure 15-4 Waste Project Example

### Earthwork Balance Sheet

Volumes in Cubic Yards

PROJECT: \_\_\_\_\_ COUNTY: \_\_\_\_\_ DATE: \_\_\_\_\_ COMPILED BY: \_\_\_\_\_ SHEET\_\_ OF \_\_ SHEETS

STATION	STATION	EXCAVATION					EMBANKMENT				BORROW	WASTE			
		TOTAL UNCLASS.	ROCK	UNDERCUT	UNSUIT. UNCLASS.	SUITABLE UNCLASS.	TOTAL	ROCK	EARTH	EMBANK. +20%		ROCK	SUITABLE	UNSUIT.	TOTAL
L 220+00	250+00	75,000	10,000	5,000	1,000	64,000	60,000	10,000	50,000	70,000			4,000	6,000	10,000
Y10 15+00	25+00	8,000				8,000	10,000		10,000	12,000	4,000				
<b>SUBTOTAL</b>		<b>83,000</b>	<b>10,000</b>	<b>5,000</b>	<b>1,000</b>	<b>72,000</b>	<b>70,000</b>	<b>10,000</b>	<b>60,000</b>	<b>82,000</b>	<b>4,000</b>		<b>4,000</b>	<b>6,000</b>	<b>10,000</b>
L 250+00	280+00	14,000	2,000			12,000	20,000	2,000	18,000	23,600	9,600				
<b>SUBTOTAL</b>		<b>14,000</b>	<b>2,000</b>			<b>12,000</b>	<b>20,000</b>	<b>2,000</b>	<b>18,000</b>	<b>23,600</b>	<b>9,600</b>				
L 280+00	310+00	80,000			12,000	68,000	40,000		40,000	48,000			20,000	12,000	32,000
Y11 27+00	39+00	20,000	1,000	7,000		19,000	3,000	1,000	2,000	3,400			16,600	7,000	23,600
<b>SUBTOTAL</b>		<b>100,000</b>	<b>1,000</b>	<b>7,000</b>	<b>12,000</b>	<b>87,000</b>	<b>43,000</b>	<b>1,000</b>	<b>42,000</b>	<b>51,400</b>			<b>36,600</b>	<b>19,000</b>	<b>55,600</b>
<b>TOTAL</b>		<b>197,000</b>	<b>13,000</b>	<b>12,000</b>	<b>13,000</b>	<b>171,000</b>	<b>133,000</b>	<b>13,000</b>	<b>120,000</b>	<b>157,000</b>	<b>13,600</b>		<b>40,600</b>	<b>25,000</b>	<b>65,600</b>
MATERIAL FOR SHOULDER CONSTRUCTION LOSS DUE TO CLEARING & GRUBBING		-5,000				-5,000							-5,000		-5,000
ADDITIONAL UNDERCUT				5,000			5,000		5,000	6,000	6,000			5,000	5,000
ROCK WASTE TO REPLACE BORROW															
ADJUST FOR ROCK WASTE WASTE IN LIEU OF BORROW											-19,600		-19,600		-19,600
<b>PROJECT TOTAL</b>		<b>192,000</b>	<b>13,000</b>	<b>17,000</b>	<b>13,000</b>	<b>166,000</b>	<b>138,000</b>	<b>13,000</b>	<b>125,000</b>	<b>163,000</b>			<b>16,000</b>	<b>30,000</b>	<b>46,000</b>
<b>GRAND TOTAL</b>		<b>192,000</b>	<b>13,000</b>	<b>17,000</b>	<b>13,000</b>	<b>166,000</b>	<b>138,000</b>	<b>13,000</b>	<b>125,000</b>	<b>163,000</b>			<b>16,000</b>	<b>30,000</b>	<b>46,000</b>
<b>SAY</b>		<b>192,500</b>		<b>17,000</b>											

NOTE: EARTHWORK QUANTITIES ARE CALCULATED BY THE ROADWAY DESIGNER. THESE EARTHWORK QUANTITIES ARE BASED IN PART ON SUBSURFACE DATA PROVIDED BY THE GEOTECHNICAL ENGINEERING UNIT.

EST. DDE = X,XXX CUBIC YARDS  
 SHOULDER BORROW = X,XXX CUBIC YARDS  
 EST. SHALLOW UNDERCUT = X,XXX CUBIC YARDS  
 EST. SHALLOW UNDERCUT BY STATIONS = X,XXX CUBIC YARDS  
 TOTAL SHALLOW UNDERCUT = X,XXX CUBIC YARDS  
 CLASS IV SUBGRADE STABILIZATION = X,XXX TONS



This page intentionally left blank.

## 15.4.2 Geotechnical Recommendations for Design and Construction

The Geotechnical Recommendations for Design and Construction is an important resource to the roadway designer in calculating earthwork quantities and related pay items. The information found in the recommendations will affect typical sections and numerous pay items. The geotechnical recommendations are divided into five primary sections, (I) Slope/Embankment Stability, (II) Subgrade Stability, (III) Borrow Specifications, (IV) Miscellaneous, and (V) Summary of Quantities for Pay Items.

Refer to the [NCDOT Geotechnical Investigation and Recommendations Manual](#), for more detailed information regarding the Geotechnical Unit's roadway recommendations.

### 15.4.2.1 (I) Slope/Embankment Stability

The Slope/Embankment Stability section in the Geotechnical Recommendations for Design and Construction may contain the following information:

1. Slope Design
  - a. The recommended steepest slopes (cut and fill) that will be stable.
  - b. Other recommendations can include:
    - i. Undercut excavation.
    - ii. Wick drains.
    - iii. Surcharges.
    - iv. Grade revisions.
    - v. Ponds within construction limits.
    - vi. Rock embankments in water.
    - vii. Geotextile for soil stabilization.

### 15.4.2.2 (II) Subgrade Stability

The Subgrade Stability section in the Geotechnical Recommendations for Design and Construction may contain the following information:

1. Subsurface Drainage
  - a. Subsurface Drain ([NCDOT Roadway Standard Drawings](#) Std. No. 815.02). Use the Subsurface Drains Calculation of Quantities Sheet when estimating quantities for subsurface drains.
    - i. Either 4-inch or 6-inch as specified in the geotechnical recommendations. 6-inch perforated subdrain pipe is standard unless specified otherwise.
  - b. Underdrain ([NCDOT Roadway Standard Drawings](#) Std. No. 815.03). Use the Underdrains Subsurface Calculation of Quantities Sheet when estimating quantities for underdrains and blind drains. Note that blind drains do not include a pay item for perforated subdrain pipe.
    - i. Either 4-inch or 6-inch as specified in the geotechnical recommendations. 6-inch perforated subdrain pipe is standard.

2. Other recommendations can include:
  - a. Grade point undercut.
  - b. Undercut for subgrade stability.
  - c. Aggregate subgrade (Type 1 and 2).
  - d. Geotextile for soil stabilization.

#### 15.4.2.3 (III) Borrow Specifications

The Borrow Specifications section in the Geotechnical Recommendations for Design and Construction may contain the following information:

1. Recommendations for the disposal of waste materials (rock, soil, and unsuitable materials)
2. Borrow Criteria
3. Shrinkage Factor
  - a. Shrinkage factors typically range from 15 percent in the mountains to 30 percent in the eastern Coastal Plains. See Figure 15-1 to estimate shrinkage factors based on region when geotechnical recommendations are not available.
4. Rock Swell Factor
  - a. A percentage of the anticipated rock swell on a particular project
5. Select Granular Material
  - a. The geotechnical recommendations will provide estimated quantities of either Class II or Class III Select Granular Material needed to backfill previous geotechnical recommendations (i.e., Undercut Excavation).
6. Boulevard Ditches

#### 15.4.2.4 (IV) Miscellaneous

The Miscellaneous section in the Geotechnical Recommendations for Design and Construction may contain the following information:

1. Reduction of Unclassified Excavation due to clearing and grubbing
  - a. See adjustment for Loss Due to Clearing and Grubbing on the earthwork balance sheet.
2. Reduction of Unclassified Excavation
  - a. Lists unsuitable Unclassified Excavation material within the project limits. Directions on whether this unsuitable material can be used in the embankment will be provided.
3. Water Wells
  - a. Lists the station and offset of all wells within the proposed right of way that need to be abandoned. Sealing Abandoned Wells shall be paid in accordance with [Section 205](#) of the NCDOT Standard Specifications for Roads and Structures.

4. Springs and Seeps
  - a. Lists the station and offset of all springs or seeps within the construction limits that will require spring boxes or other drainage. Spring boxes will be included in the drainage summary prepared by the drainage engineer. Coordinate with the drainage engineer and geotechnical engineer as needed.
5. Aesthetic or Environmental Concerns
  - a. Potential scenic sites and reclamation areas
6. Construction Procedures
  - a. Outlines materials and instrumentation for monitoring or inspection.
7. Potentially Hazardous Conditions
  - a. Abandoned wells
  - b. Petroleum odors
  - c. Underground storage tanks
  - d. Landfills
8. Ponds
  - a. Lists all ponds near cuts that may be affected by the lowering of the ground water table or change in the ground water flow regime
  - b. Lists all ponds that need to be drained or filled with select material
9. Rock
  - a. Lists all locations where rock may be ripped or blasted during excavation within the project limits
  - b. Lists areas requiring horizontal drains, rock bolt, rock fall protection, or containing acidic rock

#### 15.4.2.5 Summary of Quantities for Pay Items

The Geotechnical Recommendations for Design and Construction includes a Summary of Quantities for pay items. Confirm all quantities referenced in the summary reflect the quantities referenced in the geotechnical recommendations. Coordinate with the geotechnical engineer to resolve any discrepancies and clarify any recommendations.

The following information is typically provided in the summary:

1. Item number representing the AWP pay item identification number
2. Description of the pay item
3. Quantity and units of the pay item
4. Comments
5. Information that will impact earthwork quantities
  - a. Loss due to clearing and grubbing
  - b. Shrinkage factor
  - c. Rock swell

### 15.4.3 Geotechnical Recommendations for Pavement and Subgrade

Refer to the Geotechnical Recommendations for Pavement and Subgrade report, formerly known as the Geotechnical Recommendations for Pavement Design to identify several pay items and their quantities. The report is divided into three primary sections: Soil Type and Areas of Geotechnical Interest; Design and Construction Recommendations; and Summary of Quantities. This report may provide guidance on subgrade stability, blotting sand, and proof rolling.

#### 15.4.3.1 Subgrade Stability

When stabilized subgrade is specified in the Geotechnical Recommendations for Pavement and Subgrade report, include Subgrade Stabilization in the pavement schedule and on the applicable typical sections. Use the following widths for stabilization:

1. Width in curb and gutter sections – edge of pavement to edge of pavement
2. Width in shoulder sections – 1-foot outside the top edges of the full depth pavement structure (Include full depth paved shoulders)
3. Do not use chemical stabilization (lime or cement) on pavement less than 6 feet in width.

The most common subgrade stabilization types are as follows:

1. Lime stabilization – requires the pay item Lime Treated Soil (Slurry Method), Lime Treated Soil (Quicklime). Lime stabilization also requires pay items Lime for Lime Treated Soil, Asphalt Curing Seal, and Blotting Sand. A recommended quantity of Blotting Sand will be provided in the Pavement and Subgrade Investigation and Recommendations report. Lime Treated Soil pay items shall be paid in accordance with [Section 501](#) of the NCDOT Standard Specifications for Roads and Structures.
2. Cement stabilization – requires the pay items Soil Cement Base, Portland Cement for Soil Cement Base, Asphalt Curing Seal and Blotting Sand. The blotting sand quantity is shown in the Geotechnical Recommendations for Pavement and Subgrade Design. Soil-Cement Base shall be paid for in accordance with [Section 542](#) of the NCDOT Standard Specifications for Roads and Structures.
3. Aggregate Base Course – for the cement area requires the pay item Aggregate for Soil Cement Base. Use this pay item only when it is specified that a percentage of the cement stabilized area also requires aggregate base course. Aggregate for Soil Cement Base shall be paid for in accordance with [Section 542](#) of the NCDOT Standard Specifications for Roads and Structures.
4. Aggregate for Aggregate Stabilization – requires the pay item Stabilizer Aggregate. Aggregate stabilization shall be paid for in accordance with [Section 510](#) of the NCDOT Standard Specifications for Roads and Structures.

Aggregate subgrade, which is associated with shallow undercut, requires the pay item Class IV Subgrade Stabilization. Aggregate subgrade may be specified in lieu of chemical stabilization. Aggregate subgrade shall be paid for in accordance with [Section 505](#) of the NCDOT Standard Specifications for Roads and Structures. Additional pay items associated with aggregate subgrade can also include Shallow Undercut and Geotextile for Soil Stabilization.

Deviations from the Pavement and Subgrade Investigation and Recommendations shall be documented by the State Pavement Design Engineer in the Materials and Tests Unit.

The following Calculation of Quantities Sheets have been created to aid the roadway designer in estimating the various pay items related to subgrade stabilization:

- Aggregate for Soil Cement Base: AggSCB
- Asphalt Curing Seal: AsphaltCureSeal
- Blotting Sand: BlottingSand
- Lime Treated Soil: LimeTreatedSoil
- Lime for Lime Treated Soil: Lime4LimeTreatedSoil
- Portland Cement for Soil Cement Base: PortlandCTBC
- Soil Cement Base: SoilCementBase
- Stabilizer Aggregate: StabilizerAggregate and Class IV Aggregate Stabilization for Coastal Plain Sands

#### 15.4.3.2 Proof Rolling

Proof rolling is recommended by the Geotechnical Engineering Unit in the Geotechnical Recommendations for Pavement and Subgrade. When the pavement design recommendations are submitted to the roadway designer, proof rolling recommendations may be included. Discuss any recommendations for proof rolling at the Field Inspection. Use the Proof Rolling Calculation of Quantities Sheet when estimating quantities.

Perform proof rolling to a width of 2 feet outside the proposed top edges of full depth pavement. Compute proof rolling at the rate of 3 hours per 24-foot width of full depth pavement per mile. Prorate full depth pavement widths other than 24 feet to correspond with this unit measurement. Final payment shall be in accordance with [Section 260](#) of the NCDOT Standard Specifications for Roads and Structures.

Refer to the following for examples of computing hours per mile of proof rolling for various width pavements:

1. Example #1: 22-foot roadway width, with no paved shoulders.
  - a. 22 feet (two 11-foot lanes) + 4 feet (2-foot outside left & right full depth pavement) = 26-foot width.
  - b. 26-foot width x (3 hrs. per mile \ per 24-foot roadway width) = 3.25 hrs. per mile.
2. Example #2: 24-foot roadway width, With 2-foot full depth paved shoulders.
  - a. 24 feet (two 12-foot lanes) + 4 feet (2-foot full depth paved shoulders left & right) + 4 feet (2-foot outside left & right full depth pavement) = 32-foot width.
  - b. 32-foot width x (3 hrs. per mile \ per 24-foot roadway width) = 4.00 hrs. per mile.
3. Example #3: 60-foot roadway width, with 4-foot full depth paved shoulders.
  - a. 60 feet (five 12-foot lanes) + 8 feet (4-foot full depth paved shoulders left & right) + 4 feet (2-foot outside full depth pavement left & right) = 72-foot width.
  - b. 72-foot width x (3 hrs. per mile \ per 24-foot roadway width) = 9.00 hrs. per mile.

### 15.4.3.3 Summary of Quantities

The Geotechnical Recommendations for Pavement and Subgrade includes a Summary of Quantities listing the pay items and quantities. Confirm all quantities referenced in the summary reflect the quantities referenced in the geotechnical recommendations. Coordinate with the geotechnical engineer to resolve any discrepancies and clarify any recommendations. All quantities are in addition to any roadway quantities unless otherwise specified. The following information is typically provided in the summary:

1. Pay item number representing the master pay item number.
2. Pay item or quantity adjustment listing the pay item name.
3. Spec book section number or SP reference.
4. Report section listing the section in the Pavement and Subgrade Investigation and Recommendations that the pay item is referenced.
  - a. Alignment if applicable.
  - b. Begin and end stations.
  - c. Quantity of the pay item.
  - d. Unit of measurement.

### 15.4.4 Lump Sum Grading

Projects with a lump sum Grading pay item typically require less construction engineering manpower since field measurements are not required. Coordinate with the NCDOT Project Manager and Division Construction Engineer prior to deciding to use the lump sum grading pay item. Lump sum grading is generally warranted on small projects, like bridge replacement projects that do not have a significant amount of earthwork and other related pay items. Use the following guidelines to decide whether a project will be let on an individual item basis or lump sum grading basis. Final payment shall be in accordance with [Section 226](#) of the NCDOT Standard Specifications for Roads and Structures.

Prepare quantities in the traditional manner. Once these quantities are known, use the following guidance to decide the basis of letting the project:

Estimate the quantities for the items and extend prices as shown in Figure 15-5.

If the summation of the item amounts is \$1,000,000.00 or less, the grading may be let on a lump sum basis with concurrence from the Division Engineer or representative. If the cost of any one of the items, excluding clearing and grubbing and fine grading, is 50 percent or more of the total cost calculated, include that item as an individual item with the other items being done on a lump sum grading basis. An SP will be needed in this case. Indicate the Grading pay item as SP in the construction cost estimate. If the sum of the item amounts exceeds \$1,000,000.00 or is 25 percent or more of the total cost of the project, the project shall contain the individual items in accordance with the [NCDOT Standard Specifications for Roads and Structures](#).

Figure 15-5 Sample Bid Item Schedule

<u>ITEM</u>	<u>QUANTITIES</u>	<u>UNIT</u>	<u>UNIT PRICE</u>	<u>PRICE</u>
CLEARING AND GRUBBING	_____	ACRES	\$ 15,000.00	\$ _____
UNCLASSIFIED EXCAVATION	_____	YD <sup>3</sup>	\$ 10.00	\$ _____
BORROW EXCAVATION	_____	YD <sup>3</sup>	\$ 10.00	\$ _____
SHOULDER BORROW	_____	YD <sup>3</sup>	\$ 10.00	\$ _____
FINE GRADING	_____	YD <sup>2</sup>	\$ 4.00	\$ _____
REMOVAL OF EXISTING ASPHALT PAVEMENT	_____	YD <sup>2</sup>	\$ 6.00	\$ _____
REMOVAL OF EXISTING CONCRETE PAVEMENT	_____	YD <sup>2</sup>	\$ 15.00	\$ _____
BREAKING OF EXISTING ASPHALT PAVEMENT	_____	YD <sup>2</sup>	\$ 4.00	\$ _____
BREAKING OF EXISTING CONCRETE PAVEMENT	_____	YD <sup>2</sup>	\$ 8.00	\$ _____
			TOTAL	\$ _____

Other considerations for lump sum grading may use a dollar limit. When applicable, consider resurfacing, restoration, and rehabilitation projects with trenching and widening and minor grading when use of cross sections for earthwork by the Resident Engineer is not practical. When applying lump sum grading to these special applications, approval by the State Roadway Design Engineer and State Proposals and Specifications Engineer is required on a project-by-project basis.

Refer to RDM Part II Chapter 13 Section 13.7 for guidance on adding the lump sum grading note to the Earthwork Summary when the lump sum Grading pay item is included in the construction cost estimate.

### 15.4.5 Guardrail

As outlined in [NCDOT Roadside Safety Hardware – MASH-16 Implementation Plan](#), NCDOT is moving towards compliance with the 2016 edition of the *AASHTO Manual for Assessing Safety Hardware* (MASH-16) which will apply to all Interstate (I), United States (US), North Carolina (NC), and State Routes (SR) constructed or maintained by the Department. Standard guardrail and associated pay items shall be paid for in accordance with Sections [862](#), [863](#), and [864](#) of the NCDOT Standard Specifications for Roads and Structures.

Refer to [NCDOT Roadway Standard Drawings](#) Std. Nos. 862.01, 862.02, and 862.03 when identifying guardrail pay items.

Obtain both permanent and temporary guardrail quantities from the completed guardrail summary.



Refer to RDM Part II Chapter 13 Section 13.7.1.2 for additional information regarding the guardrail summary.

See Figure 15-6 and the following guardrail scenarios for common examples of how to populate a guardrail summary.

1. Protection at Median Bridge Piers ([NCDOT Roadway Standard Drawings](#), Std. No. 862.01 Sheet 1 of 11)
  - a. Assume:
    - i. 46-foot median with 12-foot median shoulders.
    - ii. 70 miles per hour design speed.
    - iii. B-77 anchors for single faced concrete barrier.
      - a) feet = face of guardrail to face of guardrail under bridge.
      - b)  $3 \text{ feet} + (2 \times 1.5) + (2 \times 0.28 \text{ feet}) = 6.56 \text{ feet}$   
Note: 3 feet = width of pier; 1.5 feet = width of barrier and offset;  
0.28 feet = width of guardrail
  - b. Feet – 2 feet = 4.56 feet. This is the width that has to be closed.  
Note: 2 feet = assumed width of impact attenuator  
(This is the narrowest width impact attenuator)
    - i. feet X 7.5 (assuming 15:1 taper on both sides) = 34.20 feet. Say 37.5 feet
    - ii. (Needs to be divisible by 12.5 feet)
  - c. 37.5-foot taper + 22.875 feet for B-77 = 60.375 feet per attachment. Say 62.5 feet  
(Needs to be divisible by 12.5 feet)
  - d. 250 feet of guardrail per bridge location (4 attachments @ 62.5 feet).
  - e. Two impact attenuator units (IA-MASH TL-3).
  - f. 60-foot interior bent spacing.
  - g. 120 feet of single face concrete barrier (60 feet x 2 sides of median piers).
2. Guardrail Approaching Dual Lane Bridge ([NCDOT Roadway Standard Drawings](#), Std. No. 862.01, Sheet 3 of 11)
  - a. Assume:
    - i. 46-foot median.
    - ii. 40-foot-wide bridges with 10-foot outside shoulders and 6-foot inside shoulders.
    - iii. Two 12-foot travel lanes in each direction.
    - iv. 70 miles per hour design speed.
    - v. Type III Structural Anchor Units at bridge.
    - vi. 100 feet of guardrail required by fill height on right shoulder on trailing end of bridge.

3. Guardrail at Two-Lane Two-Way Bridges ([NCDOT Roadway Standard Drawings](#), Std. No. 862.01, Sheet 4 of 11)
  - a. Assume:
    - i. 32-foot-wide bridge with 4-foot shoulders.
    - ii. Two 12-foot travel lanes.
    - iii. over 2,000 ADT (Design Year).
    - iv. 60 miles per hour design speed.
    - v. Type III Structural Anchor Units at bridge.
4. Guardrail at Bridges with 2'-6" Curb and Gutter and Sidewalk ([NCDOT Roadway Standard Drawings](#), Std. No. 862.01, Sheet 5 of 11)
  - a. Assume:
    - i. 64 feet face to face curb and gutter.
    - ii. 10-foot berm.
    - iii. 50 miles per hour design speed.
    - iv. Structural Anchor Units at bridge.
    - v. Bridge has three bar metal rails (for bicycle and pedestrian accommodations).
    - vi. Bridge is 175 feet in length.
5. Beginning of Guardrail in Cut or Fill ([NCDOT Roadway Standard Drawings](#), Std. No. 862.01, Sheet 6 of 11)
  - a. Assume:
    - i. Four-lane divided section.
    - ii. 70 miles per hour design speed.
    - iii. 12-foot outside shoulder.

#### 15.4.5.1 Additional Guardrail Posts

Include the pay item Additional Guardrail Post on all projects with guardrail pay items. Use engineering judgement to determine the appropriate quantities on a project-by-project basis. The following rules of thumb can be used to determine the quantity of additional posts:

- Steel beam guardrail quantity  $\leq$  1,000 LF: 5 additional guardrail posts
- Steel beam guardrail quantity  $>$  1,000 LF: 10 additional guardrail posts

#### 15.4.5.2 Extra Length Guardrail Posts

Extra length guardrail posts may be needed when guardrail is placed at the top of a retaining wall or where the offset from the face of guardrail to the hinge point of the fill slope does not comply with the [NCDOT Roadway Standard Drawings](#). Contact the State Plans and Standards Engineer in the Contract Standards and Development Unit to obtain the length of the extra length guardrail posts.

- Use 7-foot guardrail posts when the offset from the back of the guardrail post to the hinge point of the fill slope is 1-foot. Obtain a detail from the [State Plans and Standards Engineer](#).
- Use 8-foot guardrail posts when the back of the guardrail post is placed at the hinge point of the fill slope. Obtain a detail from the [State Plans and Standards Engineer](#).

#### 15.4.5.3 25-Foot Clear Span Guardrail

To allow guardrail posts to be driven and prevent damage, 25-Foot Clear Span Guardrail is an option when guardrail is placed across a reinforced box culvert or large diameter pipe with less than 4 feet of cover. Refer to [Details in Lieu of Standards](#) to obtain the special detail and coordinate with the structure designer to ensure consistency between plan sets. The 25-foot Clear Span Guardrail Sections pay item can be found on the Master Pay Item List (3140000000-E) and is paid for per each.

#### 15.4.5.4 Non-Standard Guardrail

It may be necessary to consider the use of non-standard guardrail. Non-standard guardrail will require a PSP and detail sheet. Contact the [State Plans and Standards Engineer](#) and the [State Proposals and Specifications Engineer](#) in the Contract Standards and Development Unit to obtain the detail sheet and PSP for any non-standard guardrail pay item. Common non-standard guardrail pay items include Weathered Steel Guardrail and Wooden Guardrail (when appropriate). Non-standard guardrail can be paid using an appropriate SP Generic Guardrail pay item.

#### 15.4.5.5 Guardrail Deductions

The length of guardrail listed in the Guardrail Summary includes the Steel Beam Guardrail and the structural and end unit anchors. The total length of guardrail needed at an installation is obtained by deducting the applicable structural and end unit anchor lengths from the total length. Round the total length of guardrail for each continuous section of guardrail so it is divisible by 12.5 feet. Anchor unit deductions, to be used in calculations, are found in Table 15-2 below.

**Table 15-2 Guardrail Anchor Deductions**

Anchor Deductions	
Anchor	Deductions (feet)
GREU TL-3	50
GREU TL-2	25
CAT-1	6.25
AT-1	6.25
Type III	18.75
B-77	22.875
B-83	25

Note: Due to varying lengths, Impact Attenuators are not included as an anchor deduction. The roadway engineer should determine any length restrictions for any proposed impact attenuators and clarify with notes on the roadway plans and remarks in the guardrail summary.

Figure 15-6 Guardrail Summary Examples

COMPUTED BY: _____		DATE: _____		DIVISION OF HIGHWAYS STATE OF NORTH CAROLINA																			PROJECT REFERENCE NO.	SHEET NO.												
CHECKED BY: _____		DATE: _____		GUARDRAIL SUMMARY																			G = GATING IMPACT ATTENUATOR TL-3 or TL-2 NG = NON-GATING IMPACT ATTENUATOR TL-3 or TL-2													
SURVEY LINE	BEG. STA.	END STA.	LOCATION	LENGTH			WARRANT POINT		"N" DIST. FROM E.O.L.	TOTAL SHOULDER WIDTH	FLARE LENGTH		W		ANCHORS							IMPACT ATTENUATOR		SINGLE FACED CONCRETE BARRIER	REMOVE EXISTING GUARDRAIL	REMOVE & STOCKPILE EXISTING GUARDRAIL	REMARKS									
				STRAIGHT	SHOP CURVED	DOUBLE FACED	APPROACH END	TRAILING END			APPROACH END	TRAILING END	APPROACH END	TRAILING END	Type III	B-77	GREU, TL-3	GREU, TL-2	CAT-1	AT-1	Type III SC	B-77 SC	IA-MASH TL-3					G	NG							
1	-L-	10+43.75	12+28.75	MED.	250			11+06.25	11+66.25	20	23	37.5	37.5	2.28	2.28		4																		120	
2	-L-	10+00.00	13+00.00	LT.	300			10+00.00		10	15	281.25		3				1		1																
	-L-	10+00.00	12+12.50	MED. LT.	212.5			10+00.00		6	23	193.75		16.92				1		1																
	-L-	10+00.00	11+87.50	MED. RT.	187.5			10+00.00	11+87.50	6	23		37.5		4			1		1																
	-L-	10+00.00	11+00.00	RT.	100			10+00.00	11+00.00	10	13							1			1															
3	-Y-	10+00.00	13+00.00	LT.	300			10+00.00		4	11	281.25		5				1		1																
	-Y-	10+00.00	11+37.50	RT.	137.5			10+00.00		4	11	118.75		2.38				1		1																
4	-Y-	10+00.00	12+25.00	RT.	225			12+25.00		7	10' BERM	50		1				1		1																
	-Y-	14+00.00	16+25.00	LT.	225			14+00.00		7	10' BERM	50		1				1		1																
5	-L-	10+00.00	20+00.00	LT.	1,000			18+50.00	10+00.00	12	15	50		1						1		1														
					LESS ANCHOR DEDUCTIONS																															
				Type III	8 @ 18.75' =	150																														
				B-77	4 @ 22.875' =	91.5																														
				GREU, TL-3	6 @ 50.00' =	300																														
				CAT-1	2 @ 6.25' =	6.25																														
				<b>TOTAL</b>		<b>2,390</b>																														
				<b>SAY =</b>	<b>2,400</b>																															
				(10 ADDITIONAL GUARDRAIL POSTS)																																

This page intentionally left blank.

### 15.4.6 Cable Guiderail

Cable Guiderail shall be paid for in accordance with [Section 865](#) of the NCDOT Standard Specifications for Roads and Structures and [NCDOT Roadway Standard Drawings](#) Std. No. 865.01. Obtain Cable Guiderail quantities from the completed guiderail summary.

Refer to RDM Part II Chapter 13 Section 13.7.1.2 for additional information regarding the guiderail summary.

#### 15.4.6.1 Additional Guiderail Posts

Include the pay item Additional Guiderail Posts on all projects that include the cable guiderail pay item. Use engineering judgement to determine the appropriate quantities on a project-by-project basis. Use the following rules of thumb to determine the quantity of additional posts:

- Guiderail quantity  $\leq$  10,000 LF: 25 additional guiderail posts
- Guiderail quantity  $>$  10,000 LF: 50 additional guiderail posts

### 15.4.7 Fencing

The roadway designer is responsible for estimating the quantity of any fencing within the projects right of way. Coordination with the structure designer may be needed for fencing located on bridges. The fencing on the bridge will not be the responsibility of the roadway designer. Woven wire and chain link are the standard types of fences used on NCDOT projects. Specialty fencing such as barbed wire fence, security fence, masonry walls, and different types of fencing used for screening and landscape purposes may be specified on a project-by-project basis.

Refer to RDM Part II Chapter 14 Section 14.6 for additional guidance on fencing.

Refer to [Section 866](#) in the NCDOT Standard Specifications for Roads and Structures for detailed information on construction methods, measurement, and payment.

#### 15.4.7.1 Woven Wire Fence

Woven Wire Fence, 47-Inch Fabric, measured per LF, is the standard woven wire fence pay item. Other standard pay items associated with woven wire fence include 4-inch Timber Fence Posts (7 feet 6 inches long), and 5-inch Timber Posts (8 feet long). Steel posts can also be specified if warranted but will require an SP. Coordinate with the NCDOT Project Manager, Division Engineer, and State Plans and Standards Engineer when specifying fence that does not meet the standard 47 inches or posts that vary from the standard.

Refer to [NCDOT Roadway Standard Drawings](#) Std. No. 866.02 and Std. No. 866.03 for detailed guidance on placing woven wire fence. The use of woven wire fence with steel posts is not common; discuss its use with the NCDOT Project Manager and Division Engineer.

Use the Fence\_WovenWire Calculation of Quantities Sheet when estimating quantities for woven wire fence. The calculation sheet contains formulas to estimate the number of 4-inch and 5-inch posts required based on the number of end, corner, and line brace posts.

- End brace posts are required at the terminus of any woven wire fence that does not tie to another existing line post.
- Line brace posts are typically spaced 14 feet apart and are placed between the end and corner brace posts.

- Corner brace posts are required when the corner angle is 15 degrees or greater.

#### 15.4.7.2 Additional Barbed Wire

Include pay item Additional Barbed Wire when the woven wire fence crosses a ditch.

Refer to the Detail of Ditch Crossing on [NCDOT Roadway Standard Drawings](#) Std. No. 866.02.

Use engineering judgement to determine the estimated quantity of Additional Barbed Wire needed per LF. The following rules of thumb can be used to estimate the quantity of additional wire:

- 20 LF of additional barbed wire per 1,000 LF of woven wire fence
- The minimum quantity of additional barbed wire on a project with woven wire fence is 20 LF

#### 15.4.7.3 Chain Link Fence

Chain Link Fence, 48-Inch Fabric, measured per LF, is the standard chain link fence pay item. Other standard pay items associated with chain link fence include Metal Line Posts for 48-Inch Chain Link Fence, and Metal Terminal Posts for 48-Inch Chain Link Fence. Coordinate with the NCDOT Project Manager, Division Engineer, and State Plans and Standards Engineer when specifying fence that does not meet the standard 48-inch height.

Refer to [NCDOT Roadway Standard Drawings](#) Std. No. 866.01 (Chain Link Fence – 4 feet, 5 feet, and 6 feet high) for detailed guidance on placing chain link fence.

Use the Fence\_ChainLink Calculation of Quantities Sheet when estimating quantities for chain link fence. The calculation sheet contains formulas to estimate the number of line and terminal posts required based on the number of end, corner, and line brace posts.

- End brace posts are required at the terminus of any woven wire fence that does not tie to another existing line post.
- Line brace posts are typically spaced 8 feet apart and are placed between the end and corner brace posts.
- Corner brace posts are required when the corner angle is greater than 30 degrees.

#### 15.4.7.4 Specialty Fence

The types of specialty fence can vary, but barbed wire fence and security fence are most commonly used. For barbed wire fence, use the standard pay item for Strand Barbed Wire Fence with Posts measured per LF and [NCDOT Roadway Standard Drawings](#) Std. No. 866.04. All other specialty fencing will require an SP and special detail.

#### 15.4.7.5 Gates

Approved gates shall be paid for in accordance with [Section 866](#) of the NCDOT Standard Specifications for Roads and Structures. The standard pay items are for double and single gates per each.

Refer to RDM Part II Chapter 14 Section 14.9 for additional guidance on gates.

- For single gates, the gate width and opening dimension are identical.
- For double gates, the gate width is half the opening size.

## 15.4.8 Drainage

The roadway designer is responsible for including all drainage related pay items in the roadway quantity estimates. Drainage related pay items will be listed in a Drainage Summary (when available) or drainage report provided by the hydraulics engineer. Coordinate with the hydraulics engineer to resolve any questions related to drainage pay items.

### 15.4.8.1 Rip Rap

Rip Rap quantities are typically provided by the hydraulics engineer. If rip rap quantities from the hydraulics engineer are not available during the early stages of plan development, use a rate of 100 pounds per cubic foot to estimate the quantity of rip rap. Refer to [NCDOT Roadway Standard Drawings](#) Std. 876.02 for quantities of rip rap at pipe outlets.

## 15.4.9 Pavement

The Pavement Design from the Materials and Tests Unit will specify either asphalt concrete plant mix pavement or Portland cement concrete pavement in the pavement design. Asphalt concrete plant mix pavements shall be paid for in accordance with [Section 610](#) of the NCDOT Standard Specifications for Roads and Structures. Concrete pavement shall be paid for in accordance with [Section 710](#) of the NCDOT Standard Specifications for Roads and Structures.

Refer to RDM Part II Chapter 13 Section 13.5 and the latest [NCDOT Asphalt Quality Management System Manual](#) for additional information.

### 15.4.9.1 Aggregate Base Course

Aggregate Base Course (ABC) may be recommended as an alternative to asphalt concrete base course in the Pavement Design submittal. Use the ABC Calculation of Quantities Sheet when estimating quantities for ABC. When all ABC calculations are complete and totaled, use the following procedure in the computation of final ABC quantity. Aggregate base course shall be paid for in accordance with [Section 520](#) of the NCDOT Standard Specifications for Roads and Structures.

- The quantity of ABC ranges from 0 to 1,000 tons – add 10 percent
- The quantity of ABC ranges from 1,001 to 5,000 tons – add 5 percent
- The quantity of ABC is equal to or greater than 5,001 tons – round off to next 100 tons

### 15.4.9.2 Prime Coat

[Section 600](#) of the NCDOT Standard Specifications for Roads and Structures states that prime coat is not required unless called for on the plans and in the estimate. Show all areas to be primed on the typical sections and pavement schedule. The Pavement Design from the Materials and Tests Unit will denote areas that will require prime coat. For prime coat not listed in the pavement design, use the following guidance to determine where to include prime coat:

1. On mainline or -Y- line paving areas when requested by Division Engineer, if approved by the Pavement Management Unit.
2. On any paving project (including detours and paved shoulders) when the bituminous concrete thickness is less than 2 inches.
3. In conjunction with 10-foot paved shoulders; if the remainder of the shoulder is all ABC, prime this area at a rate of 0.5 gallons per SY.



### 15.4.9.3 Milling

Asphalt milling refers to the grinding and removal of the topmost layer of asphalt pavement. Asphalt milling may be recommended in the Pavement Design or be needed to facilitate the tie of the resurfacing layer to the existing pavement or curb and gutter. Milling Asphalt Pavement shall be paid for in accordance with [Section 607](#) of the NCDOT Standard Specifications for Roads and Structures. There are three standard milling pay items:

1. Milling Asphalt Pavement, \_" to \_" – Sometimes referred to as profile milling, typically used on curb and gutter facilities to mill the lane adjacent to the curb and gutter to allow the resurfacing layer to tie flush with the curb and gutter
2. Milling Asphalt Pavement, \_" Depth – Typically used to mill the topmost layer of the asphalt pavement prior to resurfacing
3. Incidental Milling – Typically used to mill butt joints when tying the resurfacing layer flush with the existing pavement at the beginning and end of the project limits, for irregular areas, and for intersections milled as a separate operation from the mainline milling

### 15.4.10 Structures

Generally, all structure (bridges, culverts, and wall) pay items are the responsibility of the structure designer with the following exceptions when preparing plans and estimates for the final PS&E package (4RD1). Refer to [NCDOT Conceptual Construction Estimation Guidelines](#) for developing quantities for the conceptual construction estimate.

#### 15.4.10.1 Retaining Walls

Retaining walls are typically designed by the Geotechnical Engineering Unit in coordination with the structure designer and incorporated into the structure plan set. If there are no structure plans (bridges, culverts, etc.), the retaining wall plans will be incorporated into the roadway plan set as W-Series sheets and placed after the cross sections in accordance with RDM Part II Chapter 13 Section 13.3. The roadway designer will only be responsible for including the retaining wall quantities into the roadway estimate and referencing the wall plans in the index of sheets on sheet 1A. If there are structure plans the Structure Management Unit will be responsible for incorporating the retaining wall(s) into the structure plans and estimate. Refer to RDM Part I Chapter 5 Section 5.5 for additional guidance on retaining walls.

#### 15.4.10.2 Sound/Noise Barrier Walls

Sound and Noise Barrier Walls will typically be included in the structure plans, except when the noise barrier wall(s) is the only structure on the project. If there are no structure plans the roadway designer will be responsible for incorporating any noise barrier wall plans/envelopes and including the wall quantities into the roadway estimate. The noise barrier wall is paid for as a "Generic Retaining Wall" pay item. Refer to RDM Part I Chapter 5 Section 5.6 for additional guidance on sound barrier walls. Coordinate with the Traffic Noise & Air Quality Group.

### 15.4.11 Roadside Environmental

The roadway designer shall combine the Permanent Soil Reinforcement Mat (PSRM) quantity specified by the hydraulics engineer for ditch liner and toe protection applications with the PSRM quantities for specialized applications. This combined quantity should be provided to the Roadside Environmental Unit.

## 15.5 Cost-Based Estimate

When preparing the final construction estimate, projects with paving quantities (asphalt and ABC only) submit a completed NCDOT Cost-Based Quantity Estimate, which can be downloaded from the [NCDOT Contracts Resources](#) website under the Additional Resources section. Provide cost-based quantity estimates for all projects when submitting the Final Contract Package (4RD1). The Cost Based Quantity Estimate form is used by the estimating engineers in the Contract Standards and Development Unit to accurately price the asphalt and ABC quantities.

## 15.6 AASHTOWare Project and the Pay Items and Quantities Tool

[Refer to RDM Part II Chapter 13 Section 13.11.3.11 for guidance on AASHTOWare Project and the PIQ Tool.](#)

~~AASHTOWare Project (AWP) and the Pay Items and Quantities Tool (PIQ Tool) have replaced Trns\*port (PES/LES) and the Stand-Alone Project Worksheet (SAPW) for entering pay items and quantities for all centrally let and Division let projects. The roadway designer is responsible for entering all roadway pay items and quantities while also ensuring all required supplemental information is correctly entered.~~

~~The PIQ Tool is located in the preconstruction project sites in SharePoint and was designed to provide roadway designers with an easy-to-use tool to enter contract line items and quantities. The PIQ Tool is intended to be used by the Department's consultant partners for entering final pay items and quantities. NCDOT users should enter pay items by accessing AWP directly.~~

### ~~15.6.1 Pay Items & Quantities Quick Reference Guide and Training~~

~~Refer to the NCDOT Pay Items and Quantities Tool Document for links to the latest AWP and PIQ Tool documentation and training materials. A quick reference guide and training videos have been developed to introduce the designers and project managers to the tools. The quick reference guide outlines the purpose of the PIQ Tool and provides a summary of the responsibilities of the project managers, designers, and letting administrators. Additional guidance related to disciplines, pay item categories, and adding pay items is also provided. The roadway designer is responsible for all pay items entered under the roadway discipline.~~

This page intentionally left blank.

# Chapter 16 Roadway Lighting and Electrical

## 16.1 Introduction

The primary purpose of this chapter is to provide a comprehensive source of information pertaining to the development of roadway lighting plans for the North Carolina Department of Transportation (NCDOT or Department). The material presented in this chapter provides the user with a synopsis of the highway lighting design process, establishes uniform procedures and standards for designing new roadway lighting systems located within the Department's right of way and presents the Department's criteria, policies, and procedures on these issues.

The illumination requirements are based on recommendations found in the AASHTO *Roadway Lighting Design Guide*, as modified in this chapter, and follow the industry consensus of providing maximum illumination benefits at reasonable costs.

### 16.1.1 Lighting Overview

The primary purpose of roadway lighting is to provide improved safety, security, and aesthetics for the various users of the roadway and associated facilities. Roadway lighting assists drivers in recognizing the geometry and conflict points of the roadway at extended distances, thereby simplifying the driving task at night. This increases driver visual comfort and reduces driver fatigue, which helps contribute to highway safety.

### 16.1.2 References

Refer to Section 16.10 below for a list of reference manuals applicable to NCDOT lighting designs.

## 16.2 Lighting Policy

The [NCDOT Roadway Lighting Policy](#) is maintained by the Lighting and Electrical Team in the Roadway Design Unit. The NCDOT Roadway Lighting Policy describes the responsibilities and procedures for evaluating projects for lighting warrants and justifications and describes an exception and appeals process.

### 16.2.1 Roadway Lighting Committee

The NCDOT Roadway Lighting Committee is composed of a diverse group of technical experts from the Roadway Lighting and Electrical Team, Roadway Design Unit, Technical Services, Field Support, Asset Management, Traffic Safety, and Planning and Programming. Federal oversight is performed by an FHWA liaison assigned to attend NCDOT Roadway Lighting Committee meetings. The Committee meets quarterly to discuss lighting evaluations performed by the Lighting and Electrical Team and makes a formal determination on including roadway lighting in projects.

## 16.3 Lighting Evaluations

Because it is not economically feasible to light all conflict points along the roadway, the Department has adopted the Total Design Process (TDP) described in [NCHRP Report 152 Warrants for Highway Lighting](#) to determine warrants (minimum conditions) for installation of fixed roadway lighting systems on parts of roadways including, but not limited to, continuous sections, interchanges and intersections.

The guidelines for establishing warrants consist of average daily traffic (ADT), geometric, operational, environmental and accident factors. The evaluation method favors roadway facilities that are high in warranting conditions which can be lighted most economically.

Due to confidential cost information required to determine justification, all lighting evaluations are performed in-house by the NCDOT Lighting and Electrical Team.

### 16.3.1 Full Control of Access Freeways and Interchanges

Lighting evaluations for interchanges and continuous freeway sections are performed in accordance with the TDP as described in [NCHRP Report 152 Warrants for Highway Lighting](#). The TDP is a method of determining the cost-effectiveness of installing roadway lighting by generating a Priority Index (PI) to determine if investing state funds is justified.

The PI is based on need (warrant), benefit (traffic volume), and annualized cost factors. The PI is a unitless number established by multiplying need and benefit factors and then dividing by the cost. The result is compared to an accepted threshold value, below which investing state funds for roadway lighting is not justified. If the PI is above the threshold, roadway lighting is justified, and funds may be allocated on a priority basis.

Where a short continuous section of freeway between two justified interchanges does not justify lighting based on the results of the lighting evaluation, lighting may be considered for that section to reduce lighting transitions for motorists. The NCDOT Roadway Lighting Committee makes the final determination on lighting of these sections.

Division Engineers may request lighting for interchanges or continuous freeway sections which are not justified by the lighting evaluation.

Refer to the Exceptions and Appeals sections of the [NCDOT Roadway Lighting Policy](#) for more information.

### 16.3.2 Partial, Limited and No Control of Access Roadways and Intersections

The NCDOT Lighting and Electrical Team does not currently evaluate limited, partial, or no control of access roadways and intersections. It is recommended that lighting these facility types be installed via the encroachment process.

Refer to the [NCDOT Utility Accommodations Manual](#) for information concerning lighting encroachment requirements.

## 16.4 Illumination Requirements

Recommended roadway lighting illuminance and luminance values are found in the AASHTO *Roadway Lighting Design Guide*. NCDOT uses this guide as the basis for lighting design requirements for freeways, interchanges, rest areas, weigh stations, bridges, and vehicular tunnels. Average illumination requirements have been modified from the AASHTO *Roadway Lighting Design Guide* as discussed in the following subsections.

Luminance is the light value emitted from a source point plus light that is reflected from a surface. Illuminance is the light value on a surface. Using the luminance method for lighting design requires an in-depth knowledge of the many reflective characteristics of the pavement. NCDOT uses the illuminance method for lighting designs.

### 16.4.1 Continuous Freeway Lighting

Average maintained illumination on travel lanes, including travel lanes on bridges, shall be 0.8 foot-candles with 4:1 average to minimum uniformity ratio. At no point shall the minimum value go below 0.2 foot-candles.

When an overpass bridge is 200 feet or wider, provide underpass lighting when continuous freeway lighting is provided. Provide a light level and uniformity ratio for the underpass equal to the adjacent roadway lighting.

### 16.4.2 Complete Interchange Lighting

The average maintained illumination on all travel lanes, including travel lanes on bridges, within an interchange, from ramp merging points with the mainline on both sides of the interchange to the ramp terminals with the crossroad, shall be 0.8 foot-candles with 4:1 average to minimum uniformity ratio. At no point shall the minimum value go below 0.2 foot-candles.

When an underpass is 200 feet or wider, provide underpass lighting where freeway or interchange lighting is provided. Underpass Lighting shall always be provided when movements for Single Point Urban Interchanges or Diverging Diamond Interchanges are under the structure. Provide a light level and uniformity ratio for the underpass equal to the adjacent roadway lighting.

### 16.4.3 Rest Areas

The average maintained illumination for the entry gore, interior roadways, and exit gore shall be 0.6 foot-candle, with a maximum 4:1 average to minimum uniformity ratio and a maximum 0.3:1 veiling luminance ratio.

The average maintained illumination for all parking areas shall be 1 foot-candle with a maximum 4:1 average to minimum uniformity ratio, and a maximum 0.3:1 veiling luminance ratio.

The average maintained illumination for picnic areas, sidewalks and other pedestrian areas inside the perimeter roadway and parking areas, shall be 1 foot-candle, with a maximum 4:1 average to minimum uniformity ratio, and a maximum 0.3:1 veiling luminance ratio. Give special attention to areas of sidewalk with steps. Place light standards near steps to provide maximum benefit to pedestrians traversing these areas at night.

The average maintained illumination for walking trails which lead pedestrians away from the outside perimeter of the parking area shall be 2 foot-candles with a maximum 3:1 average to minimum uniformity ratio.

### 16.4.4 Weigh Stations

The average maintained illumination for all ramps, bypass lanes, parking areas and weigh bridges shall be 1 foot-candle with a maximum 4:1 average to minimum uniformity ratio.

### 16.4.5 Vehicular Tunnels

Refer to AASHTO *Roadway Lighting Design Guide* Chapter 4.0 for vehicular tunnel lighting requirements.

### 16.4.6 Limited, Partial and No Control of Access Facilities

Design lighting for limited, partial, and no control of access facilities to meet illumination values shown in the R3 pavement type column of the Illuminance and Luminance Design Value table in the AASHTO *Roadway Lighting Design Guide*.

### 16.4.7 Roundabouts

Lighting may be included at roundabouts on a case-by-case basis as determined by the Department. Where roundabout lighting is to be included, provide transition lighting along each approach leg, and extend lighting for a minimum of 400 feet from the center of the roundabout.

Design lighting for roundabouts with no lighting on any approach leg beyond the transition lighting at a value 1.3 times the value of the highest light level on any approach leg based on the classification.

Design lighting for roundabouts with approach lighting beyond the transition lighting at a value 2 times the value of the highest light level on any approach leg based on the classification.

Ensure the average to minimum uniformity ratio for all roundabouts is 3:1 or better.

For roundabouts with pedestrian crossings, place lighting so pedestrians are illuminated with positive contrast. Place light poles at a distance of approximately one-half pole height in front of the crosswalk from the driver's perspective.

### 16.4.8 Pedestrian Underpasses, Culverts and Tunnels

Provide adequate lighting for all pedestrian underpasses, culverts, and tunnels. A well-designed lighting system in these facilities aids users in facial recognition and eliminates dark areas, thereby increasing comfort level, safety, and security of pedestrians using the tunnel.

Design daytime lighting of pedestrian underpasses, culverts, and tunnels at a minimum average of 10 foot-candles with a maximum 3:1 average to minimum uniformity ratio.

Design nighttime lighting of pedestrian underpasses, culverts, and tunnels at a minimum average of 4 foot-candles with a maximum 3:1 average to minimum uniformity ratio.

## 16.5 Design Criteria

Design lighting to meet the illumination requirements of the AASHTO *Roadway Lighting Design Guide* (as discussed in Section 16.4 above), and the electrical requirements of the *NFPA 70 National Electrical Code* (NEC), and local codes. Use the illumination design values shown in the AASHTO *Roadway Lighting Design Guide* for the lighting design in areas not specifically addressed in Section 16.4. Refer to Section 16.10 below for luminaire specifications.

Provide full interchange lighting for interchanges approved for lighting. Approval from the lighting committee is required for partial lighting, which only provides lighting at decision points and is typically not used.

Lighting designs for interchanges and continuous freeway sections require either light standards (single and/or twin arm) with LED luminaires (traditionally referred to as cobrahead luminaires) or high mast standards with high mast LED luminaires, or a combination of light standards and high mast standards.

Typical mounting height for light standards is 45 feet, unless special circumstances exist which require alternative mounting heights. Include an FHWA approved impact attenuation (breakaway) device for light standards installed in the grassy shoulder or grassy median. Light



standards mounted on median barrier or bridge barrier rail do not require impact attenuation devices.

Typical mounting heights for high mast standards are 60 feet, 80 feet, 100 feet, and 120 feet.

### 16.5.1 Lighting Layout Guidelines

Design the lighting system so lighting can be contained on five circuits or less, leaving one circuit as a spare for future expansion, when possible. Consider the load current for each circuit so that circuits meet the limits presented in Section 16.5.2 below.

Place high mast standards near the intersections of the mainline ramps and the crossroad, with a single high mast standard placed diagonally on each side of the crossroad at the ramp terminal intersections. Place high mast standards between the ramps and the mainline or in the median where setback distance can be met. Maximize the use of high mast poles in the design to reduce use of single and twin arm poles.

Use single arm and twin arm light standards to illuminate areas where lighting from high mast poles cannot adequately reach. Place single arm light standards along the outside shoulder where the ramps merge with the mainline. Place twin arm light standards in a grassy median or on median barrier.

Select combinations of light standards and high mast standards which provide the best lighting design while maintaining the average illumination requirements of Section 16.4 above. Maximize the use of high mast standards to the greatest extent possible to reduce the number of roadside obstacles. Minimize light trespasses outside of the right of way to lessen the impact on residential areas close to interchanges.

Refer to Section 16.5.3 below, for additional pole placement guidelines.

Underpass lighting may be required where interchange or freeway lighting is included. Refer to Section 16.4.8 above for underpass lighting requirements. Where underpass lighting is required, wall mount (Type WM) luminaires mounted on the mechanically stabilized earth wall coping or end bent caps are preferred. When the road intersecting the mainline runs under the mainline, pendant mount (Type PM) luminaires hung from the bridge deck can be used when underpass lighting is required. Because Type PM luminaires require the closure of travel lanes to perform maintenance activities, only use Type PM when Type WM luminaires cannot adequately light under the bridge or when movements for Single Point Urban Interchanges and Diverging Diamond Interchanges occur under the bridge.

### 16.5.2 Voltage Drop Requirements

NEC Articles 210-19(A) (Informational Note No. 3) and 215-2(A)(1)(b) (Informational Note No. 2), recommend no more than 5 percent combined voltage drop for feeder and branch circuits. Size conductors for lighting circuits to limit the voltage drop from the lighting control panel to the end of any branch circuit to no greater than 3 percent.

### 16.5.3 Equipment Locations

Locate light standards and high mast standards in areas which provide adequate clearances from utility lines, railroads, and airport glide slope paths. Coordinate lighting design with other utility features. Lighting installations near airfields may require written approval from the Federal Aviation Authority (FAA). Refer to Section 16.9.1 below, for additional information.



The minimum pole setback distances are:

- 15 feet from the edge-of-travel for shoulder mounted light standards
- 50 feet from the edge-of-travel for high mast standards
- 6 feet behind the face of guardrail for both light standards and high masts
- 12 feet from cable guiderail for both light standards and high masts

Install twin arm light standards in a grassy median where the median width is greater than 30 feet or the twin arm standards are protected by guardrail on both sides. Install twin arm light standards on median barrier when barrier is present. Twin arm light standards installed on a barrier are preferred over single arm light standards installed on the shoulder.

Do not locate high mast standards or light standards in the following areas:

- any ditch lines
- retention ponds or other areas of low-lying ground
- inside overhead power utility easements
- in railroad right of way

Placement of high mast standards is typically limited to interchange gore areas. Do not locate high mast standards to the outside of interchange loops, particularly at the location where the loop separates from the high-speed mainline, to the outside shoulder of interchange ramps, or to the outside shoulder of continuous sections of freeway between interchanges. Due to the need for guardrail protection and potential conflict with future widening, installation of high mast standards in the median is discouraged. Exhaust all other methods of providing adequate, cost-effective lighting prior to installing high mast standards in the median.

Locate the lighting control system panel near access to electrical service, inside the control access fence, with easy access and in a central location for all circuit runs. When a meter is mounted on a service pole, mount the pole in an area easily accessible from the road. Mount the service pole no more than 10 feet from the control of access fence as shown in [NCDOT Roadway Standard Drawings](#) Std. No. 1407.01. If a meter is not mounted on a service pole, as shown in [NCDOT Roadway Standard Drawings](#) Std. No. 1408.01, Sheet 2, ensure the meter enclosure is easily accessible and not located within 3 feet of an obstruction.

For lighting designs prepared by private engineering firms, submit preliminary lighting plans showing pole and equipment locations to the NCDOT Lighting and Electrical Team Lead prior to proceeding with design.

#### 16.5.4 Photometric Designs

A photometric analysis of the project is required to determine the correct pole type and layout. Use photometric analysis software to calculate the light level and uniformity ratio on all roadway surfaces. The photometric analysis should delineate the coverage area to separate segments of the roadway travel lanes such as the mainline, intersecting road, roundabouts, and bridge underpasses. Refer to Section 16.4 above for illumination requirements.

For lighting designs prepared by private engineering firms, submit photometric layouts with the preliminary lighting plans.

### 16.5.5 Limited, Partial and No Control of Access Facilities

Generally, the Department does not install, own, or maintain lighting on limited, partial, and no control of access NCDOT maintained roadways per the [NCDOT Roadway Lighting Policy](#). Exceptions may be made on a case-by-case request.

Municipalities desiring street lighting for existing NCDOT maintained roadways must submit an Encroachment Agreement request to the District Engineer's office through the [NCDOT Encroachment Agreements](#) website.

Refer to the [NCDOT Utility Accommodations Manual](#) for lighting encroachment requirements.

Municipalities desiring installation of street lighting as part of an NCDOT TIP project are required to enter into a municipal agreement documenting the ownership and maintenance of the lighting system after project completion. In most cases the Municipality will be required to reimburse the Department for lighting installed as part of the TIP project and must agree to own, maintain, and pay all utility bills associated with the installed lighting. Municipal Agreements may be coordinated with the Project Manager.

## 16.6 Design-Build Guidelines

Design-Build projects present unique challenges not experienced on conventional design-bid-build projects. To keep costs down and maintain design consistency, the Lighting and Electrical Team generally provides preliminary and final lighting plans for Design-Build projects.

### 16.6.1 Scope of Work and Preliminary Lighting Plans

A Lighting Scope of Work is required for all Design-Build projects. The Lighting Scope of Work is included in the request for proposal and describes the Department's requirements for the Design-Build Team as part of the project, including whether the Department or the Design-Build Team is responsible for the lighting design.

For Design-Build projects where NCDOT personnel are responsible for the lighting design, a preliminary lighting design is prepared based on the preliminary roadway plans available at the time of the advertisement. The preliminary lighting design is prepared to a roughly 90 percent state where all equipment is known and the locations are identified; however, stationing is not required at the preliminary stage. The preliminary lighting plans are included with the Design-Build request for proposals. The preliminary lighting design is updated after the final release for construction roadway plans are accepted by the Department. Refer to Section 16.6.2 below for information regarding final lighting plans.

For Design-Build projects where the Design-Build Team is responsible for the lighting design, the team must submit plans showing proposed lighting equipment locations along with a photometric design to the NCDOT Lighting and Electrical Team prior to proceeding with the final lighting design. Maximize the use of high mast poles for interchange lighting designs. It is understood that high mast poles have a higher up-front cost, but this is offset by the ease of maintenance and reduction in roadside obstacles. The NCDOT Lighting and Electrical Team will review the equipment locations for construction or maintenance conflicts. Upon NCDOT approval of the equipment locations, the Design-Build Team may proceed with the final lighting design.

## 16.6.2 Final Lighting Plans

For Design-Build projects where NCDOT personnel are responsible for the lighting design, upon acceptance of the Design-Build Team's release for construction roadway design plans, the Lighting and Electrical Team prepares the final lighting design plans. Due to the compressed schedules prominent in most Design-Build projects, there is minimal time available to complete the final lighting plans; generally, 10 to 20 business days. Final sealed lighting plans are provided to the Design-Build Engineer who is responsible for distributing the sealed lighting plans to the Design-Build Team.

For Design-Build projects where the Design-Build Team is responsible for the lighting design, the team must prepare and submit final lighting plans based on the equipment locations shown in Section 16.6.1 above. At a minimum, submit 100 percent plans prior to release for construction plan submittal to allow the Department to comment on the design. Include equipment layout with location, circuitry and duct layout, voltage drop calculations, and photometric calculations with the 100 percent plans. Additional pre-release for construction lighting plan submittals is encouraged during the development of the lighting plans.

## 16.7 Power Supply

Consider the available power supply when designing lighting plans. The voltage supplied to lighting control systems for roadway lighting is typically 240/480V, 3 Wire, Single Phase. Alternate service voltages and phases can be utilized on a case-by-case basis.

The voltage supplied for rest area, visitor center, or weigh station lighting is typically 120/208V, 4 Wire, 3 Phase.

In the lighting design file, place a control panel with a service pole, when required, near overhead power lines (if available), ideally near the top of a ramp of an interchange.

Refer to [NCDOT Standard Specifications for Roads and Structures](#) Section 1400-9 for instruction on how to establish electrical service during construction.

A control panel is used to provide power to the luminaires from a central location. Label control panels as "Suitable for Use as Service Equipment" per Standard Specification 1408-02. Include a load schedule table in the lighting plans on the same sheet as the control panel(s). Include location, voltage required, circuit identification, quantity of luminaires, current, KW load, and breaker size in amps on the load schedule. Refer to Section 16.5.3 above for recommended control panel locations.

## 16.8 Bid Items and Estimates

Lighting bid items are located in Section 1400 of the most recent version of the [NCDOT Master Pay Item List](#). Not all items in the Master Pay Item List are required on each project. Pay items with SP in the section column require a Special Provision. Special Provisions are supplied with the project plans and estimate. Refer to Section 16.10 below for additional information on Special Provisions.

Preliminary and final estimates are required for each lighting design. Preliminary estimates are calculated and provided to the Estimating Management Section as part of the lighting evaluation process. Refer to Section 16.3 above for information on lighting evaluations. Final estimates are prepared and provided to the Estimating Management Section after the lighting design is complete.

### 16.8.1 Design-Bid-Build Projects

Upon completion of the final lighting plans for Centrally let and Division let Design-Bid-Build projects, a complete list of lighting bid items is assembled and uploaded.

For in-house lighting designs, the bid items are uploaded by the Lighting and Electrical Team into AASHTOWare Project (AWP).

For lighting designs prepared by private engineering firms, the firm is required to upload the lighting bid items using the Pay Items and Quantities (PIQ) Tool.

Refer to RDM Part II Chapter 15 Section 15.6 for additional information concerning the PIQ Tool. Notify the Lighting and Electrical Team Lead after all lighting items are uploaded by the private engineering firm using the PIQ Tool.

After bid items have been uploaded to AASHTOWare Project or PIQ, the NCDOT Lighting and Electrical Team generates a Quantity Estimate Report for lighting items. Bid item estimated prices are manually written on the Quantity Estimate Report and the report with pricing is provided to the Engineer's Estimate Squad Leader in the Estimating Management Section.

In addition, a final lump sum lighting estimate based on the sealed contract plans is emailed to the Preliminary Estimating Squad Leader.

### 16.8.2 Design-Build Projects

The NCDOT Lighting and Electrical Team is responsible for lighting estimates on Design-Build projects. Design-Build lighting estimates are lump sum and pay item lists are not provided. Design-Build estimates are sent to the State Estimating Engineer in a sealed envelope marked Confidential.

For Design-Build projects where the lighting plans are prepared in-house by the NCDOT Lighting and Electrical Team, the lump sum lighting estimate is based on the preliminary plans included in the Design-Build request for proposals and includes construction cost only.

For Design-Build projects where the lighting plans are prepared by the Design-Build Team, the lump sum lighting estimate includes the preliminary costs shown in the Lighting Evaluation (refer to Section 16.3 above) and a man-hour estimate for creation and completion of the lighting plans.

## 16.9 Special Considerations

### 16.9.1 Coordination with the Federal Aviation Authority

Where a lighting design is located within 5 miles of an airport runway, perform calculations to determine if any lighting system component penetrates any runway approach or other imaginary surface.

Refer to [FAA Form 7460-1, Notice of Proposed Construction or Alteration](#) Section 77.9 for calculation requirements.

Submit any pole determined to penetrate an imaginary surface as outlined in Form 7460-1 to the FAA for review and determination. The FAA will review and respond to the submission via email. A determination will be made within 45 days. The FAA may require modification of the pole heights to reduce hazards to navigable airspace.

Refer to NCDOT document [FAA Coordination](#) for additional information.

## 16.9.2 Wildlife Sensitive Areas

When roadway lighting is included in areas with light sensitive flora and fauna, the lighting design may have to be reviewed and approved by staff in the Environmental Analysis Unit (EAU) and the United States Fish and Wildlife Service. Make every effort to address comments and concerns from the EAU or United States Fish and Wildlife Service staff.

Listed bat species have been found to have a habitat in the counties shown in Table 16-1. When performing lighting evaluations in these counties, copy an Environmental Program Consultant within the EAU on the evaluation. Bring any biological concerns from the EAU to the attention of the State Roadway Design Engineer and the NCDOT Roadway Lighting Committee.

**Table 16-1 Counties with Listed Bat Species**

Alexander	Carteret	Gaston	Martin	Surry
Alleghany	Catawba	Gates	McDowell	Swain
Ashe	Cherokee	Graham	Mecklenburg	Transylvania
Avery	Clay	Haywood	Mitchell	Tyrrell
Beaufort	Cleveland	Henderson	New Hanover	Washington
Bertie	Columbus	Hyde	Pasquotank	Watauga
Bladen	Craven	Iredell	Pender	Wilkes
Buncombe	Currituck	Jackson	Polk	Yadkin
Burke	Dare	Jones	Rowan	Yancey
Cabarrus	Davidson	Lincoln	Rutherford	
Caldwell	Davie	Macon	Stanly	
Camden	Forsyth	Madison	Stokes	

## 16.10 Specifications

NCDOT has standard specifications and provisions for lighting system components installed as part of lighting projects.

Refer to [NCDOT Standard Specifications for Roads and Structures Division 14](#) and [NCDOT Roadway Standard Drawings](#) Std. Nos. 1401.01 through 1412.01 for lighting standard drawings.

Typically, each lighting project has unique features or items not covered in the standard specifications and drawings. Include lighting design items not covered in the standard specifications as a Special Provision.

### 16.10.1 Standard Specifications

Refer to [NCDOT Standard Specifications for Roads and Structures Division 14](#) for information required to furnish, install, and bring into service roadway lighting at designated locations. Division 14 consists of several sections. Each section covers information and details pertaining to a specific roadway lighting topic.

Refer to [NCDOT Roadway Standard Drawings](#) for detailed drawings of components required for lighting installations such as high mast standards, light standards, control system panels, and underpass lighting. Use the NCDOT Roadway Standard Drawings in conjunction with the NCDOT Standard Specifications for Roads and Structures.

### 16.10.2 Standard Provisions

The Department maintains a list of [NCDOT Standard Provisions](#) for pay items that require frequent updates. Project specific Standard Provisions are inserted by the Contracts Standards and Development Unit when specific pay items are included in a contract. Two examples related to lighting pay items are the Standard Provisions titled Foundations and Anchor Rod Assemblies for Metal Poles and Roadway Lighting Foundations. Both Standard Provisions are maintained by the Geotechnical Engineering Unit.

### 16.10.3 Project Special Provisions

Lighting Project Special Provisions cover items and tasks that are part of the lighting project but not addressed in Section 1400 of the [NCDOT Standard Specifications for Roads and Structures](#) and [NCDOT Roadway Standard Drawings](#) or included as a Standard Provision.

Each Special Provision typically consists of four categories: Description, Material, Construction Methods and Payment.

Refer to the [NCDOT Provision Writers' Guide](#) for format, style, and specific information to include in Special Provisions.

### 16.10.4 Additional Resources

Refer to the following resources along with the RDM when designing roadway lighting and electrical systems. Editions and years mentioned below are current as of the date of publication of this manual.

**Table 16-2 Additional Resources**

Resource Title	Edition	Year	Organization
<a href="#">NCDOT 2018 Specifications and Special Provisions</a>		2018	NCDOT
<a href="#">NCDOT ITS and Signals Unit Manual Part 3 - ITS</a>		2004	NCDOT
<a href="#">NCDOT LED Luminaire Specifications</a>		2021	NCDOT
<a href="#">NCDOT LED Luminaire Special Provisions</a>		2021	NCDOT
<a href="#">NCDOT Provision Writers' Guide</a>		2012	NCDOT
<a href="#">NCDOT Roadway Lighting Policy</a>		2020	NCDOT
<a href="#">NCDOT Standard Roadway Drawings</a>		2018	NCDOT
<a href="#">NCDOT Standard Specifications for Roads and Structures</a>		2018	NCDOT
<a href="#">NCDOT Utilities Accommodation Manual</a>		2021	NCDOT
AASHTO Roadside Design Guide	4th	2011	AASHTO
AASHTO Roadway Lighting Design Guide	7th, GL-7	2018	AASHTO
AASHTO Standard Specifications for Structural Supports for Highway Signs, Luminaires and Traffic Signals	6th	2013	AASHTO
ANSI/IES Luminaire Classification System for Outdoor Luminaires	TM-15-20	2020	ANSI/IES
ANSI/IES Recommended Practice for Design and Maintenance of Roadway and Parking Facility Lighting	RP-8-18	2018	ANSI/IES
<a href="#">FHWA Lighting Handbook</a>		2012	FHWA
<a href="#">Code of Federal Regulations Title 14 Part 77.9</a>		2010	FAA

Resource Title	Edition	Year	Organization
National Electric Safety Code (NEC)		2017	IEEE
NFPA 70 NEC		2020	NFPA
<a href="#"><i>NCHRP Warrants for Highway Lighting</i></a>	Report 152	1974	NCHRP/TRB

This page intentionally left blank.



# Chapter 17 Design Exception Preparation Guidelines

## 17.1 Design Exception Process

It is the purpose of this document to assist the roadway designer in the preparation of the formal documentation needed to request a design exception. The design exception process is a procedure that documents the economic, physical, social, or environmental constraints that prevent the application of specific highway design criteria or standards.

## 17.2 Design Policy

It is the policy of NCDOT that the geometric design of all new highway construction, reconstruction, or improvements of state maintained roadways meet the guidance contained in the current edition of the GB, *AASHTO A Policy on Design Standards - Interstate System* or NCDOT Division of Highways [R-R-R Guidelines](#). The functional and context classifications of the roadway are factors when determining the design criteria.

These guidelines supersede the Department's previous Design Exception Preparation Guidelines (Rev. April 2004) and Design Exception Policy (Rev. January 1999).

## 17.3 Design Flexibility

The GB encourages design flexibility emphasizing the role of the roadway design team in determining appropriate design dimensions based on project-specific conditions and existing and future roadway performance over meeting specific nominal design criteria. The GB defines project types as follows:

- **New construction:** Projects that construct a roadway on new alignment where no existing roadway is present.
- **Reconstruction:** Projects that utilize an existing roadway alignment (or make only minor changes to an existing alignment) but involve a change in the basic roadway type. Changes in the roadway type include adding through lanes, adding a raised or depressed median where none currently exists, and where these changes cannot be accomplished within the existing roadway footprint (including shoulders).
- **Projects on existing roads:** Construction projects on existing roads are those that keep the existing roadway alignment (except for minor changes) and do not change the basic roadway type.

New construction projects typically use the design criteria presented in the GB because there are often fewer constraints when constructing projects on new alignment. As stated in the GB, "Reconstruction projects often create the most difficult design decisions because a new facility type is being adapted to an existing alignment and needs to fit within the existing community context."<sup>1</sup>

The GB notes the design for projects on existing roadways are typically intended to address identified performance issues rather than improving geometric features for the sole purpose of meeting AASHTO design criteria. Geometric changes are needed for projects along existing

---

<sup>1</sup> GB, Chapter 1, Section 1.7.2.

roads when the forecasted performance indicates such a need. The GB further notes when an existing road is performing well and anticipated to continue to perform well, improving geometric features simply for improvement's sake is a potential waste of the limited funds available for transportation improvements that could be better spent addressing identified problems on other roads.

Exercising design flexibility may result in leaving well-performing design elements remaining unchanged even if they do not fully meet the design criteria normally used in new construction. Leaving existing design elements unchanged may result in the need for a design exception.

## 17.4 Need for a Design Exception

For projects on existing roadways, reconstruction projects, and new construction projects a design exception is needed when:

- The proposed design does not meet the minimum GB value for the design speed of the roadway's functional classification.

The design speed should be the greater of the minimum design speed for the facility type or the anticipated posted speed plus 5 mph. An element may not require a design exception if the element meets the posted speed limit. Coordinate with the roadway design team lead or Division designee to confirm how best to proceed.

Design exceptions primarily focus on the mainline alignment (-L-). However, design exceptions may also be warranted on -Y- lines if they are Interstate, US, NC routes, or state-maintained roads that involve a significant amount of construction or reconstruction. Coordinate with the Roadway Design Unit Group Lead or Division designee to determine the appropriate method for the documentations of this design decision.

The need for a design exception is determined by comparing the project's proposed controlling criteria with the minimum and maximum values the GB specifies for the design speed based on the roadway's functional and context classifications. A design exception is required when it is determined that one or more of the controlling criteria for the proposed design cannot meet the minimum or maximum values specified in the GB for the design speed. A design exception may not be needed if an element meets the posted speed. Coordinate with the Roadway Design Unit Group Lead or Division designee to confirm the method for documentation of this design decision.

Design exceptions are not required on preventative maintenance projects due to the nature of the maintenance activities. Preventative maintenance projects do not change the alignment, geometric features, or capacity of the roadway. Preventative maintenance work includes roadway activities such as joint repair, pavement patching, resurfacing (1½ inches or less in thickness), shoulder repair, restoration of drainage systems, bridge painting, pavement markings, and other maintenance type activities.

### 17.4.1 Design Exception Definition

The [\*FHWA Mitigation Strategies for Design Exceptions \(July 2007\)\*](#) is archived on the FHWA website because some of the information is out of date. However, this document provides a good discussion on reasons for considering design exceptions that remain applicable in their preparation. This formal documentation is important because it outlines the reasons why the design exception is appropriate based on considerations such as the project's stated purpose and need, how the requirements of the various transportation modes are met, existing project

context, environmental considerations, past performance, how it is expected to perform in the future, and project budget and cost.

The decision to request a design exception should not be made in an arbitrary manner and should be carefully considered before implementation. The design exception should not be viewed as lessening the project's purpose or allowing an unsafe situation to exist. The design exception preparation guidelines provide for appropriate reviews and documentation steps to ensure the design exception will continue to achieve a future level of performance that will meet the project's purpose and the transportation needs of its users.

#### 17.4.2 Design Exception Approval Authority

As part of the [FHWA-NCDOT Stewardship Agreement](#), NCDOT has assumed the responsibility of approving design exceptions for Federal-Aid Highway program (FAHP) projects on all National Highway System (NHS) routes including interstates. In addition, NCDOT evaluates and approves design exceptions for projects that are not on NHS routes, even though FHWA has no design exception requirements for FAHP projects off the NHS. For simplicity, NCDOT has chosen to follow the same design exception process for all state and federally funded projects whether they are on an NHS route or not.

For design exceptions on projects that are Division managed, the respective Division Engineer has the final approval authority. For projects that are centrally managed, the Director of Technical Services has the final approval authority.

#### 17.4.3 Design Exception Submittal Timeframe

Early identification and coordination regarding a design exception allows time to consider the operational aspects of the project that may be affected. This also allows time to implement any revisions necessary as a result of the design exception coordination process. An early start also provides time for supplemental data to be obtained without adversely affecting the project delivery schedule. The design exception should be documented as soon as the need for the design exception is identified. The need could be recognized as early as the completion of the Express Design in PDN Stage 1 (Project Initiation) and noted in the Project Scoping Report. Begin discussing the need for formal design exception(s) with the Roadway Design Unit Group Lead or Division designee early in plan development. Submit the formal design exception request in PDN Stage 2 (Alignment Defined) once the designs for the Design Recommendation Plan Set is finalized.

For Design-Build projects, an approved design exception is required prior to the final RFP. This is typically 3 months after the Design Build advertisement.

#### 17.4.4 Revisions to Approved Design Exception.

One of the goals of Integrated Project Delivery (IPD) is for coordination efforts to take place between team members early and often to minimize efforts to continually reevaluate design decisions. However, if a design revision is required after the approval of a design exception and it changes the previously approved design exception, it must be documented. Coordinate with the Roadway Design Unit Group Lead or Division designee to determine the appropriate method of documentation.

#### 17.4.5 Retention of Design Exceptions

The completed approved design exceptions are an integral part of the project record and should be retained and placed on the project's Preconstruction Team Site on SharePoint. Coordinate

with the Roadway Design Unit Group Lead or Division designee to determine the appropriate location for the approved design exception. Identify the approved design exception as a RDY key document on the project's SharePoint team site.

## 17.5 Controlling Criteria for Design

For projects that have a design speed greater than or equal to 50 mph, request a design exception when one or more of the following ten specific controlling criteria do not meet the values specified in the GB.

1. Design Speed
2. Lane Width
3. Shoulder Width\*
4. Horizontal Curve Radius
5. Superelevation Rate
6. Stopping Sight Distance for horizontal curves and crest vertical curves
7. Maximum Grade
8. Cross Slope
9. Vertical Clearance
10. Design Loading Structural Capacity

\* Note: The paved shoulder is not one of the ten controlling criteria and does not require a design exception. The [NCDOT Interstate Controlling Criteria Tool](#) provides a comparison of the GB paved shoulder guidance for interstates and the NCDOT paved shoulder policy. Discuss paved shoulders that do not meet GB or the NCDOT Paved Shoulder Policy with the project team.

For projects that have a design speed less than 50 mph, request a design exception when one or more of the controlling criteria listed below do not meet the minimum values specified in the GB. However, document all ten controlling criteria on the Design Exception Process Checklist.

1. Design Speed
2. Design Loading Structural Capacity

The ten controlling criteria are described in the following sections.

### 17.5.1 Design Speed

The GB defines design speed as a selected speed used to determine the various geometric design features of the roadway. Five of the remaining nine controlling design criteria are related to the design speed.

Request a design speed exception when multiple design criteria do not meet specific values for a significant portion of the project length. Discuss the use of a design speed exception with the Roadway Design Unit Group Lead or Division designee.

### 17.5.2 Lane Width

Lane width is based on functional classification of the roadway, design speed, and design year traffic projections. Refer to RDM Part I Chapter 4 Section 4.3.

### 17.5.3 Shoulder Width

Shoulder width is based on functional classification of the roadway and design year traffic projections. Refer to RDM Part I Chapter 4 Section 4.4.1.

### 17.5.4 Horizontal Curve Radius

Refer to GB Chapter 3 Section 3.3.5 Tables 3-8 through 3-12 for the minimum radii required for various design superelevation rates.

### 17.5.5 Superelevation Rate

Refer to RDM Part I Chapter 3 Section 3.4 and GB Chapter 3 Section 3.3.5 Tables 3-8 through 3-12 for the maximum superelevation rate for the type of roadway being designed.

### 17.5.6 Stopping Sight Distance

Stopping sight distance (SSD) is dependent on the design speed, brake reaction time, braking distance, grades, and deceleration and applies to horizontal curves and crest vertical curves. The controlling values for horizontal SSD and vertical SSD will be the same. Refer to GB Chapter 3 Section 3.4.6.2 Table 3-35 for SSD and corresponding K values for crest vertical curves for given design speeds.

The proposed design value for horizontal SSD is obtained graphically from the plans as described in GB Chapter 3 Section 3.3.12.1 Figure 3-13.

Refer to RDM Part I Chapter 3 Section 3.2.2 for additional guidance regarding SSD.

### 17.5.7 Maximum Grade

Maximum grades are determined based on terrain type and design speed. Refer to GB Chapters 5 through 10 for tables that provide the maximum grades for the various facility types.

Refer to RDM Part I Chapter 3 Section 3.5.1 for additional references.

### 17.5.8 Cross Slope

Pavement cross slope is based on functional classification and roadway typical sections. Refer to GB Chapter 4 Section 4.2.2 for information on pavement cross slopes. NCDOT has adopted the value of .02 as the typical normal crown. Refer to RDM Part I Chapter 2 Section 2.7.4 for additional discussion on the rate of cross slope.

### 17.5.9 Vertical Clearance

Minimum vertical clearances are dependent upon facility type. Refer to RDM Part I Chapter 5 Section 5.3.4 for guidance pertaining to vertical clearances.

### 17.5.10 Design Loading Structural Capacity

The Structures Management Unit will verify the safe load-carrying capacity (load rating) for all state unrestricted legal loads or routine permit loads, and all federal legal loads for bridges and tunnels on Interstates and will advise if a design exception is needed.

## 17.6 Complete the Design Exception Process Checklist

When the proposed roadway design is established in PDN Stage 2, the Design Exception Process Checklist is completed. For short projects such as bridge replacement projects and projects with very little proposed work along -Y- lines, the checklist is usually completed for the mainline only since most of the work is along the mainline. For longer projects with significant -Y- line construction and interchange construction, the Design Exception Process Checklist should be completed for the mainline, -Y- lines, and interchange ramps and loops.

The controlling criteria for the proposed roadway design will be compared with the values for the controlling criteria provided on the checklist. Note the roadway design controlling criteria that do not meet the values on the checklist along with the design speed that is achieved. Note also if a design exception is required. The project's design criteria package and typical sections will serve as a tool when completing the Design Exception Process Checklist. For projects along interstate facilities or future interstate facilities, use the [NCDOT Interstate Controlling Criteria Tool](#) for identifying potential design exceptions for interstate facilities.

Download the design exception process checklists by accessing the "Email and Memo Templates" zip file in Helpful Links on the [NCDOT Project Management Connect Site](#).

## DESIGN EXCEPTION PROCESS CHECKLIST

Date: \_\_\_\_\_

Design Engineer: \_\_\_\_\_

TIP No: \_\_\_\_\_

Functional Classification: \_\_\_\_\_

Posted Speed: \_\_\_\_\_

Terrain: \_\_\_\_\_

**Note: For projects with a design speed of less than 50 mph, a design exception request will only be required for items A and B. However, all 10 controlling criteria shall be completed.**

**In the Exception Required column indicate Yes or No as to whether an exception is needed.**

<u>Controlling Criteria requiring review for Design Exception</u>	<u>Prop Design</u>	<u>AASHTO Std</u>	<u>Exception Required</u>
A) Design Speed <sup>1</sup>	_____	_____	_____
B) Structural Capacity <sup>2</sup>	_____	_____	_____
C) Lane Width	_____	_____	_____
D) Shoulder Width	_____	_____	_____
E) Maximum Grade	_____	_____	_____
F) Min. Horizontal Curve Radius	_____	_____	_____
G) Horizontal SSD	_____	_____	_____
H) Vertical SSD (Crest Only)	_____	_____	_____
I) Pavement Cross Slope	_____	_____	_____
J) Superelevation	_____	_____	_____
K) Vertical Clearance	_____	_____	_____

**Listed below are the known non-complying items not requiring an approved design exception.**

Notes:

- 1 The design speed should be the greater of the minimum design speed for the facility type or the anticipated posted speed plus 5 mph. An element may not require a design exception if the element meets the posted speed limit. Coordinate with the Roadway Design Unit Group Lead or Division designee to confirm that a design exception is not needed.
- 2 The Structures Management Unit will check the structural capacity (load rating). Coordinate with the appropriate Structures Management Unit engineer to determine if a design exception is needed.

## DESIGN EXCEPTION PROCESS CHECKLIST (For Subregional Tier)

Date: \_\_\_\_\_ Design Engineer: \_\_\_\_\_  
 TIP No: \_\_\_\_\_ Functional Classification: \_\_\_\_\_  
 Posted Speed: \_\_\_\_\_ Terrain: \_\_\_\_\_

**Note: For projects with a design speed of less than 50 mph, a design exception request will only be required for items A and B. However, all 10 controlling criteria shall be completed.**

**In the Exception Required column indicate Yes or No as to whether an exception is needed.**

<u>Controlling Criteria requiring review for Design Exception</u>	<u>Prop Design</u>	<u>AASHTO Std</u>	<u>Subregional Tier</u>	<u>Exception Required</u>
A) Design Speed <sup>1</sup>	_____	_____	_____	_____
B) Structural Capacity <sup>2</sup>	_____	_____	_____	_____
C) Lane Width	_____	_____	_____	_____
D) Shoulder Width	_____	_____	_____	_____
E) Maximum Grade	_____	_____	_____	_____
F) Min. Horizontal Curve Radius	_____	_____	_____	_____
G) Horizontal SSD	_____	_____	_____	_____
H) Vertical SSD (Crest Only)	_____	_____	_____	_____
I) Pavement Cross Slope	_____	_____	_____	_____
J) Superelevation	_____	_____	_____	_____
K) Vertical Clearance	_____	_____	_____	_____

**Listed below are the known non-complying items not requiring an approved design exception.**

Notes:

- The design speed should be the greater of the minimum design speed for the facility type or the anticipated posted speed plus 5 mph. An element may not require a design exception if the element meets the posted speed limit. Coordinate with the Roadway Design Unit Group Lead or Division designee to confirm that a design exception is not needed.
- The Structures Management Unit will check the structural capacity (load rating). Coordinate with the appropriate Structures Management Unit engineer to determine if a design exception is needed.



## DESIGN EXCEPTION PROCESS CHECKLIST (For Design Speed Exceptions)

Date: \_\_\_\_\_ Design Engineer: \_\_\_\_\_  
 TIP No: \_\_\_\_\_ Functional Classification: \_\_\_\_\_  
 Posted Speed: \_\_\_\_\_ Terrain: \_\_\_\_\_

**Note: For projects with a design speed of less than 50 mph, a design exception request will only be required for items A and B. However, all 10 controlling criteria shall be completed.**

**In the Exception Required column indicate Yes or No as to whether an exception is needed.**

<u>Controlling criteria requiring review for Design Exception</u>	<u>Prop Design</u>	<u>AASHTO Std</u>	<u>AASHTO Std</u>	<u>Exception Required</u> (__mph/__mph)
A) Design Speed <sup>1</sup>	_____	_____	_____	_____
B) Structural Capacity <sup>2</sup>	_____	_____	_____	_____
C) Lane Width	_____	_____	_____	_____
D) Shoulder Width	_____	_____	_____	_____
E) Maximum Grade	_____	_____	_____	_____
F) Min. Horizontal Curve Radius	_____	_____	_____	_____
G) Horizontal SSD	_____	_____	_____	_____
H) Vertical SSD (Crest Only)	_____	_____	_____	_____
I) Pavement Cross Slope	_____	_____	_____	_____
J) Superelevation	_____	_____	_____	_____
K) Vertical Clearance	_____	_____	_____	_____

**Listed below are the known non-complying items not requiring an approved design exception.**

Notes:

- 1 The design speed should be the greater of the minimum design speed for the facility type or the anticipated posted speed plus 5 mph. An element may not require a design exception if the element meets the posted speed limit. Coordinate with the Roadway Design Unit Group Lead or Division designee to confirm that a design exception is not needed.
- 2 The Structures Management Unit will check the structural capacity (load rating). Coordinate with the appropriate Structures Management Unit engineer to determine if a design exception is needed.

## 17.7 Complete the Design Exception Request Form

Complete the Design Exception Request form at the end of this section after determining the need for an exception. The request form should be completed for all controlling criteria identified on the Design Exception Checklist that do not meet the GB values. Refer to the information in the following subsections for assistance in completing the form. The request form has been developed to ensure consistent and sufficient documentation is provided for design exceptions.

Download the design exception request form by accessing the “Email and Memo Templates” zip file in Helpful Links on the [NCDOT Project Management Connect Site](#).

### 17.7.1 Heading Section

The heading section provides descriptive project information and identifies the location of the controlling criteria that require an exception.

- Provide the FA and the State Project Numbers, the TIP Number, and the County where the project is located.
- Provide the controlling elements that require an exception.
- Provide the location of the design feature(s) that requires an exception. List the criteria that require an exception by alignment designation and stationing (i.e. -L- station 10+00 or -L- station 10+00 to 13+50).

For a design speed exception on short projects such as bridge replacement projects, list the entire project limits as the location. For a design speed exception on longer projects, provide the length of the portion of the project with reduced design speed as it relates to the length of the entire project. If the only location that requires a design exception is where the project ties to the existing roadway, then a design exception is not needed. Document this finding in a memo to the project file. If there are other locations where design exceptions are needed along the project, and the project tie-in location does not meet the GB values, then the documentation regarding the project tie-in can be added within the design exception and no separate memo is needed in the project file.

### 17.7.2 Project Data Section

The Project Data provides more specific information that allows for a comparison of the proposed design with the minimum GB values.

1. Provide the following from the Design Criteria Information:
  - a. Current ADT (Year)
  - b. Design ADT (Year)
  - c. % Trucks
  - d. Design Speed
  - e. Existing Posted Speed Limit
  - f. Proposed Posted Speed Limit
  - g. Functional Classification.
2. Provide the GB values for the controlling design element(s) and the proposed values for the controlling design element(s) from the Design Exception Checklist form.

3. Provide the most recent construction estimate for the project.

Provide additional costs to meet minimum GB requirements, if known. If the costs are not known, discuss with the project team to determine if an additional cost estimate is needed to further explain the basis for the design exception. In certain cases, it may be appropriate to prepare a detailed explanation of the cost increase that could be expected to meet minimum GB standards in lieu of preparing an alternative design and obtaining the increased cost. When no estimate has been prepared, refer to “Basis for Exception”, Item 3.

### 17.7.3 Basis for Exception

The basis for the design exception provides the documentation that explains the need and justification for the design exception.

Address and thoroughly respond to the five items that form the basis for the design exception. Additional information to aid in responding to the five items is provided in the basis for exception below.

Restate Numbers 1-5 exactly as shown and provide responses:

1. *Describe the cross section, geometrics, access control, etc. of the existing roadway inside and outside the project limits.*

Provide a description of the existing conditions within the project limits. This information consists of a description of the roadway cross section, its geometry, community features, residences, businesses, natural environmental features, as well as posted speed limits and advisory posted speeds and helps to define the context within the project boundaries. Provide a similar description for the roadway outside of the project boundaries. This will assist in defining the context of the project surroundings. The information is then used to determine if a design exception in the project limits is compatible with the surrounding context of the roadway corridor.

2. *Describe any future plans for upgrading this roadway either at or in the vicinity of the project.*

Identify any upcoming NCDOT or municipal projects that are anticipated in the foreseeable future. Describe how future projects influence design decisions on this project. Note if these projects will improve controlling element(s) currently being requested as design exceptions. Note if adjacent projects have similar controlling elements that will require design exceptions. If no future projects are expected, indicate - “There are no future plans for upgrading this roadway either at or in the vicinity of this project”.

3. *Explain why it is not reasonable or feasible to meet operational performance characteristics defined by the minimum GB requirements.*

This is the core of the design exception. Address the need for the design exception and provide supporting documentation as to why the controlling design criteria cannot be met. Include a description of other alternatives that were considered before making the decision to pursue a design exception. Compare the impacts such as community, cost, environmental, usability by all modes, and/or right of way constraints. List and fully explain all data that reinforces the need for a design exception. Substantiate the reasons for the design exception with facts, historical data, cost estimates, context verification, etc. Include a detailed discussion of the long-term operational effects of allowing the design exception, especially as it relates to safety.

Note: For design speed exceptions, provide the length of the portion of the project with reduced design speed in relation to the length of the entire project. Describe the measures that will be used to transition from the reduced design speed to the recommended design speed or posted speed.

4. *Describe how the crash history relates to the proposed design exception. See current 3-year crash history, attached (number, severity, cause, comparison to statewide average, etc.). Explain how the crash history is relevant to the decision to request a design exception.*

Prior to the date of anticipated approval of the design exception, request the most recent three (3) years of crash data that is available. Document how past crashes relate to the controlling elements that do not meet AASHTO requirements. For example, accidents related to SSD may increase because SSD for proposed design speed is not being met. Conversely, accidents related to congestion could be expected to lessen because capacity of the roadway is being increased by the project, etc.

Crash rate comparisons are not required on bridge replacement projects unless there is a significant amount of roadway work beyond the bridge. Only a crash report is needed. Use engineering judgement to determine the level of detail needed on a project-by-project basis and document the decision.

5. *Describe any measures proposed to mitigate the design elements that are below standards.*

Consult with the Traffic Safety Unit regarding the design exception to determine appropriate mitigation measures. Lowering posted speeds by ordinance can be effective in many situations since design speed is a contributing component in over half of the controlling criteria. Unfortunately, this approach is typically not feasible from a project purpose or surrounding context perspective. An alternative to a statutory speed limit change is the posting of advisory signs. These signs warn motorists regarding the design limitations but do not require wholesale speed limit changes for a project. Consult with the Division and Regional Traffic offices when an advisory posting is being considered. Confirm the Division's commitment to review the project site for installation of advisory signs after the completion of the project and document this review in the design exception.

#### 17.7.4 Design Exception Request Submittal

Submit the Design Exception Request Form along with any accompanying documentation to the Roadway Design Unit Group Lead or the Division designee for review. The accompanying documentation includes but is not limited to the following: request memo, design exception form, design exception checklist, affected roadway plan sheets, and other diagrams demonstrating the exception and accident history.

## **NCDOT DESIGN EXCEPTION REQUEST**

F.A. Project No.:

State Project No.:

TIP No.:

County:

---

Design Exception Requested for: (*design speed, lane width, shoulder width, horizontal curve radius, superelevation rate, stopping sight distance for horizontal curves and crest vertical curves, maximum grade, cross slope, vertical clearance, and design loading structural capacity*)

Location of Design Controlling Criteria in Question:

---

### **PROJECT DATA**

Current ADT (Year):

Design ADT (Year):

% Trucks:

Design Speed:

Posted Speed Limit:

Functional Classification:

Minimum AASHTO Dimensions:

Dimensions Proposed:

Total Estimated Cost of Project:

Additional Cost to Meet Minimum Requirements:

---

### **BASIS FOR EXCEPTION**

1. *Describe the cross section, geometrics, access control, etc. of the existing roadway inside and outside the project limits.*
2. *Describe any future plans for upgrading this roadway either at or in the vicinity of the project.*

3. *Justify why it is not reasonable or feasible to meet safety and operational performance characteristics defined by the minimum AASHTO requirements. (Compare impacts such as community, cost, environmental, usability by all modes and/or ROW constraints.). Describe other alternatives that were considered before making the decision to pursue a design exception.*
  
4. *Describe how the crash history relates to the proposed design exception. See current 3-year crash history, attached (number, severity, cause, comparison to statewide average, etc.).*
  
5. *Describe any measures proposed to mitigate the design elements that are below standards.*

# 17.8 Example Forms

## 17.8.1 NCDOT Design Exception Request – Example 1



STATE OF NORTH CAROLINA  
DEPARTMENT OF TRANSPORTATION

ROY COOPER  
GOVERNOR

J.R. "JOEY" HOPKINS  
SECRETARY

MEMO TO: «Director\_of\_Technical\_Services» or «Division\_Engineer»

FROM: «State\_Roadway\_Design\_Engineer»  
Division Project Development Engineer

DATE:

SUBJECT: Project: 34178.1.3 (I-3306A) Orange County  
F. A. Project: IMS-040-4(148)259  
Widening of I-40 from I-85 to the Durham County Line

**Request for Design Exception**

This is a request for a design exception for stopping sight distance for horizontal curves and shoulder width. See attachment for pertinent information.

If you have any questions, please contact \_\_\_\_\_, Project Manager, at ( \_\_\_\_\_ ) \_\_\_\_\_ - \_\_\_\_\_.

\_\_\_\_\_  
Engineer of Record (licensed PE)

«State\_Roadway\_Design\_Engineer»  
(for Centrally managed projects only)

Attachment  
ec: Project Manager

APPROVED: \_\_\_\_\_

DATE: \_\_\_\_\_

ec: «Division\_Engineer»  
Division Traffic Engineer  
Regional Traffic Engineer w/Attachment

NCDOT DESIGN EXCEPTION REQUEST

F.A. Project No.: IMS-040-4(148)259

State Project No.: 34178.13

TIP No.: I-3306A

County: Orange

Design Exception Requested for: *(shoulder width, stopping sight distance for horizontal curves)*

Location of Design Feature in Question:

- 1) -L- Sta. 10+00.00 to 91+86 (Median Shoulder)
- 2) -L- Sta. 10+57.55 (Median Shoulder)
- 3) Horizontal curve from -L- Sta. 67+55.32 to 85+65.12 (SSD)
- 4) -L- Sta. 142+62 to 299+38 (Median Shoulder)
- 5) -L- Sta. 219+92.11 (Median Shoulder)
- 6) Horizontal curve from -L- Sta. 271+25.48 to 238+26.93 (SSD)
- 7) -L- Sta. 327+62 to 558+68.71 (Median Shoulder)
- 8) Horizontal curve from -L- Sta. 352+28.83 to 370+93.06 (SSD)  
(Meets Posted Speed of 65mph)
- 9) Horizontal curve from -L- Sta. 411+67.22 to 431+73.25 (SSD)
- 10) Horizontal curve from -L- Sta. 441+75.89 to 461+76.88 (SSD)
- 11) -L- Sta. 468+48.07 (Median Shoulder)
- 12) -L- Sta. 540+69.63 (Median Shoulder)

PROJECT DATA

Current ADT (Year): 72,335

Design ADT (Year): 90,185

% Trucks: 9%

Design Speed: 70 mph

Posted Speed: 65 mph

Functional Classification: Interstate

Minimum AASHTO Dimensions:

Dimensions Proposed:

Median Shoulder = 10'  
Horiz. SSD = 730'

- 1) -L- Sta. 10+00.00 to 91+11.31  
Median Shoulder = 9.75'
- 2) -L- Sta. 10+57.55  
Median Shoulder = 8.16' left/ 8.92' right
- 3) -L- Sta. 67+55.03 to 85+65.12  
Horiz. SSD = 568' (55mph)
- 4) -L- Sta. 142+37.18 to 299+63.50  
Median Shoulder = 9.75'



## Minimum AASHTO Dimensions:

Median Shoulder = 10'  
 Horiz. SSD = 730'

## Dimensions Proposed:

- 5) -L- Sta. 219+92.11  
 Median Shoulder = 8.83' left/ 8.67' right
- 6) -L- Sta. 271+25.48 to 283+26.93  
 Horiz. SSD = 602' (60 mph)
- 7) -L- Sta. 327+37.18 to 558+68.71  
 Median Shoulder = 9.75'
- 8) -L- Sta. 352+28.83 to 370+93.06  
 Note – Meets Posted Speed
- 9) -L- Sta. 411+67.22 to 431+73.25  
 Horiz. SSD = 602' (60 mph)
- 10) -L- Sta. 441+78.89 to 461+76.88  
 Horiz. SSD = 695' (65 mph)
- 11) -L- Sta. 468+48.07  
 Median Shoulder = 7.5' left/ 8.5' right
- 12) -L- Sta. 540+69.63  
 Median Shoulder = 7.83' left/ 7.25' right

Total Estimated Cost of Project: \$175,600,000

Additional Cost to Meet Minimum AASHTO Requirements: (See Item #3 in Basis for Exception)

---

BASIS FOR EXCEPTION

1. *Describe the cross-section, geometrics, access control, etc. of the existing roadway inside and outside the project limits.*

The I-40 corridor from Greensboro to Raleigh is classified as an interstate and has full control of access and is currently posted 65 mph. The eastern end of the project connects to a section of I-40 that was constructed under TIP I-3306B. The typical section for that project was a 6-lane divided facility with median concrete barrier. The median shoulders are approximately 9.75' and total outside shoulders are 12' wide, 10' of which is paved. At the western end of the project, I-40 connects to I-85 at the I-40/I-85 split. The typical section for I-40/I-85 from Greensboro to just west of the I-3306A project is an 8-lane divided facility with concrete barrier, 12' lanes, 10' median shoulders, and 10' outside paved shoulders.

The I-3306A project proposes to widen I-40 from a 4-lane divided facility with a 46' median to a 6-lane divided facility with median concrete barrier. The proposed typical section will be compatible with what was constructed under I-3306B and with the exception of the I-40/I-85 interchange area will separate opposing traffic along I-40 with a concrete barrier from Greensboro to NC 147 in Durham.

2. *Describe any future plans for upgrading this roadway either at or in the vicinity of the project.*

*Interstate 40 connects with and joins I-85 at the western end of the I-3306A project. TIP Project I-0305 adjoins project I-3306A at the western end of I-3306A. The I-0305 project is*

*non-committed and unfunded, as identified in the current State Transportation Improvement Program. This project will widen approximately 7 miles of I-85 from SR 1006 (Orange Grove Road) in Orange County to SR 1400 (Sparger Road) in Durham County from a 4-lane divided to 6-lane divided facility.*

3. *Justify why it is not reasonable or feasible to meet safety and operational performance characteristics defined by the minimum AASHTO requirements. (Compare impacts such as community, cost, environmental, usability by all modes and/or ROW constraints.). Describe other alternatives that were considered before making the decision to pursue a design exception.*

#### Median Shoulder Width

The minimum AASHTO requirement for median width on a freeway with 6 or more lanes is 22' and the minimum median shoulder width is 10'. AASHTO and NCDTO guidance indicate 12' should be considered when truck volumes exceed 250 vehicles/hour but is not required. The proposed typical section includes a 22' median. However, the proposed median shoulder width at Sites #1, #4 and #7 is approximately 9.75' requiring 3" of widening to meet the AASHTO minimum. The existing bridges are being retained at Sites #2, #5, #11 and #12. The positive protection needed for the bridge piers results in further reduction of the shoulder widths for short segments. The proposed median shoulder widths in these locations are below.

##### Site #2

The left and right median shoulder widths under the SR 1006 (Orange Grove Road) bridge at -L- station 10+57.55 are 8.16' and 8.92', respectively.

##### Site #5

The left and right median shoulder widths under SR 1732 (New Hope Church Road) bridge at -L- station 219+92.11 are 8.83' and 8.67', respectively.

##### Site #11

The left and right median shoulder widths under the SR 1732 (Sunrise Road) bridge at -L- station 468+48.07 are 7.5' and 8.5', respectively.

##### Site #12

The left and right median shoulder widths under the SR 1734 (Erwin Road) bridge at -L- station 540+69.63 are 7.83' and 7.25', respectively.

The project proposes to leave the existing concrete pavement in place. The widening required for these exceptions to meet the 10' minimum would result in placing a vehicle's wheel path close enough to the existing concrete pavement joint to create a long-term maintenance concern. A spread median is proposed at the Old NC 86 interchange and the Norfolk Southern Railroad bridge replacement allowing the median shoulders to be increased to meet the minimum.

#### Horizontal Stopping Sight Distance

The minimum AASHTO requirement for horizontal stopping distance for a design speed of 70 mph is 730'. There is insufficient horizontal stopping sight distance in the median travel lane for five curves along the proposed horizontal alignment. Two of these meet the proposed posted speed of 65 mph. The median shoulder in the direction of travel requires widening for the entire length of the curve. The horizontal stopping sight distance provided, affected stations and width of additional median widening required for each exception location is listed below.

##### Site #3

Approximately 568' of horizontal stopping sight distance is provided for the median eastbound lane from -L- station 67+55.32 to 85+65.12. An additional 10.21' of median widening is required.

Site #6

Approximately 602' of horizontal stopping sight distance is provided for the median westbound lane from -L- station 271+25.48 to 283+26.93. An additional 7.21' of median widening is required.

Site #8

Approximately 698' of horizontal stopping sight distance is provided for the median eastbound lane from -L- station 352+28.83 to 370+93.06. An additional 2.21' of median widening is required. Note: Meets the posted speed.

Site #9

Approximately 602' of horizontal stopping sight distance is provided for the median eastbound lane from -L- station 411+67.22 to 431+73.25. An additional 7.21' of median widening is required.

Site # 10

Approximately 695' of horizontal stopping sight distance is provided for the median westbound lane from -L- station 441+75.89 to 461+76.88. An additional 2.21' of median widening is required. Note: Meets the posted speed.

Elimination of the design exceptions for horizontal stopping sight distance requires variable widening and lane shifts throughout the project limits. As noted previously, the location of the wheel path as it relates to the concrete pavement joints is critical. The additional width required to meet the minimum and avoid this conflict would necessitate modifications to existing concrete slope protection at several bridge locations, increase additional right of way impacts or require the use of mitigating design features such as retaining walls. These efforts would significantly increase the cost of the project.

Meeting the AASHTO minimum for horizontal clearance for Sites #2, #5, #12 and #13 would require shifting traffic, removal of a portion of the concrete slope protection on the outside and the introduction of retaining walls. There are existing bridge piers on the outside shoulders at Site#9 which would further restrict any shoulder widening at that location. As noted in the earlier median shoulder discussion, traffic shifts would be prohibited due to long term maintenance concerns at the concrete pavement joints. At all minimum AASHTO requirements.

4. Describe how the crash history relates to the proposed design exception. See current 3-year crash history, attached (number, severity, cause, comparison to statewide average, etc.).

There were 898 accidents reported between January 1, 2018, and December 31, 2020, within the limits of the project. Of these, 265 were within the tangent sections of the horizontal alignment, 389 were within the curves of the horizontal alignment, and 67 occurred near bridge underpass. Overall, 450 accidents were rear end accidents due to slow or stopped traffic, 175 were caused by sideswipe and 124 were due to striking a fixed object. The remaining 149 accidents involved animals, movable objects, parked vehicles, pedestrians or running off the road. Eighty three percent (83%) or 744 of the total accidents involved fatalities.

Five horizontal curves will not meet AASHTO requirement for stopping sight distance after the median barrier is installed. In these locations, there were 154 accidents, 2 of which involved injuries. Two of these curves will meet the proposed posted speed of 65 mph. In the remaining three curves, there were 93 reported accidents with one fatality.

The crash rate of 76.49 for I-40 within the project limits of I-3306A is lower than the 2019 statewide average of 121.85. The proposed additional lanes added to I-40 will alleviate overall traffic congestion. This combined with the new inside and rebuilt outside shoulders, guardrail, etc. should serve to increase safety through the project corridor.

5. *Describe any measures proposed to mitigate the design elements that are below standards.*

Advanced stopped/slow traffic signs should be considered along the curves that do not meet the horizontal stopping sight distance required to provide better delineation and guidance for motorists. The traffic forecast indicates that more than the one lane proposed under the I-3306A project is needed. The additional lane will likely require a complete reconstruction of I-40 through this corridor but was not feasible at this time due to limited funding.

Example



17.8.2 NCDOT Design Exception Checklist – Example 1

**DESIGN EXCEPTION PROCESS CHECKLIST**

Date: \_\_\_\_\_ Design Engineer: \_\_\_\_\_  
 TIP No: I-3306A Functional Classification: Interstate  
 Posted Speed: 65 mph Terrain: Rolling

*Note: For projects with a design speed of less than 50 mph, a design exception request will only be required for items A and B. However, all 10 controlling criteria shall be completed. In the Exception Req'd column, indicate Yes or No as to whether an exception is needed.*

<u>Controlling Criteria requiring review for Design Exception</u>	<u>Prop Design</u>	<u>AASHTO Std</u>	<u>Exception Req'd</u>
A) Design Speed <sup>1</sup>	<u>70 mph</u>	<u>70 mph</u>	<u>No</u>
B) Structural Capacity <sup>2</sup>	<u>HL-93</u>	<u>HL-93</u>	<u>No</u>
C) Lane Width	<u>12'</u>	<u>12'</u>	<u>No</u>
D) Shoulder Width	<u>14' Outside</u>	<u>14' Outside</u>	<u>No</u>
	<u>7.25'- 9.75** Median</u>	<u>10' Median</u>	<u>Yes</u>
E) Maximum Grade	<u>3.4326%</u>	<u>4%</u>	<u>No</u>
F) Min. Horizontal Curve Radius	<u>2,550'</u>	<u>1,810'</u>	<u>No</u>
	<u>568' (55mph)</u>		<u>Yes</u>
	<u>602' (60mph)</u>		<u>Yes</u>
	<u>602' (60mph)</u>		<u>No</u>
	<u>695' (65mph) #</u>		<u>No</u>
G) Horizontal SSD	<u>698'(65mph) #</u>	<u>730'</u>	<u>No</u>
H) Vertical SSD (Crest Only)	<u>&gt;730' (Exist)</u>	<u>730'</u>	<u>No</u>
I) Pavement Cross Slope	<u>2%</u>	<u>2%</u>	<u>No</u>
J) Superelevation	<u>7%</u>	<u>8%</u>	<u>No</u>
K) Vertical Clearance	<u>16'-7" WBL</u>	<u>17***</u>	<u>No</u>
	<u>16'-8" EBL</u>	<u>17***</u>	

\* Proposed 9.75' median width due to widening too median. Only a 22' Median (9.75' to face of barrier) can be achieved. Proposed work ties to an existing typical section with 22' median with 9.5' to face of barrier. Variable median width of 7.25'-8.92' at existing pier locations

**Listed below are the known non-complying items not requiring an approved design exception.**

- (1) The design speed should be the greater of the minimum design speed for the facility type or the anticipated posted speed plus 5 mph. An element may not require a design exception if the

element meets the posted speed limit. Coordinate with the Roadway Design Unit Group Lead or Division designee to confirm that a design exception is not needed.

- (2) The Structures Management Unit will check the structural capacity (load rating). Coordinate with the appropriate Structures Management Unit engineer to determine if a design exception is needed.

\*\* The AASHTO minimum for an existing bridge to remain in-place is 16'.

# Meets posted speed.

Example

17.8.3 NCDOT Design Exception Request SRT – Example 2



STATE OF NORTH CAROLINA  
DEPARTMENT OF TRANSPORTATION

ROY COOPER  
GOVERNOR

J.R. "JOEY" HOPKINS  
SECRETARY

MEMO TO: «Director\_of\_Technical\_Services» or «Division\_Engineer»

FROM: «State\_Roadway\_Design\_Engineer»  
Division Project Development Engineer

DATE:

SUBJECT: Project: 38616.3.FD1 (B-4846) Wilkes County  
F. A. Project: BRZ-2418(1)  
Bridge No. 5 over Little Hunting Creek

**Request for Design Exception**

This is a request for a design exception for maximum grade, minimum horizontal curve radius, and stopping sight distance for horizontal curves. See attachment for pertinent information.

If you have any questions, please contact \_\_\_\_\_, Project Manager, at ( ) - .

\_\_\_\_\_  
Engineer of Record (licensed PE)

«State\_Roadway\_Design\_Engineer»  
(for Centrally managed projects only)

Attachment  
cc: Project Manager

APPROVED: \_\_\_\_\_

DATE: \_\_\_\_\_

cc: «Division\_Engineer»  
Division Traffic Engineer  
Regional Traffic Engineer w/Attachment

NCDOT DESIGN EXCEPTION REQUEST

F.A. Project No.: BRZ-2418(1) State Project No.: 38616.3.FD1

TIP No.: B-4846 County: Wilkes

Design Exception Requested for: *(maximum grade, minimum horizontal curve radius, and stopping sight distance for horizontal curves)*

Location of Design Feature in Question:

Maximum Grade: From -L- Station 12+20 to -L- Station 12+62 for a distance of approximately 42’.

Minimum Horizontal Curve Radius: From -L- Station 15+85.17 to -L- Station 16+25 for a distance of approximately 40’.

Horizontal Stopping Sight Distance: From -L- Station 15+85.17 to -L- Station 16+25 for a distance of approximately 40’.

PROJECT DATA

Current ADT (2014): 60

Design ADT (2034): 97

% Trucks: 5%

Design Speed: 60 mph Posted Speed: 55 mph (Statutory)

Functional Classification: Local Rural Subregional Tier

**Minimum AASHTO Dimensions:**

Design Speed = 60 mph

Maximum Grade = 6%

**Dimensions Proposed:**

Design Speed = 45 mph

Maximum Grade = 9%

**Minimum AASHTO Dimensions:**

Design Speed = 60 mph

Minimum Horizontal Curve Radius = 1500’

**Dimensions Proposed:**

Design Speed = 25 mph

Minimum Horizontal Curve Radius = 200’

**Minimum AASHTO Dimensions:**

Design Speed = 60 mph

Horizontal Stopping Sight Distance = 570’

**Dimensions Proposed:**

Design Speed = 30 mph

Horizontal Stopping Sight Distance = 200’

**Minimum AASHTO Dimensions:**

Design Speed = 60 mph

Vertical Stopping Sight Distance = 570’

Total Estimated Cost of Project: \$675,000

Additional Cost to Meet Minimum Subregional Tier Requirements: N/A (See Item #3 in Basis for Exception)



### BASIS FOR EXCEPTION

1. *Describe the cross-section, geometrics, access control, etc. of the existing roadway inside and outside the project limits.*

The existing road at the bridge has a pavement width of 18' with 3' to 4' grass shoulders throughout the limits of the project. The existing bridge has a clear roadway width of 18.7'. The horizontal alignment is tangent on the bridge preceded by 6000' radius curve on the approach and a 200'-300' radius compound curve approximately 109' beyond the end of the bridge. The vertical alignments is rolling with 6%-9% grades east and west of the bridge, respectively. There is no control of access along the roadway.

2. *Describe any future plans for upgrading this roadway either at or in the vicinity of the project.*

NCDOT Division 11 currently has no plans to upgrade this roadway. There are no other projects in the vicinity of this project.

3. *Justify why it is not reasonable or feasible to meet safety and operational performance characteristics defined by the minimum AASHTO requirements. (Compare impacts such as community, cost, environmental, usability by all modes and/or ROW constraints.). Describe other alternatives that were considered before making the decision to pursue a design exception.*

The proposed design calls for 10' lanes with 3' paved shoulders. Guardrail will be added to protect the bridge approaches and shoulders will be widened an additional 3' in guardrail locations. The proposed design calls for paving out to the limits of the guardrail which increases the paved shoulder to 3'-10" at the bridge tie-ins. The proposed structure is in the same general location horizontally and approximately 4.5' +/- higher vertically. To improve the maximum grade to meet 60 mph, the grade west of the beginning of the bridge would need to be replaced with a 6% grade requiring the extension of the project beginning approximately 120' and raising the grade over the structure approximately 10'.

The minimum horizontal curve radius and horizontal stopping sight distance not meeting 60 mph design speed occur at the tie-in near the end of the project. To improve the horizontal curve radius and horizontal stopping sight distance, the existing horizontal curve would need to be replaced with a 1500' radius curve which would require the roadway to be constructed on new alignment resulting in significantly increased impacts to adjacent properties.

Cost estimates for the alternates to meet 60 mph were not requested due to the severe impacts on the surrounding properties. This type of improvement is not consistent with the existing topography and surrounding area along SR 2418. The proposed design elements along the project satisfy a 60 mph design speed except for the maximum grade, minimum horizontal curve radius, sag vertical curve K, horizontal stopping sight distance, and vertical stopping sight distance. (See the attached design exception process checklist)

4. *Describe how the crash history relates to the proposed design exception. See current 3-year crash history, attached (number, severity, cause, comparison to statewide average, etc.).*

No accidents were reported in the vicinity of the bridge during the period from August 1, 2010 through July 31, 2013.

5. *Describe any measures proposed to mitigate the design elements that are below standards.*

Upon completion of the project, Jimmy Hamrick, PE, Regional Traffic Engineer, will evaluate the need for mitigating measures in the vicinity of the bridge.

Example

17.8.4 NCDOT Design Exception Checklist SRT – Example 2

**DESIGN EXCEPTION PROCESS CHECKLIST**

Date: \_\_\_\_\_ Design Engineer: \_\_\_\_\_

TIP No: B-4846 \_\_\_\_\_ Functional Classification: Local – Rural  
Subregional Tier \_\_\_\_\_

Posted Speed: 55 mph (Statutory) \_\_\_\_\_ Terrain: Rolling \_\_\_\_\_

*Note: For projects with a design speed of less than 50 mph, a design exception request will only be required for items A and B. However, all 10 controlling criteria shall be completed. In the Exception Req'd column, indicate Yes or No as to whether an exception is needed.*

<b><u>Controlling Criteria requiring review for Design Exception</u></b>	<b><u>Prop Design</u></b>	<b><u>AASHTO Std(a)</u></b>	<b><u>Subregional Tier</u></b>	<b><u>Exception Req'd</u></b>
A) Design Speed <sup>1, a</sup>	60 mph	60 mph	60 mph	No/No
B) Structural Capacity <sup>2, b</sup>	HL-93	HL-93	HL-93	No/No
C) Lane Width	10'	11'	10'	Yes/No
D) Shoulder Width	3'	2'	3'	No/No
E) Maximum Grade	8.53% <sup>c</sup>	6%	6%	Yes/Yes
F) Min. Horizontal Curve Radius	200' <sup>d</sup>	1500'	1500'	Yes/Yes
G) Horizontal SSD	200' <sup>e</sup>	570'	570'	Yes/Yes
H) Vertical SSD (Crest Only)	N/A	570'	570'	No/No
I) Pavement Cross Slope	2%	2%	2%	No/No
J) Superelevation	0.04	0.04	0.04	No/No
K) Vertical Clearance	NA	NA	NA	NA

- (a) The AASHTO STD. as it relates to the design speed should be equal to the higher of either the posted speed or the minimum “Greenbook” value for design speeds.
- (b) Structure Design’s responsibility - be sure they have checked for need of design exception.
- (c) This element meets 45 mph design speed.
- (d) This element meets 25 mph design speed.
- (e) This element meets 30 mph design speed.

**Listed below are the known non-complying items not requiring an approved design exception.**

- (1) The design speed should be the greater of the minimum design speed for the facility type or the anticipated posted speed plus 5 mph. An element may not require a design exception if the element meets the posted speed limit. Coordinate with the Roadway Design Unit Group Lead or Division designee to confirm that a design exception is not needed.

- (2) The Structures Management Unit will check the structural capacity (load rating). Coordinate with the appropriate Structures Management Unit engineer to determine if a design exception is needed.

Example



### 17.8.5 NCDOT Design Exception Request Design Speed – Example 3



## STATE OF NORTH CAROLINA DEPARTMENT OF TRANSPORTATION

ROY COOPER  
GOVERNOR

J.R. "JOEY" HOPKINS  
SECRETARY

MEMO TO: «Director\_of\_Technical\_Services» or «Division\_Engineer»

FROM: «State\_Roadway\_Design\_Engineer»  
Division Project Development Engineer

DATE:

SUBJECT: Project: 32835.1.1 (B-3045) Stokes County  
F. A. Project: BRSTP-89(5)  
Bridge No. 17 over Dan River and approaches on NC 89

#### Request for Design Exception

This is a request for a design exception to reduce the design speed from 55 mph to 40 mph. See attachments for pertinent information.

If you have any questions, please contact \_\_\_\_\_, Project Manager, at ( \_\_\_\_\_ ) \_\_\_\_\_.

\_\_\_\_\_  
Engineer of Record (licensed PE)

«State\_Roadway\_Design\_Engineer»  
(for Centrally managed projects only)

Attachment  
cc: Project Manager

APPROVED: \_\_\_\_\_

DATE: \_\_\_\_\_

cc: «Division\_Engineer»  
Division Traffic Engineer  
Regional Traffic Engineer w/Attachment

NCDOT DESIGN EXCEPTION REQUEST

---

F.A. Project No.: BRSTP-89(5)                  State Project No.: 32835.1.1  
 TIP No.: B-3045    County: Stokes

---

Design Exception Requested for: Design Speed  
 Location of Design Feature in Question: Entire Project

---

PROJECT DATA

Current ADT (2003): 910                                  Design ADT (2025): 1415  
 % Trucks: 6%                                  Design Speed: 40 mph    Posted Speed: 55 mph (Statutory)  
 Functional Classification: Rural Major Collector  
 Minimum AASHTO Dimensions: Design Speed = 40 mph  
 Dimensions Proposed: Design Speed = 40 mph  
 Total Estimated Cost of Project: \$1,850,000  
 Additional Cost to Meet Minimum Requirements: N/A (See Item #3 in Basis for Exception)

---

BASIS FOR EXCEPTION

1. *Describe the cross-section, geometries, access control, etc. of the existing roadway inside and outside the project limits.*

The existing roadway is 20’ wide with 6’ to 8’ shoulders throughout the proposed project limits. The existing bridge is 379’ long and 28’ wide. The eastern approach and existing bridge are on a horizontal tangent, and the western approach is on a 12-degree curve. The speed limit is 55 mph, by statute since the speed limit is not posted. There is no control of access along the roadway.

2. *Describe any future plans for upgrading this roadway either at or in the vicinity of the project.*

There are no future plans for upgrading this roadway either at or in the vicinity of this project.

3. *Justify why it is not reasonable or feasible to meet safety and operational performance characteristics defined by the minimum AASHTO requirements. (Compare impacts such as*

*community, cost, environmental, usability by all modes and/or ROW constraints.). Describe other alternatives that were considered before making the decision to pursue a design exception.*

To meet a posted speed of 55 mph, the horizontal curve radius at the beginning of the project would have to be flattened to approximately 5 degrees, requiring the alignment to be shifted further south, increasing the impacts to a parallel stream and impact several buildings on the southwest side of the current alignment. Altering the vertical design to meet a 55 mph design speed would have comparable negative impacts to the adjacent properties and the parallel stream. In addition, changing the proposed grades would greatly increase the difficulty of maintaining traffic during construction. The proposed design provides a design speed of 40 mph, the recommended AASHTO minimum for this facility type, with some design elements satisfying 40 to 55 mph design speeds. (See the Design Exception Process Checklist for more specific information). The proposed design is compatible with existing NC 89 outside of the project limits and will provide an equal or improved alignment as compared to the existing roadway.

4. *Describe how the crash history relates to the proposed design exception. See current 3-year crash history, attached (number, severity, cause, comparison to statewide average, etc.).*

There was one accident reported in the vicinity of the bridge during the 3-year period from April 1, 1998 to March 31, 2001. A vehicle on SR 1504 (Lynchburg Road) approaching NC 89 failed to stop due to brake failure and the driver attempted to make a right turn onto NC 89. The vehicle's momentum carried it into the left lane, and it struck the bridge rail.

5. *Describe any measures proposed to mitigate the design elements that are below standards.*

A 40 mph advisory sign is posted in the vicinity for the NC 89/SR 1504 intersection. Upon completion of the project, Vickie L. Embry, Regional Traffic Engineer, will evaluate the need for additional advisory postings.

17.8.6 NCDOT Design Exception Checklist Design Speed – Example 3

**DESIGN EXCEPTION PROCESS CHECKLIST**

Date: \_\_\_\_\_ Design Engineer: \_\_\_\_\_  
 TIP No: B-3045 Functional Classification: Rural Major Collector  
 Posted Speed: 55 mph (Statutory) Terrain: Rolling

*Note: For projects with a design speed of less than 50 mph, a design exception request will only be required for items A and B. However, all 10 controlling criteria shall be completed. In the Exception Req'd column, indicate Yes or No as to whether an exception is needed.*

<u>Controlling Criteria requiring review for Design Exception</u>	<u>Prop Design</u>	<u>AASHTO Std</u>	<u>AASHTO Std</u>	<u>Exception Req'd (40 mph/55 mph)</u>
A) Design Speed <sup>1</sup>	40 mph	40 mph	55 mph	Yes
B) Structural Capacity <sup>2</sup>	HL-93	HL-93	HL-93	No/No
C) Lane Width	11'	11'	11'	No/No
D) Shoulder Width	6'	5'	5'	No/No
E) Maximum Grade	3.0067%	8%	7%	No/No
F) Min. Horizontal Curve Radius	509.30 <sup>a</sup>	510'	1065'	No/Yes
G) Horizontal SSD	>305'	305'	495'	No/Yes
H) Vertical SSD (Crest Only)	316'	305'	495'	No/Yes
I) Pavement Cross Slope	2%	2%	2%	No/No
J) Superelevation	0.06	<0.08	<0.08	No/No
K) Vertical Clearance	N/A(River)	N/A(River)	N/A(River)	N/A

a) The slight difference in the values for the proposed radius and the AASHTO requirement 40 mph (0.07) is a result of the switch to measuring horizontal curvature by radius instead of degree of curve and the rounding associated with that conversion.

**Listed below are the known non-complying items not requiring an approved design exception.**

- (1) The design speed should be the greater of the minimum design speed for the facility type or the anticipated posted speed plus 5 mph. An element may not require a design exception if the element meets the posted speed limit. Coordinate with the Roadway Design Unit Group Lead or Division designee to confirm that a design exception is not needed.
- (2) The Structures Management Unit will check the structural capacity (load rating). Coordinate with the appropriate Structures Management Unit engineer to determine if a design exception is needed.